

The
MODERN
GUNSMITH

HOWE



THE MODERN GUNSMITH

A Guide for the Amateur and Professional Gunsmith in the
Design and Construction of Firearms, with Practical
Suggestions for All Who Like Guns

By

JAMES VIRGIL HOWE

Formerly in Charge of the Small-Arms Experimental Division at
the United States Frankford Arsenal; also Formerly of
Griffin & Howe, Inc., of New York City

IN TWO VOLUMES

Revised Edition, With SUPPLEMENT Giving Latest Developments

Volume I



FUNK & WAGNALLS COMPANY
NEW YORK and LONDON



The attic workshop, where one spends many leisure hours

COPYRIGHT, 1934, 1937, AND 1941, BY
FULK & WAGNALLS COMPANY

Printed in the United States of America

18

VOLUME I

Supplement

THE MODERN GUNSMITH

COPYRIGHT 1941, AND 1954

Copyright Under the Articles of the Copyright Convention
of the Pan-American Republics and the United States

DEDICATED TO
COLONEL TOWNSEND WHELEN,
TIRELESS WORKER, MASTER RIFLEMAN, AND HUNTER;
ABOVE ALL, A MAN AND A FRIEND

PREFACE

IT IS NOT without some misgiving that I venture on this, my first effort to write a book. In the first volume I have endeavored to keep in mind the enthusiastic but oftentimes struggling amateur gunsmith, and the book is offered as an attempt to make him independent of outside help. In its arrangement I have followed the method which at this time appears best suited to convey a clear idea of constructive forms of gun work.

The second volume aims to be a wider and deeper development of the material introduced in the first. It is my hope that it will lead the amateur into the theoretical and practical science of gunmaking, and be "a light to his path and a lamp to his feet" all the fascinating way.

The work as a whole is written in the hope, not that masters will arise from these teachings, but that latent skill will be aroused and self-reliance encouraged. It is almost certain that as time advances some of the drawings and formulas will be revised; but until then, I feel confident that they will be of the utmost service to the student. Undoubtedly, much will be found in these pages that is obvious to the more experienced mechanic, but if I have succeeded in lucidly conveying the first principles of gunmaking to the beginner, I shall feel satisfied.

The gun in all its forms is only an implement, but in its making it has become a highly specialized work of art, and few trades require such an extensive knowledge of mechanics. The gunmaker must also be not only a tool maker but an artizan who can adapt himself to almost any type of work. It is the ingenious man who will go farthest in this work, for it has unlimited possibilities; and as he advances to the problems of the second volume it will become more interesting.

It is with a feeling greatly resembling regret that I write the word "finis" to these volumes. Their creation has been an intriguing task, and has caused me to walk anew the beguiling path upward from my amateur days. And much remains unsaid, for it is impossible to corral all the vital information that has been gained in a lifetime of gunmaking, or to stop writing of a science which never has stood still and never will.

It would be impossible to explore a field so wide and diversified, even as insufficiently as I have done it, without the aid of knowledge and experience other than my own. I therefore take pleasure in acknowledging the valuable assistance rendered me by such well-known and authoritative sportsmen and technicians as Colonel Townsend Whelen, Mr. T. G. Samworth, Captain G. A. Woody, Mr. R. J. Kornbrath, and Mr. Austin G. Hale. And for their contribution of illustrations I am indebted to Dr. Dayton C. Miller, McGraw Hill Book Company, Westley Richards & Company, Ltd., the Lyman Gunsight Corporation, Parker Brothers, Waterbury Farrel Foundry Company, Remington Arms Company, the Cleveland Twist Drill Company, Hendey Machine Company, Pratt & Whitney Company. All these friends have been generous with their hard-acquired information, and we shall always be their debtors. In other days such "secrets of the craft" would have been jealously guarded by their discoverers. Today the greatest have not withheld their kindly hands.

Old Omar Khayyam has these lines in the Rubaiyat:

I often wonder what the vintners buy,
One-half so precious as the stuff they sell.

I feel the same way about gunmaking. What business is so fascinating as that which makes the things one loves, what clientele so appreciative and loyal as sportsmen at their happiest and best?

May I ask the reader's pardon for incompleteness, for oversights, for possible errors, and may I ask of him tenacity, perseverance and patient hard work, that this text-book may not have been written in vain?

JAMES VIRGIL HOWE

Cleveland, Ohio, June, 1934

CONTENTS — Volume I

CHAPTER	PAGE
Introduction	3
I — The Workshop, Tools and General Equipment	9
The work bench—Necessary tool layout—Alcohol lamp—Angle plate—Anvil—Arbors—Arbor press—Bench stops—Bench grinders—Bench or surface plate—Bits—Bevel protractor—Calipers—Catalogs—Checkering tools—Chisels—Clamps—Countersinks—Dies—Spring dividers—Drill sets—Drill and wire gauges—Drill press—Sanding drum—Draw-knife—Electric soldering iron—Files—File card—File handles—Furnace—Gauges—Hammers—Indicators—Ladle—Lathe—Lathe dog—Mallet—Micrometers—Muzzle reamers—Magnifying glass—Miter box—Oilstones—Oil cans—Pans—Parallels—Plates—Planes—Polishing wheels—Tap wrenches—Pliers—Reamers—Saws—Scribers—Straight-edge—Scratch brush—Screw-drivers—Spring winding tool—Steel letters and figures—Scales—Weighing—Stools—Squares—Templets—Electric motor—V-blocks—Vise jaws—Welding outfit—Wrenches.	
II — Special Home-made Tools and Equipment	29
The gunsmith—The trade of a gunsmith—Shotgun or rifle maker—Checkering stand and cradles in use—Checkering tools—Border tools—English type of tools—Motor grinder—Emery wheels—Fine circular wire wheels—Felt wheels—Woods for disc grinding—Chuck for motor grinder—Wooden laps—Wood chisels—Suggestions for making bottoming chisels—Forging and heat-treatment for chisels—Handles for wood chisels and ferrules—Importance of good screw-drivers—Auger screw-drivers used with brace—Suggestions for constructing screw-drivers—Hardening—Gun brace—Method of clamping brace—Rifle holder: Methods of making—Vise blocks—Hard wooden blocks—Copper vise jaws—Leather facing for vise jaws, lead jaws, etc.—Clamps, butt clamps—Importance of necessary tools.	
III — Materials, Metals, and Supplies	41
Materials used by gunmaker—Catalogs—Precision in gun work—Tool steel, cold-drawn steel, drill rods, spring steel, steel tubing, steel spring wire—Machine screws and sizes—Brass, copper, lead, solder, soldering salts, emery cloth, sandpaper, fiber, glue, felt, buffalo horn, pumice powder, rottenstone powder, wood screws, acids, varnishes, rubbing oils, linseed oil, varnish removers, beeswax, ivory, charcoal, lacquers for metal, rouge or ferric oxid, Prussian blue, bone-black, water, woods, shellac, lacquer, gun oil, lard oil, sperm oil, etc.	
IV — The Use of Tools	49
Wood-working tools—Chisels: their use and kinds in gun work; grinding of such tools; stoning for keen edges—Buffing wheel—Method of placing sharp run edges for cutting—The draw-knife and its uses—Planes: sharpening on the stone: adjusting the blade—Rasps: woods they are used on—Saws: sharpening of saws, instruction in their use, blades for saws, frames—The spoke-shave—Wood bits, cutter bits, the Forstner bit—Selection of brace—Drills and drilling: the twist drill, grinding of drills, drill gauges used in grinding drills, drills for glass, drill troubles, keeping drills sharp, lubricants used—Drilling heat-treated steel—Grinding drills for wood—The drill press, set-ups on drill press, method of cutting out inlays on drill press—Files: their importance in the trade of a gunsmith—Terms used for file—First steps in the use of a file—Grinding: speed of grinders, their uses, fixture attached to grinder for grinding tools—Grades and grains of grinding wheels—Selection of wheels for grinding, mount-	

ing grinding wheels—Laps and lapping: abrasives for lapping, charging caps, dry lapping, laps for flat surfaces, diamond laps, lapping chambers—Reamers and their uses—Screw-drivers and bits—Soldering fluxes—Taps and tapping—Lathe turning tools and tool grinding—Use of the alcohol lamp and Bunsen burner—Forge and anvil—Micrometer and its use—Oilstones: care of oilstones.

- V — Reading and Making Drawings** 69
- What a mechanical drawing is—Views of drawings—Importance of having larger size—Prints—Technical lines—Finished lines—Instruments used in drawing—Paper—Thumb tacks—Drawing board—Pencils, erasers, triangles, ink, protractor, scales—Irregular curves—Title headings—Lettering.
- VI — Safety With Firearms** 77
- Advice for high-velocity arms—Experimenting or changing actions—Fourteen safety rules—Obsolete arms—Makeshift firing pins—Fitting blocks to single-shot actions—Writing to powder companies for correct powder charges—Review of exploded arms—Safety in the use of muzzle-loading rifles—Oil and gun grease in the barrel and chamber—Obstructions in barrels—Shooting out obstructions—Head space—Threading barrels to actions.
- VII — Selection of Woods** 83
- Species of walnut: English walnut, American black walnut—The reason for high prices of select wood—Seasoning the blanks—Selecting the stock blank—Selection of native woods—Weights of woods—Almond wood, Amboyan wood, apple, blackbean, blackwood, beech, birch, cherry, wild cherry, cocobola, curly ash, ebony, holly, mahogany, maple, myrtle, Queensland honeysuckle and African stinkwood, Osage orange, paduka, persimmon, plum, rosewood, satine—Walnut: European, African, American black walnut—Circassian walnut, East Indian walnut, English walnut, Italian walnut, Spanish walnut, Turkish walnut, yew wood—Securing wood in the log and freshly felled trees—Natural vs. artificial seasoning—Seasoning board and quarter-sawed planks—Planting walnut trees—Checkering of opened and closed grain woods—Use of templets in cutting blanks—Prices of blanks.
- VIII — Designing the Gun Stock** 101
- Evolution of firearms—Problem of fit—Drop and recoil—Instructive arm pitch in stock design—Balance or center of gravity of an arm—Difference between metal and wood working—Forearm design—Close grips—Methods of estimating length of stocks—Target stock—Stock nomenclature—Stock design for women—Pitch—Cast-off, cast-on—Butt-stock design—Cheek piece—Comb design—Forearm design—Design of sides—Grip, hand and pistol—Single-shot action stocks—Shotgun stock design—Abnormally formed stocks—The trigger.
- IX — Laying Out the Stock — Inletting the Action** 123
- Selecting the blank—The popular rifle—Inletting an action—Placing the magazine—Dimensions of a guard—Allowance for clearance—Laying out for the receiver—Use of lampblack—Position of projection—Pointed screws—Laying out holes—Use of centering device—Guard bushing—Use of mallet for impression—Chisels used in fitting—Use of templets—Inletting of a Krag receiver and trigger guard—Inletting a shotgun action—Removal of the mechanism—Use of the butt clamp—Cut-outs for the trigger guard—Inletting a Fox action—Inletting a side-lock shotgun—Fitting the forearm—Selection of wood—The first cuts to make—Inletting Lebel and Russian action—The Mannlicher Schœnauer, the Model 1917 Lee Enfield, Newton, Ross and Savage—Bolt-action rifles: Springfield and Mauser—Stocks held to action by bolts: methods of fitting—Automatic rifles and shotgun inletting—Fitting stock bolts—Re-

lief at recoil shoulders—Use of glue in fitting—Forearm tips of buffalo horn, ivory, etc.; fitting of same—Defects in woods, what to avoid.

X — Modeling and Shaping the Stock 143

Modeling and final shaping—Sight gauges for drop—First lay-out lines—Fitting the butt plate—Attaching the sights, sighting in the rifle for zero—Rubber recoil pad—Buffalo-horn butt plates—Trap butt plates—Plain shotgun stock—Repairs when a bit comes out at the side—The inlay—Roughing out—Position of stock in the vise—Use of the gun brace—Use of the plane, draw-knife and spoke-shave—The stock taking form—Undercuts for comb—Forming of cheek piece—Fitting of pistol-grip cap—Remedy for small imperfections—Buffalo-horn tip—Shotgun stocks—Monte Carlo effect—Side panels—Side-plate fitting—Finishing of stocks with sandpaper—Placing the stock in the checkering frame for sanding—Raising the grain—Sandpaper holder—Working curly maple with sanding drums—Making round forearms for Winchester and Remington type of forearms.

XI — Bedding Barrels and Actions 159

Colonel Whelen's standard stock design—Bedding in the metal portions of the rifle—Light rifles and accuracy—Bedding as the deciding factor of accuracy—Methods used at the Springfield Armory—Wood surrounding tang of receiver and trigger guard—Flat under-surfaces of receiver—Bearing in the wood—Full stocked forearm.

XII — Giving the Stock Its Final Finish 165

Experimental stages of the finish—Chemicals used in staining woods—Oil finishes—Importance of using wood filler—Use of rottenstone—Rubbing pad—Use of muslin wheel—Paste used for polishing buffalo horn—Luster on a stock—Formula No. 1 for finishing, Formula No. 2, Formula No. 4—The mixing of formulas—Formula No. 5, Formula No. 6, Formula No. 7—French polish—The rubbing pad—The spiriting-off process—Violin varnish finish—Stains and their uses—Acids—Formulas Nos. 8 and 9: stain for maple—Formula No. 10: stains for cherry—Lacquer finish—Removal of varnish—Buffing-wheel polish—Time required to complete an oil finish—Finishing a gun stock.

XIII — Checkering, Carving and Inlays 179

Patience and concentration necessary to learn checkering—Checkering old stocks—Designs for pistol grip—Pattern laid out with lead pencil—Laying-out scale—Music wire and pins for forming master lines—Practise—The checkering cradle—Use of checkering tools—Instruction for beginning checkering—Guiding the tools—Checkering on forearms—Use of the bent needle file for finishing checkering at the pistol grip—Border designs—Instruction for placing borders—Matting and beading tools for borders—Designs—Checkering butt plate and pistol-grip cap—Matted surface in place of checkering—Carving—Carver's tools and oilstones—Inlays, shields and ovals—Inlays of fancy woods.

XIV — Stock Surgery 201

Shaping the Springfield sporting stock—First steps in remodeling—The two reinforcing bolts—Fitting new butt plates—Raising the comb on service stocks—Attaching combs and pistol grips—Gluing inlays and insertions—The use of dowels—Marking off the drop and other lay-out lines—Working over the forearm—Mistakes of the amateur—The glued-on cheek piece—The inserted cheek piece—Refinishing ideas on patches and inserts—Removal of pistol grip on a shotgun—Reshaping forearms—Repairing broken stocks—Removal of dents—Use of gunmaker's shellac—Use of plastic wood.

XV — Laminated Woods for Gun Stocks	213
Gluing pieces of woods together—Experimental samples—Strength in laminated pieces of woods—The warp of all woods—Structure of wood—Selection of stock blanks—End checkering—Coating the ends of blanks.	
XVI — Modernizing Military Small Arms	219
Preference for bolt-action arms—Becoming a member of the National Rifle Association—How to remodel a military arm—Sight arrangements—Offhand shooting—Trigger pulls—The number of military arms to work on—Leaf-sight arrangement—The aperture sight fitted—Work on the Russian—Remodeling the Model 1917 or Enfield rifle—Converting the Mauser military model, the Ross, the Japanese Arisake Model 1905, the Lee Enfield caliber .303, the Model 1873 Springfield caliber .45-70—Making a muzzle-loading arm from the Model 1873 Springfield.	
XVII — Fitting of Sighting Equipment	231
The telescope sight—Open sights—Aperture sights—Front sights—Factory sights—Firing the rifle to aline sights—The tang aperture sight—Sight arrangements on military arms—Selection of front sights—The aperture sight applied—Aperture sight extensions—Fitting sight bases—Table of tap sizes—Set-up for drilling bases—Drilling and tapping—Drilling hardened actions—Alinement of sights—Mounting cocking piece—Barrel sight bases—Front sight ramps—Telescope bases—Fitting telescope, side and top mounts—The hunting telescope—Reaming aperture discs—Fitting Lyman 48 sight.	
XVIII — Replacement of Small Working Parts	255
The cause of friction—Determining tolerance—Finish on working parts—Patience and care in fitting—Lubricated surface—The lapping operation in fitting—Fitting the hinge bolt.	
XIX — Hand-forging and Heat-treatment	261
Blacksmith's equipment—The forge—Air pressure—Fuels for the forge—Welding heat—Fluxes for welding—Hardening and tempering—Tempering knife blades—Tempering firing pins and extractors—Quenching baths—Oil heating baths—The potassium nitrate bath—The lead bath—To restore burnt steel—To anneal steel—To blue steel—To remove the blue color—Test for good steels—Case-hardening—Methods used in earlier times.	
XX — Revolver and Pistol Repairs	271
Credit given manufacturers of hand guns—Pistol grips—Materials used to make grips—Sights—Sight adjustments—Changing and fitting barrels—Replacement of parts—Misfires—Checkering metal parts—Changing hammers—Loose screws—Altering revolvers—Reaming barrels for the use of shot—Relining revolver barrels—Single-shot pistols—General hints.	
XXI — Problems of the Trigger Pull	293
The hard trigger pull—The plain trigger—The required trigger pull—The stoning operation—The target revolver—Study of mechanism by removing side plates—Automatic pistols—Bolt-action trigger pulls—Take-up, etc.—Set triggers—Shotgun triggers—Use of snap caps—Sear—Troubles of shotgun and single triggers—Speeding up lock time—Problem of lock time and trigger pulls.	
XXII — Amateur Etching and Engraving	307
Copying objects on tracing paper—Tools for etching—Scrapers—Burnishers—Acids or mordants—Labeling bottles—Trays—Ammonia—Stopping-out varnishes—Matting tools—Border tools—Damaskeening—Engraved receivers.	

- XV — Laminated Woods for Gun Stocks**..... 213
 Gluing pieces of woods together—Experimental samples—Strength in laminated pieces of woods—The warp of all woods—Structure of wood—Selection of stock blanks—End checkering—Coating the ends of blanks.
- XVI — Modernizing Military Small Arms**..... 219
 Preference for bolt-action arms—Becoming a member of the National Rifle Association—How to remodel a military arm—Sight arrangements—Offhand shooting—Trigger pulls—The number of military arms to work on—Leaf-sight arrangement—The aperture sight fitted—Work on the Russian—Remodeling the Model 1917 or Enfield rifle—Converting the Mauser military model, the Ross, the Japanese Arisake Model 1905, the Lee Enfield caliber .303, the Model 1873 Springfield caliber .45-70—Making a muzzle-loading arm from the Model 1873 Springfield.
- XVII — Fitting of Sighting Equipment**..... 231
 The telescope sight—Open sights—Aperture sights—Front sights—Factory sights—Firing the rifle to aline sights—The tang aperture sight—Sight arrangements on military arms—Selection of front sights—The aperture sight applied—Aperture sight extensions—Fitting sight bases—Table of tap sizes—Set-up for drilling bases—Drilling and tapping—Drilling hardened actions—Alinement of sights—Mounting cocking piece—Barrel sight bases—Front sight ramps—Telescope bases—Fitting telescope, side and top mounts—The hunting telescope—Reaming aperture discs—Fitting Lyman 48 sight.
- XVIII — Replacement of Small Working Parts**..... 255
 The cause of friction—Determining tolerance—Finish on working parts—Patience and care in fitting—Lubricated surface—The lapping operation in fitting—Fitting the hinge bolt.
- XIX — Hand-forging and Heat-treatment**..... 261
 Blacksmith's equipment—The forge—Air pressure—Fuels for the forge—Welding heat—Fluxes for welding—Hardening and tempering—Tempering knife blades—Tempering firing pins and extractors—Quenching baths—Oil heating baths—The potassium nitrate bath—The lead bath—To restore burnt steel—To anneal steel—To blue steel—To remove the blue color—Test for good steels—Case-hardening—Methods used in earlier times.
- XX — Revolver and Pistol Repairs**..... 271
 Credit given manufacturers of hand guns—Pistol grips—Materials used to make grips—Sights—Sight adjustments—Changing and fitting barrels—Replacement of parts—Misfires—Checkering metal parts—Changing hammers—Loose screws—Altering revolvers—Reaming barrels for the use of shot—Relining revolver barrels—Single-shot pistols—General hints.
- XXI — Problems of the Trigger Pull**..... 293
 The hard trigger pull—The plain trigger—The required trigger pull—The stoning operation—The target revolver—Study of mechanism by removing side plates—Automatic pistols—Bolt-action trigger pulls—Take-up, etc.—Set triggers—Shotgun triggers—Use of snap caps—Sear—Troubles of shotgun and single triggers—Speeding up lock time—Problem of lock time and trigger pulls.
- XXII — Amateur Etching and Engraving**..... 307
 Copying objects on tracing paper—Tools for etching—Scrapers—Burnishers—Acids or mordants—Labeling bottles—Trays—Ammonia—Stopping-out varnishes—Matting tools—Border tools—Damaskeening—Engraved receivers.

CHAPTER	PAGE
XXIII — Stripping Actions, Oiling and Minor Repairs	323
Bolt-action rifles—Polishing parts—Stoning parts—To dismount the bolt—To assemble the bolt—The shotgun—Oiling arms—Handling parts—Assembling and disassembling single triggers—Use of the spring vise.	
XXIV — Minor Repairs and Adjustments	333
The use of a gun—Skilfully removing a worn muzzle—Lapping a muzzle—Poor ignition—Alteration on single-shot actions—Alteration on Martini action—Springfield bolt stop, screw positions—Attaching temporary sights for sighting in.	
XXV — Miscellaneous Formulas and Methods	341
Gunmaker's shellac—Gun oil—Means of water-proofing outdoor garments—Miscellaneous lubricants—Fixed oils and fats—Brown or thickened oil—Rosin oil—Soap and grease lubricants—Adulterants—Testing oils—Powder solvent—Metal-fouling solution—Mercury—Sulfur casts—Patterns—Glue for patterns—Shrinkage draft for patterns—Allowance for finish—Glue—Gunmaker's glue—Shellac varnish—Steaming woods for bending—Loose wood screws—Testing iron and steel—Home-made drill press—Where colors come from—Useful information.	
XXVI — Soldering, Brazing and Welding	355
Soldering—The fluxes—Soldering liquids—Soft solders—Hard soldering and brazing sweating—Fluxes for soldering—Alloys for brazing solders—Silver solder—Autogenous welding—Directions in the use of a welding outfit—Oxy-acetylene torch—Adjusting the torch: size tips to use—Preheating welding steel—Welding brass—Cutting metals with oxidizing flame—Operating the cutting torch—High and low pressure torches.	
XXVII — Field Repair Kits and Devices	367
Planning the repair kit—Repairs to broken stocks—Action or top-lever breaks—Dents in shotgun barrels—Repairs to bolt-action rifles—Sights—Obstructions in barrels.	
XXVIII — Experimental Factors Governing Small-arms Ammunition	375
The cartridge case—Primer pockets—Automatic arms—The rifle and accuracy—Factors in rifle shooting—Standard telescope sight—Factory layout—Bullet experimental factors—Designs of the future.	
XXIX — Mechanical Definitions and Phrases	411
Glossary compiled to assist in the understanding of shop terms used by gunmakers, past and present.	
Directory	419
Index — See end of Volume II.	

ILLUSTRATIONS — Volume I

FIGURE	PAGE
The attic workshop, where one spends many leisure hours	<i>Frontispiece</i>
1. Tool maker's angle plate	10
2. Wood bit for brace—intended for wood only	11
3. Checkering tool designs	12
4. Milling cutters for making checkering tools	12
5. Wood gouges—easily made from drill rod	13
6. Fluted countersink	14
7. Half countersink	14
8. Drill set in number sizes	15
9. Drill set in fractional sizes	15
10. Drill gauges in number and fractional sizes	15
11. Avery tool-room drill press	16
12. Barrel-muzzle reamer	18
13. Magnifying glass and holder	18
14. Shapes of oilstones	19
15. Dowel-pin plate	19
16. Taper-pin reamers, straight and spiral fluted	21
17. Machine reamer	21
18. Expanding reamer	21
19. Counterbore	22
20. Straight-edge for checking pitch of rifles and shotguns	22
21. Types of screw-drivers used in gun work	23
22. Bench-vise blocks commonly used in the gun shop	26
23. Bench or stand for checkering cradle	29
24. Checkering cradle for the amateur's construction	30
25. Improved checkering cradle for the amateur	31
26. Checkering cradle most generally used in the gun shop	32
27. A portable bench grinder is indispensable	32
28. Bottoming tools	34
29. Bench gun brace and scoring tool	35
30. Rifle holder for testing purposes	36
31. Home-made tool holder for bench grinder	37
32. Correctly ground lips	52
33. Special grinding for hard metal or brass	53
34. Glass drill	53
35. An indication of too great speed	53
36. (a) Thinning the web of a drill. (b) Showing where the emery wheel has removed the metal	54
37. Correct lip clearance	54
38. Incorrectly ground lips	54
39. Another case of incorrectly ground lips	55
40. The correctly ground drill	55
41. A rough, inaccurate hole—result of a dull drill	55
42. Internal lap, arbors, and driving pin	58
43. External lap holder	58
44. Cast-iron lapping plate	59
45. Bench burners and equipment for tempering small parts	64
46. Illustrating different views of an object in mechanical engineering	70
47. A Springfield rifle that blew up	77
48. Shotgun stock blanks, furnished by Mitchell Bosley	84
49. Rifle stock blanks, furnished by Mitchell Bosley	85
50. Caliber 6.5 mm. Steyr action, made by Rigby	86
51. Light caliber 30-06 Springfield designed by Dr. George Quay	87
52. William Ford 20-gauge double	88
53. Savage caliber 25-3000 bolt-action rifle, restocked with bird's-eye maple	89
54. Restocked Krag rifle	90

FIGURE	PAGE
55. Model 1898 Springfield remodeled.....	90
56. Model 1903 Springfield rifle, remodeled into sporting type.....	91
57. Caliber .22 made on a Martini action.....	92
58. Francotte 12-gauge double shotgun.....	92
59. A Charles Daley three-barreled gun.....	93
60. Joseph Lang 12-gauge trap gun restocked with fine Italian walnut.....	94
61. Stock patterns, or templets, cut from ¼-inch wood.....	96
62. Francotte 12-gauge trap gun stocked for the shooter's holding comfort.....	102
63. Restocked caliber 30-06 Newton rifle designed for persons who have lost the use of certain fingers.....	103
64. Target stock design used with aperture sights.....	104
65. Caliber .22 match rifle, single-shot Winchester action.....	105
66. Layout for sporting rifle stocks.....	107
67. Layout details for average shotgun stock measurements.....	108
68. Butt plate and pistol-grip templets.....	109
69. End view of a Monte Carlo stock, and special cheek piece.....	110
70. Under side of a well formed and graceful cheek piece.....	110
71. Forearm designs for rifles and shotguns.....	112
72. Rifle and shotgun stock designs.....	114
73. Offset rib used for monocular vision.....	118
74. Springfield receiver with locating screws in position.....	123
75. How a Springfield receiver is ground at tang for more graceful outlines when restocking.....	124
76. Springfield guard templet for laying-out purposes.....	125
77. Sporting stock layouts for Springfield Model 1903 rifle.....	127
78. Centering device used on drill press to aline screw holes when fitting actions into stocks.....	128
79. Bench work. Fitting stock to an action.....	137
80. Suggestions for the application of forearm tips to sporting arms.....	139
81. Brace countersink.....	146
82. Types of butt plates used on rifles and shotguns.....	148
83. Sanding drum for use on bench grinder.....	155
84. Whelen design of cheek-piece and stock measurements.....	159
85. Rubbing pad for polishing a finished stock.....	167
86. Beautiful example of the gun maker's art—by V. Chr. Schilling.....	175
87. Simple checkering designs.....	180
88. Pistol-grip designs.....	181
89. Forearm checkering designs.....	182
90. Laying out a checkering design.....	183
91. Forearm checkering designs for single-shot rifles.....	185
92. Design suggestions for carving or checkering stocks.....	187
93. Beading punch for border designs, etc.....	188
94. Julia Thornely checkering the pistol grip of a finished stock.....	189
95. Design suggestions for checkering butt plates and pistol-grip caps.....	191
96. Design suggestions for carving gun stocks.....	193
97. Caliber-.22 "Hornet" rifle made by Westley Richards.....	194
98. Typical methods of cutting out patches for insertions in wood.....	195
99. Design suggestions for inlays in gun stocks.....	196
100. Layout for inlay insertions in military service stocks.....	202
101. Model 1896 Krag rifle worked over by Dr. M. D. Stepp.....	205
102. The applied cheek piece.....	206
103. Insertion of cheek piece.....	206
104. Parker 12-gauge shotgun.....	207
105. Lamination of wood for gun stocks.....	214
106. Correct way to saw gun-stock planks from log.....	215
107. Incorrect way to saw gun-stock planks from log.....	216
108. Caliber 350-2 Rigby double-barreled rifle.....	219
109. An amateur's gun shop. Dr. E. J. Witzel in a corner of his basement.....	223
110. An amateur's first attempt at remodeling a military rifle.....	224
111. Muzzle-loading shotgun, 20 gauge, made from a caliber-45 Model 1873 Springfield.....	226
112. The famous Lyman 48 aperture sight for Winchester Model 54 rifles.....	232
113. Lyman globe target front sight showing the nine interchangeable insertions.....	223
114. The Lyman 48 sight adapted to the Model 19 and 23 Savage rifles.....	223
115. Lyman 103 micrometer tang sight. Click adjustments for windage and elevation.....	235

FIGURE	PAGE
116. Illustrating how leaf-sight bases are applied to sporting arms.....	238
117. Special extensions for aperture sights.....	239
118. Lyman 103 sight mounted on the end of a Springfield .30-03 bolt sleeve.....	242
119. Drilling jig for placing telescope blocks on rifle barrels.....	245
120. Rifle bore sighting instrument.....	249
121. Springfield Model 1903 rifle designed for Mr. Charles G. King.....	250
122. Remodeled Springfield rifle, Model 1903, with complete sight equipment.....	251
123. Hand fitting operation on small parts as performed in the large arms plants.....	256
124. Preparation of metal for welding purposes.....	263
125. The old peace-maker that brought law and order to our early frontier. The Colt single-action revolver.....	272
126. Plates and finger grip used on target revolvers for better holding.....	274
127. Tools for removing and screwing in revolver barrels.....	277
128. Colt caliber .22 automatic. A very efficient weapon for the woodsman.....	280
129. Springfield striker or firing pin.....	280
130. Caliber .22 Hornet made on a Remington caliber .50 revolver action.....	286
131. Firing mechanism of Springfield Model 1903 rifle.....	297
132. Set-trigger mechanism as used in the German Mauser sporting rifles.....	299
133. Beautiful examples of the steel engraver's art.....	308
134. Relief engraving showing cloud effect in background.....	309
135. Essential tools and equipment for the amateur: suggested scroll designs.....	311
136. Leaf effect, to be etched in steel.....	312
137. Ballard action engraved in high relief.....	314
138. Ornamental screw heads.....	315
139. Matting tools. Damaskeen lap for frosted effect on steel or other metals.....	315
140. Fine examples of etching or engraving to work from.....	317
141. Shotgun action engraved in high relief.....	319
142. Firing-pin impressions left on caliber .22 cartridge cases.....	334
143. Primer flashes showing how propellant is ignited.....	335
144. Types of firing pins.....	336
145. Eccentric lever pin—Pope design.....	336
146. Home-made steam box.....	349
147. Home-made drill press.....	350
148. Fixture for brazing ramps, sight bases, swivel bases, etc.....	359
148a. Field vise. A very effective means of holding parts in an emergency.....	370
149. View of a caliber .30 boat-tailed bullet in flight.....	376
150. Rim-cartridge case.....	377
151. Rimless cartridge case.....	377
152. Semi-rimless—a questionable design.....	377
153. Belted cartridge case.....	377
154. Chamber pressures of lubricated and dry ammunition.....	379
155. Cartridge-loading machine.....	387
156. Double-action press, capable of producing 20,000 cartridge cups per hour.....	388
157. First and second operation draw press, friction dial feed, for rifle cartridge cases.....	388
158. Hopper-feed cartridge-case draw press.....	389
159. Cartridge-case pocketing and heading machine.....	390
160. Cartridge-case vent-punching and pocket-resizing machine.....	390
161. Cartridge-case head-turning machine.....	391
162. Cartridge-case annealing machine.....	391
163. Cartridge-case tapering machine.....	392
164. Machine for gauging and weighing the assembled cartridge.....	393
165. Double-action press, used to form the cup, the start of a bullet jacket.....	395
166. Caliber .30 flat-base bullet in flight.....	396
167. Caliber .375 and .404 bullets.....	397
168. Bullet-jacket draw press, for second, third, and fourth redraws.....	398
169. Automatic-feed, bullet-jacket trimming machine.....	401
170. Slug-forming machine, employed to form the lead cores in jacketed bullets.....	403
171. Bullet-assembling press.....	405

INTRODUCTION
Purely for the
Amateur

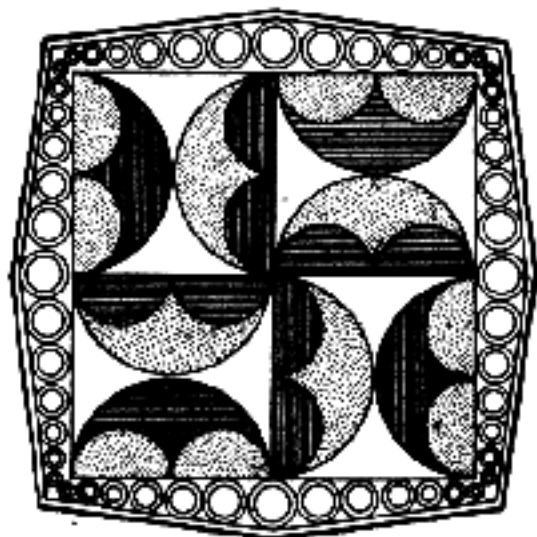

The Modern Gunsmith

INTRODUCTION

Purely for the Amateur

MY OBJECT in writing this book is to bring the enthralling business of gunsmithing into the life and down to the abilities of the every-day gun lover who has a mechanical mind and an aptitude in the use of tools. I hope to lead him step by step to attainments worthy of a professional mechanic, and eventually to a place where he will be able to do all the things necessary in the production of a complete arm. With this in view, I shall devote this introduction purely to the amateur who knows little about gun making, but who has the desire and the ambition to learn and to achieve. I believe that the best place to make a start is in renovation. Tearing down an old gun, removing the rust and dirt of years, and replacing each part, gives one a direct knowledge of its components, their uses and functions, that a study of drawings can never impart.

Spending leisure time on an old muzzle-loading rifle of the early period gives a start in creative work, and when carried out scientifically is profitable in many ways, keeping both mind and body active. The instinct to create is resistless; as children, with unskilled fingers, we patiently try to build with toys the concepts of our fertile imaginations; still with determination we continue, even tho failure is repeated many times. As men, most of us still have that instinct to build, tho many lose it in later years through lack of the right environment. We have learned that direct teaching in childhood furnishes the best foundation for our hobbies in later life; exclusive of bridge and golf—two national pastimes frowned upon by those with creative ability—such instruction is too often lacking in thoroughness.

How strange to be born without the desire to direct one's hands by the mind to create an object or bring a worn article back to its original condition! Renovation, as a start; beginning with an old piece of furniture, if no better object can be found. Do not harbor the impression that a hobby must be creative, or inventive, or must be a benefit to home, office, or mankind. Most of us are just poor weak creatures, improving on the ideas of va-

rious other individuals. From a humble start something materializes—tho it may benefit only yourself—by giving peace of mind and body.

Living in large cities, in apartment houses, and having rapid, easy transportation, as well as stores that sell or procure for the customer everything from toothpicks to ready-made cottages, the modern youth has entered a state of decadence that his forefathers would have looked upon with outspoken condemnation. The object of one's desires is handed to him without the slightest effort on his part—complete, and even delivered. Wants that sixty years ago would have meant labor and self-denial, are now supplied without turning one's hand; and the result is a regrettable decline in knowledge of the simplest tools. This may mean more to the human race than one would care to acknowledge, for the best definition of man is that he is "the tool-using animal." In the large cities today it is very rare to encounter a person who can use the simple hand tools. Where this loss of skill finds its saddest expression is in the management of our hobbies. The one thing in life with an appeal strong enough to lend encouragement in the battle of existence is missing; unoccupied time becomes poisonous and injurious to home and happiness. Hobbies have saved many men by keeping them sane. If you do not already have one, find one for yourself and ride it—whether it be firearms or something quite different. Many may not be capable of even thinking up an adventure and pursuing it in their present environment; but there is a wide range to choose from—collecting minerals, jewelry, pipes, books, old money, antiques, stamps, china, glass, etchings, art, etc. This list could be lengthened and still one could find some other thing that would serve to keep him sane. If nothing else appeals to your taste, why not become a collector of arms with historical interest for the den decorations?

Lack of mechanical knowledge, in most cases, is due to not being willing to learn. The familiar excuse, "I'm too old to take up a hobby," can no longer be accepted. Be what you may; a trial

directed seriously along mechanical lines will reveal that you are not nearly so helpless as you supposed. Many a man—and woman, too—has an unsuspected aptitude for tools. An old muzzle-loading rifle may look hopeless to the layman, but to the lover of tools it offers the possibility of spending many hours of enjoyable labor in its renovation.

In the eastern part of the United States one can often find these old arms in unexpected places. They lurk in old attics and can be purchased on very reasonable terms, considering their value from the viewpoint of the collector. Many can be secured in antique shops, while others can be purchased from individuals in whose families they have been for many years; handed down from generation to generation. Often interesting history will accompany the weapon. Securing one is in itself enough to inspire you to lay plans for its complete renovation. The older the arm the more the barrel is rusted and worn. Parts have been made by the former owners or by local gunsmiths. The stock may be broken or rotten in places; broken stocks often require the making of new ones, but in any case the repairs to the old ones are likely to tax one's ingenuity. New pieces of wood can often be set in, matching the old wood so well that it is hard to detect where the repairs were made. All the metal parts and brass furniture will need polishing. (The term "furniture" is used for the trigger guard, patch box, butt plate, etc.) The wood screws will need to be renewed; likewise the keeper pins, and iron screws.

As all guns are merely mechanisms for exploding a charge and directing a bullet, you will be surprised how constant these functions are and how little change has taken place in centuries. The names, even of the important parts of gun mechanisms, have persisted from the days of the flint-lock to our own times. So if you, Mr. Beginner, have carefully noted the function and uses of all the parts you have dissected in Grandad's old squirrel-gun, you have gone a long way into the science of gunmaking and will recognize the similarity, even in the differences, when you examine the vitals of the modern breech-loader.

If Grandad's old gun is available, let us start on that. Almost surely it will not be quite complete; some parts will be missing or worn. Let us see what you can do. First, strip it down by removing the barrel from the stock. You will find that it is secured at two places: a cross-bolt transversely through the fore-end and either a hook engaging in the false breech, or as is more common, a screw running downward through the tail or tang of the breech-plug into the stock. Place the barrel in

a vise, using clamps of lead, copper, or felt-lined jaws to prevent marring the barrel by the hardened jaws of the vise, and with a large wrench, unscrew the breech plug. You may have to soak the barrel end in kerosene before you can move the plug, and in some cases heat will have to be applied by means of a gasoline blow-torch. With the plug removed, you will have complete access to the bore, and will be able to see its condition and to go intelligently about its scoring. With the barrel work completed, you will remove the lock and "furniture" by unscrewing the side plate, and this will have your next attention. If you decide to dismount the lock, you will have to devise a little gadget to compress and hold the mainspring in tension in removing and replacing it. Only the furniture will not be attached to the stock.

Perhaps you have a 25-20 single-shot Winchester rifle having a worn muzzle, poor sights, a trigger pull that needs stoning, an action that needs polishing, and a stock and forearm that are not just right. If you have not discovered these defects beforehand, you will in actual shooting on the range, where they will be revealed in the target you produce.

Let us suppose that the groups are all in a twelve-inch circle at one hundred yards. You know that you can hold a little better than this, so the first trouble you will look for is a badly worn muzzle. If this should be the case, cut off from one-half to one inch with a hack-saw and file the muzzle square, using a small try-square having a thin knife-edge blade. File so that you cannot see any light under the blade, or as close as possible to square, by checking from all four points on the end of barrel. With a 60-degree counter-sink, just break the edges of the rifling. When this is finished, proceed to lap the barrel as described in Chapter XVIII, Volume II.

If the rifle is not equipped with a marine-type front sight, make one the same height as the old sight, but about .09 inch wide. Now take it out to the range again and fire for groups. You will be surprised to see how the groups have been reduced, for nine times out of ten this operation will bring new life back into even some of the old muzzle-loaders that look from the muzzle as tho they had a hexagon bore.

After you have breathed this new life into the rifle, so to speak, you will find that you have released a hidden spring in yourself. You will realize that if it only took a hack-saw, a file, and a lapping rod to improve an old, neglected barrel, then raising the comb or making a new forearm will do infinitely more. Place the sling swivels in a better position and you begin to find that results are

obtained of which you never dreamed you were capable.

It will be well to overcome the desire to create the work of an artist and be content to face the problems of apprenticeship. Start by practising on the mortising of a piece of metal into a piece of wood. It does not matter what you pick up in the form of a metal piece, but try to fit it in so that there will be no openings around the metal. If you are successful, try anything that has an odd shape or form and work that until you become so accustomed to using the tools that you have complete confidence in yourself. Square pieces of wood with a plane and use the checkering tools on sample pieces of walnut.

Wood work, I think, requires an almost innate skill, especially in the building of a stock. Study the methods not only of men familiar with the particular problems of gun work, but also those of cabinet makers, pattern makers, and musical-instrument makers, for you can learn some things from all of these trades. Naturally, wood work is easier for most of us than metal work, for wood work requires artistic ability, instinct, and forethought, while metal work requires a sound knowledge of its own particular science.

At first, file out your checkering tools from umbrella staves. Bend the staves and file fine teeth in them, just as in a checkering tool (one of these is only a double saw), and this will give you an idea of keeping lines straight. Make up a matting tool also, to see the type of design it will produce on wood. Just take a piece of $\frac{3}{16}$, $\frac{1}{4}$, or $\frac{9}{32}$ square steel, and cut it off three or four inches in length. File fine teeth or points on the end with a small needle-slitting file. It will not be necessary to harden this temporary tool. Try it on a piece of wood by tapping it lightly with a small hammer to see the effects brought out on the wood.

As I look back upon my own start, I remember well the experiences I had. I bought no tools except a small vise for which I paid two dollars. The bench was constructed of light boards, and had a rocking-chair motion when I tried to do any work on it. My wood chisels were made from $\frac{1}{8}$ " x $\frac{5}{16}$ " drill rod. These were as bad as the bench and the vise; yet I fitted a Springfield action into a walnut blank with them. With a rasp and a bastard file, I shaped up the outside, sanded the stock, oiled it, and checkered it with a checkering tool made from the same drill rod.

After my first experience, I realized my requirements, and began to spend some money for equipment—a substantial bench, a good swivel vise, chisels, brace and bits, planes, good screw-drivers, files and rasps, spoke-shaves—and made up special

tools that I discovered were needed and unobtainable. From then on things were better organized, but as I recall those days, I cannot help wishing that I had been able to turn to the pages of a book such as this.

We all make a good many mistakes in the beginning. Even today I make some that cost me a lot of time and money to repair. Do not try to rush your work, for in gunmaking this cannot be done. Gunsmithing, while it is a trade in itself, is really made up of a number of specialized branches, such as tool making, die making, cabinet making, and instrument making. You must specialize in all of these, but in changing from one to another, mistakes will creep in now and then.

Before taking a firearm apart, study its construction, and through simple reasoning, figure out why the manufacturer made it in that particular way. There is a reason for every screw placed in a mechanical device. Many automatic pistols come to my shop after they have been taken apart, and occasionally when I receive such arms they are beyond all hope of repair. When the beginner is in doubt, he should consult someone who knows, for it does not pay to blunder ahead without thinking what the various parts are for. But once you have gained a good understanding of the principles of the firearms of different makes, you soon develop an almost instinctive knowledge of all the mechanical arrangements of the actions and will not hesitate to dismantle any firearm for the first time. Remember each and every part you remove, and put it down in a consecutive position on the work bench, so that the mechanism may be put together as it came apart.

One of the most important things in this field is a clear understanding of firearms and the reloading of ammunitions, not only of the firearms you own, but of others as well. Read the books dealing with these problems from the pens of such authors as Whelen, Crossman, Mattern, Greener, etc.; and also reference guides such as the machinery handbooks and texts by Fred H. Corbin and Frank A. Stanley. Such books as these deal with shop practise and the general principles of mechanics. It will be well to start a library not only of books, but catalogs as well, for these contain a wonderful amount of valuable information. Write for those on the list which the Directory contains, and you will find that they offer a course of study which in time becomes indispensable. The tool catalog is especially valuable, for there you will find tools that answer for other purposes than gun work. Nearly all the large hardware houses circulate catalogs, but it is doubtful if they would forward one of these to an individual without any business con-

nection. So, for the average person, it is best to secure both Sears, Roebuck and Montgomery Ward catalogs, as these contain almost all the tools and supplies the beginner will need.

I have spent a number of years in gun and ammunition work and have gained experience, not only from the standpoint of a small gunsmith's shop, but from a number of years spent in one of the U. S. Government's largest arsenals and other fine institutions where it was possible to acquire a world of knowledge in mechanics. I am passing this information to the reader without concealing any trade secrets. Some subjects could be treated

in separate books, but as long as the reader is able to grasp the principles with a clear understanding of the reasons behind various instructions, he will develop his initiative to a point where he can accomplish great progress in the construction and repair of firearms. Finally, be sure your ideas are practical and not theoretical, for you will spend long hours proving these ideas. This is satisfactory providing it does not run into too much expense, for by doing it, ultimately you will have gained experience proving your theories; and when the results do not prove satisfactory, just charge it up to experience.

CHAPTER I

The Workshop, Tools, and General Equipment

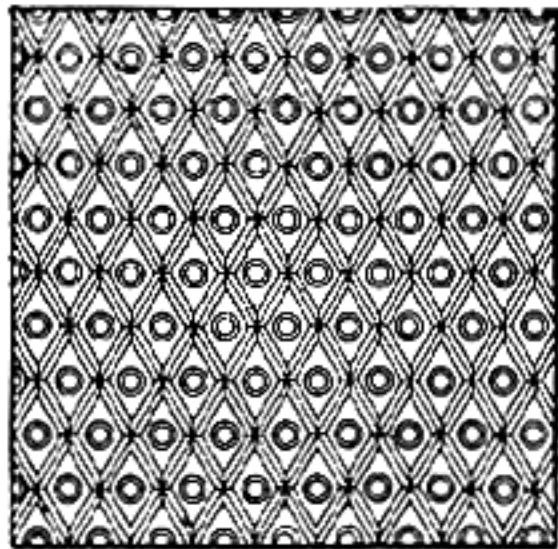

The Workshop, Tools, and General Equipment

INASMUCH as it is essential that the mind be free from trouble and distraction in order to produce one's best work, the workshop should be located in such a place as will allow concentration. A space should be set aside, if possible, that will be in every respect best fitted for this particular type of work. The difficulty of using the average basement as a workshop is the lack of proper, natural light, an essential element in close work. The shop would be far better were it placed in a well-lighted spare room, perhaps in the attic; or, better still, there may be a space in the yard to erect a simple shed or make an addition to the garage. If one is lucky enough to have a suitable out-building, this is easily converted into a convenient shop. The important qualities are that it be heated and ventilated, that the natural light be good, and that it be roomy enough to contain all the necessary tools, fixtures, and supplies.

As your ideas and mistakes are best developed on paper, it will be well to secure a drafting board, and to place it in a corner of your workshop together with a T-square, 45 and 60 degree triangles, a finely graduated rule, and an inexpensive set of drawing instruments. There you can make a record of all your ideas, and in time you will be able to do any work you want to do with this equipment and the mental picture before you.

The Workbench — This can be made in various ways. You can obtain factory-made, pressed-steel bench legs and build up a top of any size, adding elaborate details if you are so inclined. However, I should advise the beginner to test his skill by making his own bench in its entirety. You can get the necessary 4 x 4 yellow-pine studding, such as carpenters use for house framing, for the legs, making each end frame with two uprights and one crosspiece on top, and a lighter one fastened about 10 inches from the floor. A board can be fastened lengthwise between the frames, and this makes a handy rack to store scrap wood or metal parts. The crosspieces can be fitted into the uprights so that they make a neat joint and can be held together with $\frac{3}{8}$ -inch carriage bolts.

For the top, either get a two-inch plank of yellow pine or some hardwood such as beech or maple.

If you wish to go into the construction more elaborately you can make your top of 1-inch yellow pine, and cover it with maple flooring laid crosswise. This makes a very good hardwood top and will last forever. Yellow pine, altho cheaper, soaks up oil and is never as satisfactory as harder woods. The suitable size for a bench is between 34 and 36 inches in height from the floor to the top of the bench, according to one's stature, and about 24 inches in width. Rubber placed under each leg will greatly soften noise. Drawers should be built and partitioned and attached to the under side of the top. These will hold the tools and files that are not generally in use. A suitable rack at the back should also be built to hold other necessary tools, such as chisels, bits, etc.

The length of the bench can be governed by the available space, but by all means make it long enough, for you will find that much more space is necessary for all your work than you realized. In fact, if the reader has intentions of larger development, it would be best to build two benches, one for his wood work, and one for his metal work, as these two types of work require different attachments, such as vises, etc.

A good bench is absolutely necessary, and you will find that there is no substitute. The kitchen table is useless, for it is important that everything be solid and fastened securely. I do not recommend the purchase of wood working-benches such as are listed in hardware catalogs, for I would impress upon the beginner's mind the importance of gaining the experience step by step, which is done by making everything possible one's self.

Necessary Tool Layout — Here is a necessary tool layout, given in alphabetical order, with a description of each tool. This is to give one a general idea of his tool requirements. Separate chapters will deal with their use:

Alcohol Lamp—A lamp of this kind can be made easily. A gum mucilage bottle has even been used. A .30 caliber cartridge case can be cut off and a section of this inserted for the tube. An oil can may also be used by cutting off a part of the tapered spout and inserting a wick. The bottom of a cartridge case will serve as a cover. This will

make the most serviceable of lamps. Of course the appearance will not be the best or to the taste of a good mechanic, who has pride in his tools, but it will answer the purpose.

The uses of the alcohol lamp are varied; with it you will be able to heat all small parts for harden-

V-grooves vertically and horizontally and to drill and tap for clamps. Then make suitable clamps for fastening the work by means of these V-grooves. One will find that a plate of this nature plays a large part in the layout of new work and in the necessary set-ups to check measurements. It is

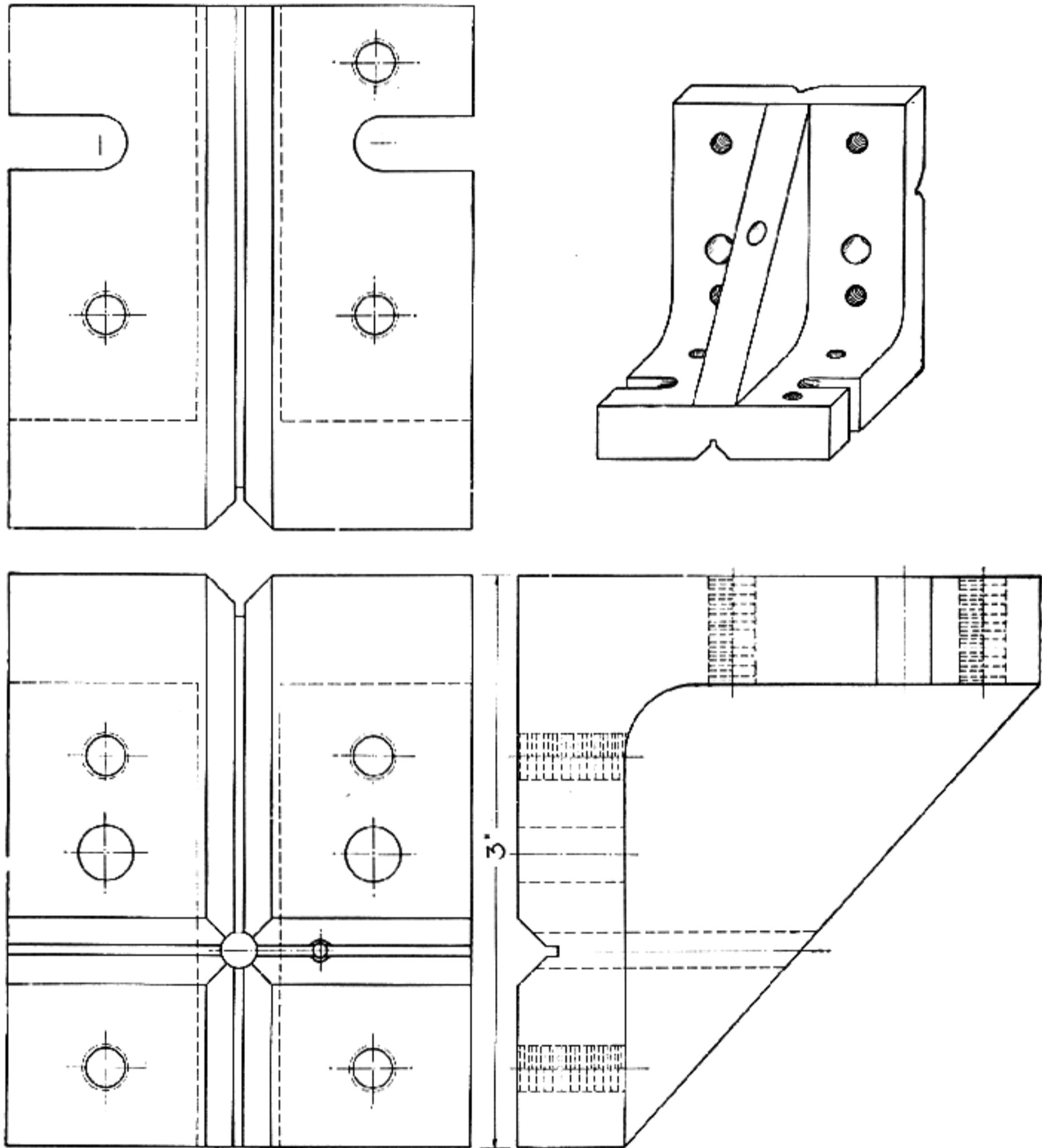

Fig. 1
Tool maker's angle plate

ing and bluing, and it will also serve for drawing the temper of small tools, etc.

Angle Plate—This is a most useful fixture for clamping parts in laying out work. The most convenient size is one 3 inches in height by $2\frac{1}{2}$ inches in width. Angle plates can be purchased from hardware or machinery dealers. The best of plates can be made by an advanced student. Figure 1 illustrates an angle plate. It is best to mill the

also useful for clamping work that must be perfectly square. An angle plate of cast iron is the most satisfactory.

Anvil—An anvil weighing between 40 and 80 pounds is one of the most useful appliances in the heat-treating or blacksmithing department. It will be used to forge springs, to make special hammers, etc. A universal bench anvil will also prove very useful in the shop.

Arbors—When one's equipment includes a lathe, these can be made as required.

Arbor Press—A No. 1½ or No. 2 Greener arbor press can be used for broaching, punching, piercing, straightening, pressing in pins and bushings, re-sizing cartridge cases and bullets, etc.

Bench Stops—These are for the woodworking bench and come in handy for holding work in place while planing. Several of these may be placed in line along the top of the bench, and you will find many uses for them.

Bench Grinders—The best bench grinder is the electrically driven Apex ¼-horse-power grinder, which has ½-inch shafts and takes two grinding wheels. By removing one of the grinding wheels, various disks for cleaning, surfacing, polishing, and countless other operations may be substituted. Hardwood disks, preferably of maple or beech, about 9 inches in diameter and 1 inch thick, are adaptable to a variety of uses. These must run absolutely true to prevent vibration. By gluing sandpaper on the faces of these wheels they can be used for truing the faces of materials such as buffalo horn, ivory, bakelite, and fiber work. It is well to have six or eight of these wheels with sandpaper of different degrees of fineness glued to them. As they wear out, they are easily replaced. With #2 sandpaper attached you can rough down rubber recoil pads, and for finishing you can use a wheel covered with #0 or #00 sandpaper. With the latter you will get a very fine finish free from scratches. On ivory, bakelite, fiber, and similar materials, it is best to experiment with different grades of paper to determine which will produce the best results. This grinder will take the circular wire wheels, felt wheels, muslin, canton flannel, woolen, chamois, buckskin, leather, and sheepskin-covered wheels which will be used in the polishing of steel parts.

Bench or Surface Plate—A plate 14 x 14 x 1½ inches is essential for laying out different things, or for forming up ordinary parts of sheet metal, and when necessary, it is something you can pound on instead of using the bench top. Another plate, of heavy glass, 12 to 16 inches wide and 40 inches long, is a great convenience. This should be placed on a stand that is perfectly level and can be used for a laying-out plate in mounting telescope blocks, for squaring between any filed or machine sections of barrels or action work, for laying out stocks to secure the proper lines of drop and cast-off, and for laying out sight bases and other parts. Such a large surface plate of metal is expensive, but a true glass plate will answer the purposes very well and cost much less.

Bits—Three types of boring bits are necessary in

the general layout: auger, Forstner, and center. The auger bits are not expensive, and it will pay to invest in a high-grade set, graduated between ¼ and 1 inch by sixteenths. Forstner bits are very useful in gun work. Unlike auger bits they have no spur in the center, but are guided by a sharp outer rim or cutting edge which makes a hole with a smooth level bottom. These are the most convenient bits to use for cutting out recesses for locks in shotguns and wherever a flatbottomed hole is required. These bits are often incorrectly referred to as "Foster bits." The center bit is short and is used in gun work only for starting the hole so that the Forstner bit can be exactly located.

If much work is to be done, it is best to get all three sets of bits. The principal use for boring bits is roughing out wood in the magazine mortises, boring out recesses under a trap butt plate, and a number of similar uses in different kinds of wood work. One or two expansion bits, while not altogether necessary in gun work, are good additions. Figure 2 shows a wood bit to be used in a brace.



Fig. 2
Wood bit for brace—intended for wood only

Braces—Pick out the most dependable for use in connection with auger bits. It should always be a ratchet brace. A Yankee hand drill with a set of small bits is also included under this head, as it is one of the most serviceable hand drills for drilling small holes. It is also an aid for drilling in awkward places.

Bevel Protractor—This is used for laying out angles on both wood and metal and also for checking unknown angles.

Bunsen Burner—This, as well as the alcohol lamp, is very useful for heating or tempering small parts, as a very high temperature can be obtained. It is inexpensive, and if gas connections are available is a great convenience.

Calipers—A set of both inside and outside calipers, 2, 4, and 6 inches, will be needed. These are handy for making quick measurements and to calculate the diameters of work throughout the operations. One 4-inch hermaphrodite caliper is all that is necessary. This is for drawing lines from the sides of a surface to a given measurement, and is a very useful caliper.

Catalogs—See Directory.

Checkering Tools—These tools are very useful, not only to place designs on forearms and pistol grips, but for other designs as well. Imagine a saw, or rather two small saws, about 1 inch long, at

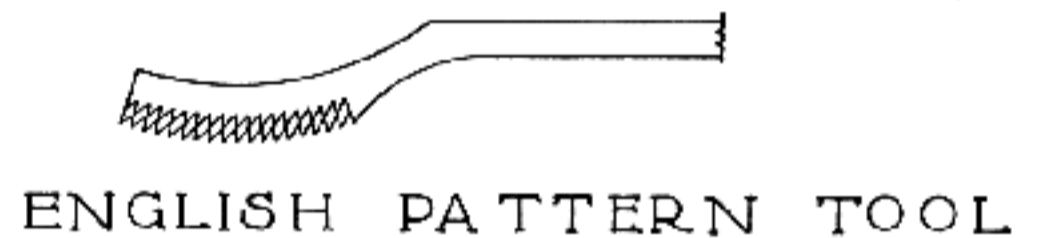
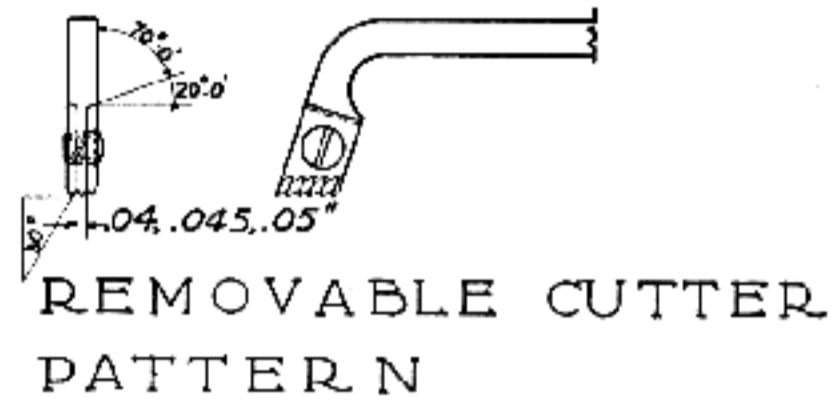
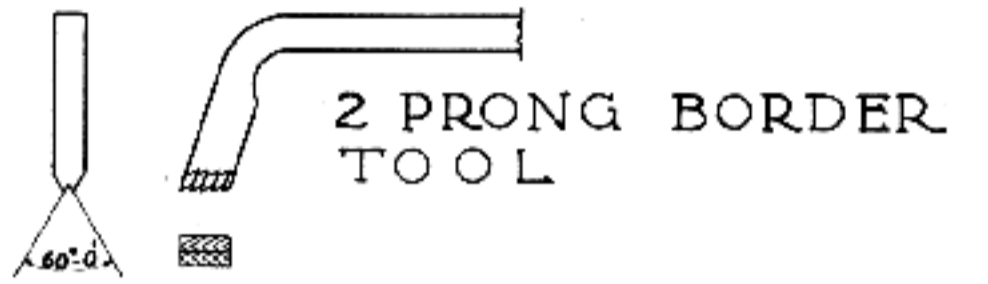
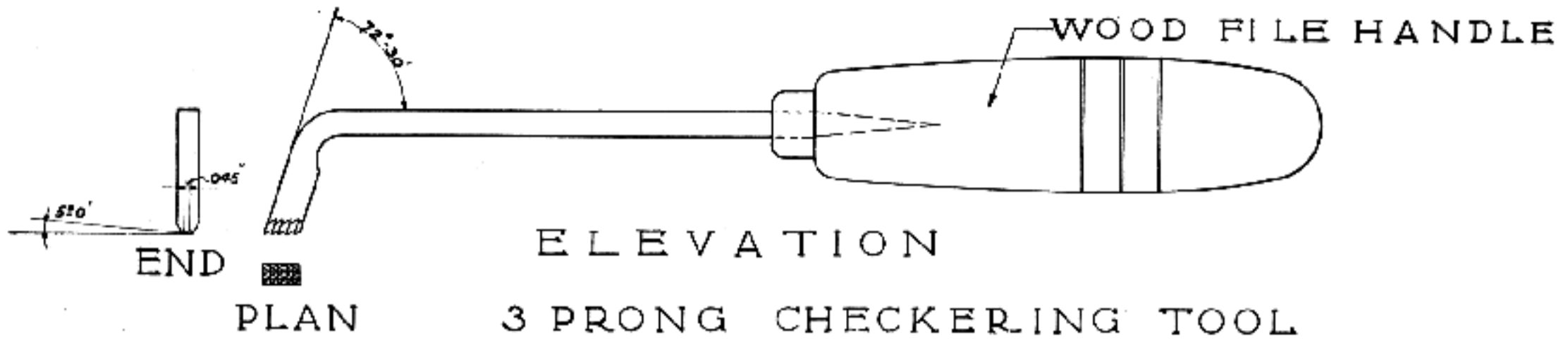

Fig. 3
Checkering tool designs

the end of a straight piece of steel shank looking like a small tooth-brush. Figure 3 illustrates checkering tools. The double saw can be made by filing it as one thick saw; then cutting a groove lengthwise to make two rows of teeth. In using it, one side of the teeth first forms the groove, and afterwards forms the guide, while the other side makes the next cut. As each first cut is finished another mark is being made. This insures equal width of cut. A set of checkering tools consists of the bordering tool, laying-out tool, and two checkering tools for each size of checkers. From point to point of the teeth there should be a distance of .04 and .045. These tools are made from $\frac{1}{8} \times \frac{1}{4}$ drill rod, cutting the rod in 6-inch lengths, heating the end to cherry red and forging the end about 1 inch long at an angle of about 75 degrees.

It will be good practise for the student to undertake filing out his checkering tools, using a three-square needle file and measuring from point to point. For fine checkering (25 lines to an inch) they should measure, point to point, .04 inch wide. The best tools are made with three rows of teeth. While one is cutting, the other is guiding into the groove which has been made previously. The three-

row tool is the hardest one to make, for it is necessary to get accurate measurements. The tools shown in Figure 4 are for milling the cutting teeth

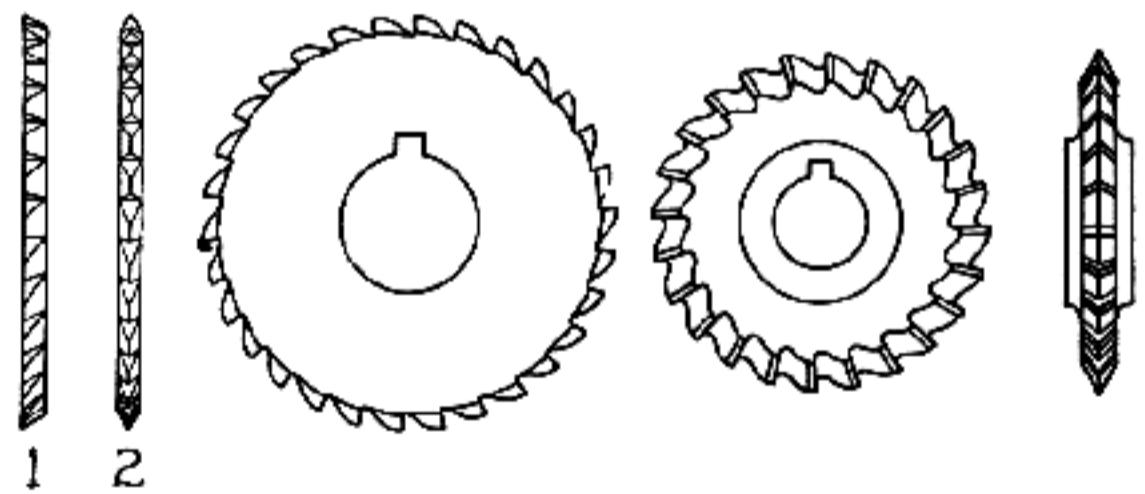

Fig. 4
Milling cutters for making checkering tools

accurately; placing them .040, .045, .050, .055, and .060 apart. The .045 tool gives the best results and makes the best checkering possible on a stock.

After the grooves are cut in the checkering tools lengthwise, it is easy to file out the cutting teeth. To do it more accurately, have them milled out and spaced as finely as possible; then file the sides or cutting edges on an angle, sloping well back; the sharp cutting edge on the outside does all the work.

The teeth may be made almost vertical, or they may slope back slightly as outlined. You can stone these for the different woods you are using, for degree of sharpness is important. After cutting the teeth on both sides, heat the cutter to a bright cherry red and quench in water, polish off with emery cloth, and draw the temper to a light straw color. This leaves it hard and impossible to touch with a file.

If you wish to cut your own checkering tools with a three-square needle file, lay them out, using the die-maker's square to get the first line and estimating over the distance that you wish to space it. Say that you wish to space it .045; this is easy, as these scales are graduated in sixty-fourths, so it is only necessary to set over on the second line to $\frac{3}{64}$, only .001 over the .045, which is near enough. It is very essential that you be careful in filing these spaces to get them the proper width, for if you try to doctor them up by filing the sides of the cutter, you change the height—one will be high and the other low, and you will have difficulty in checkering.

If you do not get just what you wish at first, start over again and get the width that you desire. Circassian, French, and Italian walnuts are the easiest woods to checker, and the checkering on them can be made much finer than on open-grained American walnut or softer woods. Eighteen to twenty spaces to the inch is customary in using the .050 or .055 tool. The laying-out tool is seldom used, as you can lay out your work much better with the three-square bent needle file.

The angle of the checkering tools should be 30 degrees on the side or 60 degrees on the included angle. These angles are the same as the three-square needle files. The border tool may vary according to the width that is pleasing to the eye. The finest checkering does not require a border, for a border is only carried around the checkering to cover mistakes, such as the slipping of the checkering tool and the three-square needle file. It is well, however, to have the beginner use the border tool until he becomes so adept that never a mark will be made outside the outlines of the checkering. The end which is driven into the file handle can be

drawn to a taper so that it may be more tightly secured. The length of the tool from ferrule to point should be between 3 and 4 inches, and from the bend to the checkering teeth, three-quarters of an inch.

The bent file is made from a die-maker's escape-ment file, or a $5\frac{1}{2}$ -inch three-square needle file, #0 or #00 cut. To bend the files at the end, coat with a mixture of bone-black made into a paste by adding oil. Heat to a cherry red and bend on a hardwood block using a slight steady pressure. Coat again with bone-black, reheat to a cherry red, and dip into a brine solution made by adding common table salt to water. This requires very quick work, for the point is so small that it loses heat rapidly, so everything should be handy—the fire, the wooden block and the brine solution—for as soon as you dip the file into the solution, the bone-black comes off and the file serrations are at once clean. The bone-black, of course, is only used to prevent the heat from burning the points of the teeth.

Chisels—These come under the heading of firmer chisels, socket chisels, bottoming tools, gouges, cold chisels, and carving tools.

(a) Firmer chisels: The ordinary carpenters' chisels are too long and clumsy for gun-stocking, but those made for wood carvers are very suitable, especially the short ones made for work in technical schools.

(b) Socket chisels: These are a very short pattern of carpenters' chisels and are useful in the rougher operations. You can buy an assortment of them from any hardware company. You will need a set from $\frac{1}{8}$ up to $1\frac{1}{4}$ inch. You also require a set of offset pattern-maker's gouges from $\frac{1}{4}$ to $\frac{3}{4}$ inch, varying in widths by $\frac{1}{8}$ inch.

(c) Gouges: You may have to undertake the making of your own gouges, as suitable inside-ground gouges are not available. These are made from drill rods $\frac{1}{8}$, $\frac{3}{16}$, $\frac{1}{4}$, $\frac{5}{16}$, $\frac{3}{8}$, $\frac{7}{16}$, $\frac{1}{2}$ inches. The most convenient length is 4 inches from the file handle. File down the drill rod to a taper one-half its diameter on the end used for cutting;

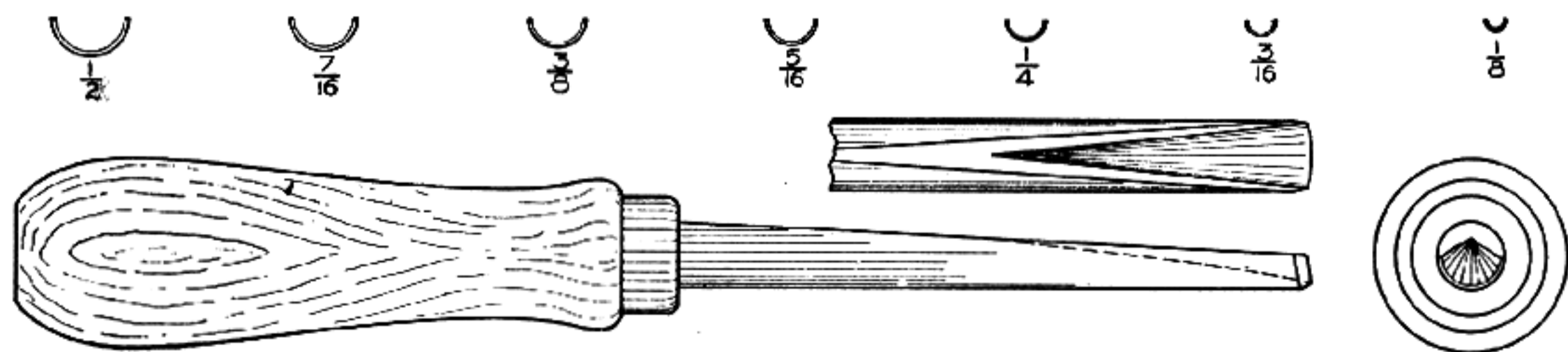

Fig. 5

Wood gouges—easily made from drill rod

then file out the radius of the cutting edge to the proper size and harden and temper in the usual way. Of course it will be necessary to turn the other end down to a lesser diameter in order to drive into convenient-sized file handles. When these tools are made and held to a sharp cutting edge, you will find them very handy on inletting work where small as well as large radii need to be cut very sharp. Figure 5 illustrates these.

(d) Carving tools: The very best carving chisels and gouges are those made by F. V. Addis and Sons of London. They are made from fine Sheffield steel, forged entirely by hand and sold in this country by Hemmacker & Schlemmer and Company in New York City. You will find a number of uses for carving tools, and it is well to invest in a set of these, not only for the different carving work you may want to do, but also for odd forms that may arise in the construction of special woodwork.

(e) Bottoming tools: These must be hand-made, as the ordinary chisels and carving tools will not reach the deep cuts required in the inletting of shotgun actions. Bottoming tools can be made from $\frac{1}{4} \times \frac{3}{16}$ inch drill rods and forged and filed to the shape required in any particular job. It is necessary to head and forge out the ends, so be very particular to keep your heat even and do not attempt to forge the steel when it starts to lose its color; hold it at a cherry red as long as you are working it. After forging, file it to the desired shape, harden, and draw the temper to a purple. The edges may then be sharpened with an oilstone. File down the shanks and fit suitable file handles. You will find as you progress that you will never have enough bottoming tools.

(f) Cold chisels: Buy only a few of the small sizes; these are very seldom used in gun work, but you will find a use for very small ones. Save all your needle files, and by using the ends that are held in the hand, you can make fine chisels. They will hold their edges very well if the temper is drawn to a light blue.

The wood chisel is one of the most important tools a gunsmith owns, so without the finest of chisels he is absolutely helpless. The ordinary carpenters' chisels can be used by the beginner to get an idea of what is required, but for the fine inletting of actions into stocks such chisels are really useless, and good work can never be done with these tools. Always bear in mind that they must be held at a keen razor edge so that they will cut the grain any way it may run.

Clamps—These are used for the purpose of attaching horn, glued wooden insets, ebony, ivory forearm tips; for holding down work on the drill press, for clamping discs to circular wheels on the

grinder, and a considerable variety of other uses.

(a) C-clamps: There are a variety of C-clamps made, but the most useful is the malleable iron, body-builder's C-clamp which comes in openings from 3 to 10 inches. It is essential for the beginner to secure a set of these clamps with openings of 4, 6, and 10 inches. They are very reasonable in price, and while buying it is well to get the set. You can also buy the small cast-iron clamps in the five and ten cent store. These come in handy for a number of things. Even tho they are made of cast iron they serve their purpose very well on small work. There are a number of odd forms of clamps you must construct yourself as you find uses for them.

(b) Stearn's improved bar clamp: This is one of the handiest clamps of its kind, and comes in various lengths. A five-foot clamp is very convenient for a number of jobs, and can be bought so reasonably that it does not pay to make it. You can get the shorter clamps of the Stearn's variety for all the work in the gunshop.

(c) Butt clamp: As every gunsmith knows, this is a very handy clamp and worth making up. It is used largely in stocking shotguns and single-shot rifles. The end pieces are $\frac{1}{2} \times 1 \times 6$ -inch cold drawn steel, with $\frac{7}{16}$ holes drilled 4 or 5 inches apart. On these are placed two long $\frac{3}{8}$ bolts, threaded on each end, and long enough to reach from the action to the butt of the stock blank. Care must be taken in tightening the nut on the opposite end so that equal pressure will be applied. It is important to equalize and tighten the two nuts at the same time. Figure 22 illustrates one of these clamps.

(d) Wooden hand-screws: These are very handy for holding sections that are glued to stocks, also for holding forearms in place; in fact they have a number of uses on woodwork where metal clamps cannot be used.

(e) Tool-maker's parallel clamps: It is well to secure sets of these clamps, for they will be much used in metal work, such as holding in place telescope and sight bases of all kinds and descriptions, and also for clamping work to face plates, angle plates, and lathe-face plates.



Fig. 6
Fluted countersink

Fig. 7
Half countersink

Countersinks—These are made in various angles—45, 60, and 82 degrees, and are used for countersinking metal and wood. Figures 6 and 7 illustrate two standards used.

Dies—The beginner should secure round button dies of the following sizes, together with a suitable die stock. It is wise to get sets made up in these small convenient sizes:

2-64	6-48	10-30	¼-28
2-56	6-32	10-24	
3-56	7-36	12-28	
3-48	7-32	12-24	
4-48	8-36	7/32-32	
4-36	8-32	¼-20	
5-40	10-32	¼-24	

One set put out by the Pratt and Whitney Company ranges from 1/16 to 1/4 inch in sixty-fourths. This set includes the corresponding taps. A full set will be found expedient.

Spring Dividers—A set of three tool-maker's roundleg dividers in 2, 4, and 6 inch sizes for laying out work is necessary.

Drill Sets (Twist)—Drills come in different sizes and are classified as number drills, letter drills, and fractional drills. It is well to buy a full set of them to begin with. Number drills come in sets from 1 to 80; letter drills come in sets from A to Z; and the fractional-size drills come from 1/16 to 1/2 inch in sixty-fourths. If you intend to do much work, the sets of high-speed drills are best. After finding what drills you use most, secure one or two extra ones of this number, letter, or fractional size, so that if one is broken your work will not be delayed. Figures 8 and 9 illustrate fractional and number sets.

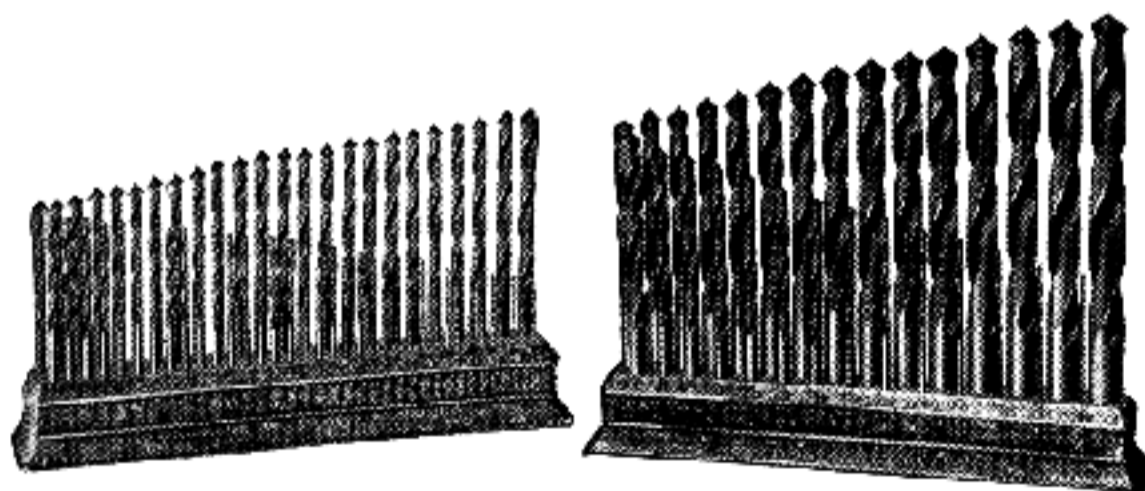

Fig. 8 Drill set in number sizes Fig. 9 Drill set in fractional sizes

Drill and Wire Gauge—Starrett's #185 gauge is a necessary tool, as you will refer to this more than any other outside of your micrometer. Also get a fractional-size chart and the letter-size chart. All these come in handy for checking the diameters of round stock, and also for measurement when turning work in the lathe. Figure 10 shows fractional and number drill gauges.

Drill Press—This is one of the machines that an amateur really requires, not only for drilling holes, but for rotating work when filing screw heads, polishing round pieces of steel, or damaskeening steel such as is seen in fine watches. Damaskeen-

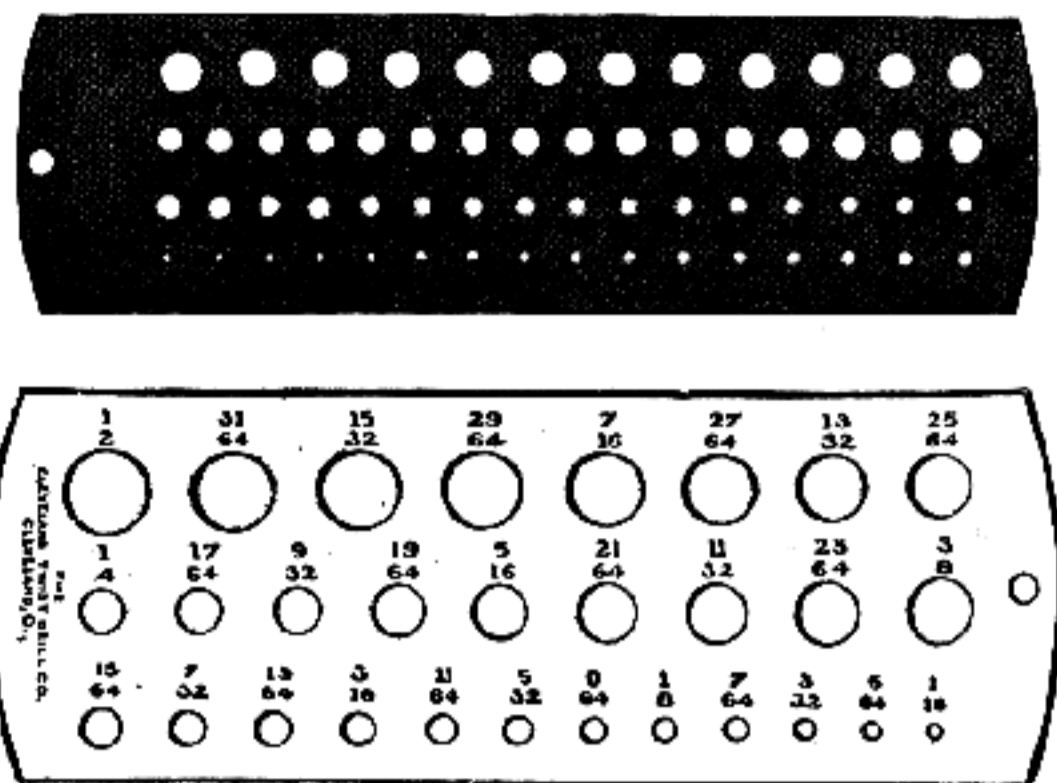

Fig. 10 Drill gauges in number and fractional sizes

ing is discussed in Chapter XXII. A drill press can be converted into a mortising machine by putting suitable stops in the proper locations and can even be used for facing wood by using end-mills where it would otherwise be impossible to get two faces absolutely parallel to each other. A drill press can also be used as a milling machine when you wish to file out small cutters or make slots in sight bases, shotgun hammers, tumblers, etc. It is also useful in places where it would be difficult to do work in any other manner, such as milling out stock for odd inserts of bone, ivory, ebony, and buffalo horn.

One of the best drill presses for gunmakers on the market today is the Canedy-Otto, a motor-driven sensitive drill press, with two separate tables. The upper one can be swung out of the way and the bottom table used for work of larger size where a similar center is required. The centers are furnished with this machine. The spindle has a #2 Morris taper and is also adapted to the use of a #3 Jacobs' Drill Chuck. It will be best for the gunsmith to save up his funds and invest in such a machine if he intends to carry his work to a high degree of perfection. Figure 11 illustrates the Avery Drill Press.

Delta Sanding Drums—These are made by the Delta Supply Company and can be used on the spindles of the electric Apex grinders mentioned before. They can be used for polishing convex and concave surfaces and for the removal of old varnish, dirt, or rust. The sandpaper on these drums can be changed very quickly as it is attached mechanically.

Draw Knife—The draw knife is not an essential tool in the gunsmith's list, but if one is adept in its use it can be employed to good advantage in the rough-shaping of a stock.

Electric Glue-Heater or Glue-Pot—The Liberty

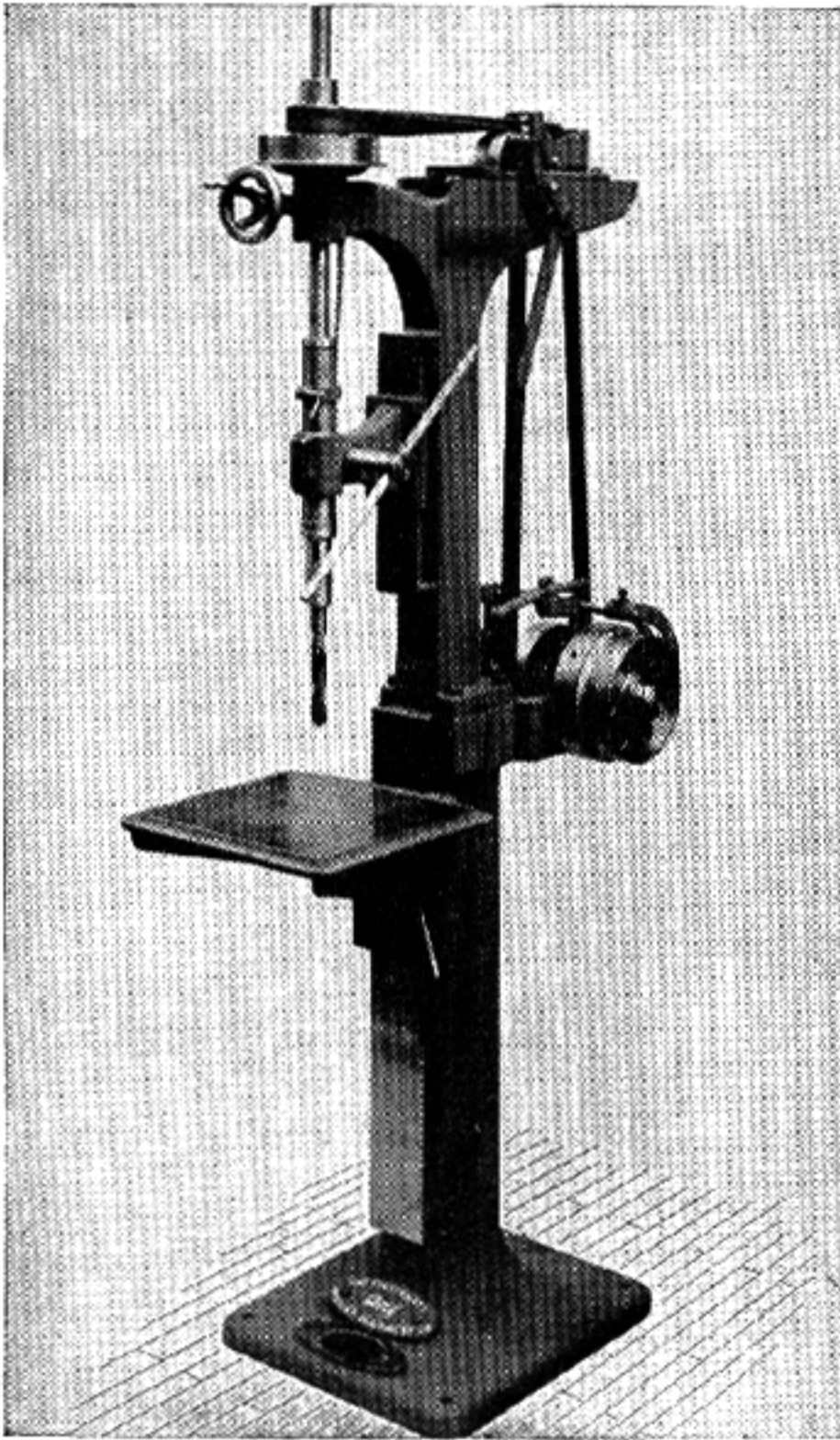

Fig. 11

Avery tool-room drill press: An essential machine in gun shop, machine shop, or laboratory

Electrical Company of Indianapolis puts out one of the best glue-pots manufactured today, one which is operated on the same principle as the fireless cooker. The pint size is the most convenient for the small shop. If you do not have an electrical connection, the regular cast-iron glue-pot will answer the purpose very well.

Electric Soldering Iron—This is a great convenience, but the ordinary soldering iron will answer the purpose just as well. An iron of this type is not used very often in the shop, as most parts are sweated, but if one intends to do much work, it is well to have one on hand.

Files—A real mechanic takes great pride in his files, gives them the best of care, and when they are worn out, converts them into scrapers, chisels, or any number of other useful articles. I would not advise you to make your own files. It is a difficult proposition calling for considerable experience, and I do not believe the results would compensate for the effort, inasmuch as ready-made files can be bought so reasonably. However, if you do need one other than the standard line, all that is necessary is to grind a blank to the desired shape. The experienced file maker holds a chisel

at the correct angle and strikes a blow with the proper hammer, raising a burr. The chisel is then rested against the burr and the following cut is made. File makers work very fast and accurately, and you would be surprised to see just how quickly a flat file can be finished perfectly.

If you look closely at a Swiss file, you will find the spacing remarkably even. The best small files are made in Switzerland, and they are entirely cut by hand. Of course the large file makers of this country have special machines to do this work, but no machine has ever equaled their hand work.

Files are divided into different classes: cross-cut, mill, double-cut, bastard files, and rasps. They are numbered according to their degree of fineness or coarseness—from #00 to #6, or from smooth second-cut to coarse and bastard-cut. Single-cut files have single, unbroken, coarse chisel-cuts across the surface parallel to each other but oblique to the sides. They are used on lathe work and by the machinist. They are also used by wood workers and stock makers. Double-cut files are made coarse, second-cut, smooth, and bastard, and are cut with two chisel cuts crossing each other, the second course with rare exceptions being finer than the first. These are especially adapted for use in the workshop. Rasps are cut coarse, second-cut, and smooth. They have teeth which are disconnected from one another, each tooth being made separately by a punch. These are used by blacksmiths, plumbers, wood workers, etc. They are the files which rough-cut the stocks and other irregular forms where an edge tool cannot be used successfully.

LIST OF FILES FOR THE BEGINNER

- 1—16 inch round file
- 1—12 " " "
- 1—8 " " "
- 1—6 " " "
- 1—12 " flat Cabinet rasp
- 1—8 " " " "
- 1—12 " half-round Cabinet rasp
- 1—8 " " " "
- 2—12 " flat bastard files (1 for metal)
- 1—12 " " mill file (1 for metal)
- 2—8 " " " " (1 for wood)
- 2—8 " bastard files (1 for wood)
- 2—10 " half-round files bastard cut
- 2—6 " " " " " "
- 1—8 " crossing file #2 cut
- 1—6 " " " #2 "
- 6 assorted narrow pillar files in different cuts
- 2—6 inch three-square files
- 1—2 " warding file #2 cut
- 1 doz. assorted 5½ inch needle files
- 1—6 inch Barrett file
- 3 three-square die-sinker's escapement files

It is not necessary to purchase all the files on this list at one time, but add gradually to your collection as you need them. Some you will be able to find in the five and ten cent store.

File Brush—This is a very necessary yet inexpensive addition to your list of tools. With this convenient brush you can clean the file of chips.

File Handles—These are used in connection with the files. Do not attempt to use files without them, as they cannot be properly held and are dangerous as the tang may run into the palm of your hand, thereby inflicting a severe wound with the possibility of blood poisoning.

Furnace—This may be a gasoline torch, alcohol torch, blacksmith's forge, electric or gas furnace. A gasoline torch will satisfactorily answer the needs of the novice, but as you progress, a gas furnace, or if without gas, a blacksmith's forge must be added when heat is required to forge steel, and to harden and temper different classes of work.

Gauges:

(a) Surface gauge: This is the tool maker's type of gauge and is used for laying out work in connection with the surface plate.

(b) Auger-bit gauge: A device to clamp on wood auger bits to regulate measuring depths of holes.

(c) Marking gauge: This gauge is a device to scribe a straight line at a given distance parallel from a side. It is very useful in stock work.

(d) Depth gauge: A 6-inch Starrett or Brown & Sharpe depth gauge is very handy for measuring distances from surfaces.

(e) Screw-pitch gauge. You must have this essential tool on your list. Procure one that reads up to sixty threads per inch. With this gauge you do not have to guess at the threads by counting them with a scale as did the old-timers. That was all right, perhaps, for coarse threads, but practically impossible for fine threads.

(f) Thickness or feeler gauge: This gauge reads from .0015 to .025. It is very useful in checking the opening between cylinder and barrel on revolvers, and a number of other places in gun work.

Hammers—As you will need so many different hammers, you will find that it pays to make these as the needs arise. A light hammer is the most useful, so of course you must have one; then you must have the heavier machinist's hammer for forging, and a hammer with a copper head. The last can be made easily, and is necessary for removing dents from shotgun barrels and other work that might otherwise be marred. Make a fiber hammer for use on polished surfaces by securing a $\frac{3}{4}$ inch thin brass tube $1\frac{1}{2}$ inches long and inserting a piece of round fiber, letting the fiber project from each end of the tube $\frac{1}{4}$ inch, and fit to a handle.

Indicator—This is only necessary when you reach the advanced stages of metal work. It is

used to get work in balance and to run perfectly true in the lathe or to check the true surface on the laying-out plate.

Ladle—A small-size ladle is necessary for melting lead for many purposes, such as making bullets or vise jaws, and hardening springs.

Lathe—This is one tool that is absolutely necessary for a great deal of important work. It is rather expensive for beginners, but a number of small motor-driven lathes are now available at reasonable cost.

Lathe Dogs—These are most satisfactory when made by oneself. They are used only on lathe work and for driving work between centers.

Matting Tools—These are used for matting ramps, sight bases, ribs, and for borders in fancy checkering on pistol grips and forearms. They can be bought from a jeweler's supply house (name given in Directory), but for ordinary matting you can easily make your own. The operation may seem puzzling at first, but after you have become accustomed to their use, it is very simple. Taper one end of a $\frac{9}{32}$ square drill rod, file out the end with a small fine slitting file just as you would checker a stock, only have the teeth come up sharply. Harden and draw the temper to a very dark straw color.

Mallet—The novice must have at least two mallets made—one of rawhide, the other of wood. The rawhide mallet is the most serviceable, as you can use it in metal work as well as in wood work.

Micrometers—This is one of the most essential measuring instruments and a tool which can not be overlooked in the craftsman's collection of tools. Nor is there any economy in the purchase of a cheap one, for in gun work measurements are required as small as one-ten-thousandths of an inch. It would be best to buy either a Brown & Sharpe, or Starrett micrometer, graduated to read ten-thousandths of an inch in 1 and 2 inch sizes. The 1 inch micrometer has a measuring range from 0 to 1 inch by thousandths on the sleeve and thimble scales. With the vernier scale which is on the sleeve, readings in one-ten-thousandths can be secured. The thumb-piece on the end is provided with a click for securing the correct measurements with uniform tension. Many mechanics have a touch so sensitive that the end thimble is seldom used, but for the beginner it is well to secure the necessary practise.

There are other measuring instruments made, such as the vernier caliper, and height gauge with the vernier scales for setting to the correct measurements, but these are not necessary until you have advanced to special experimental work. Such instruments are also expensive.

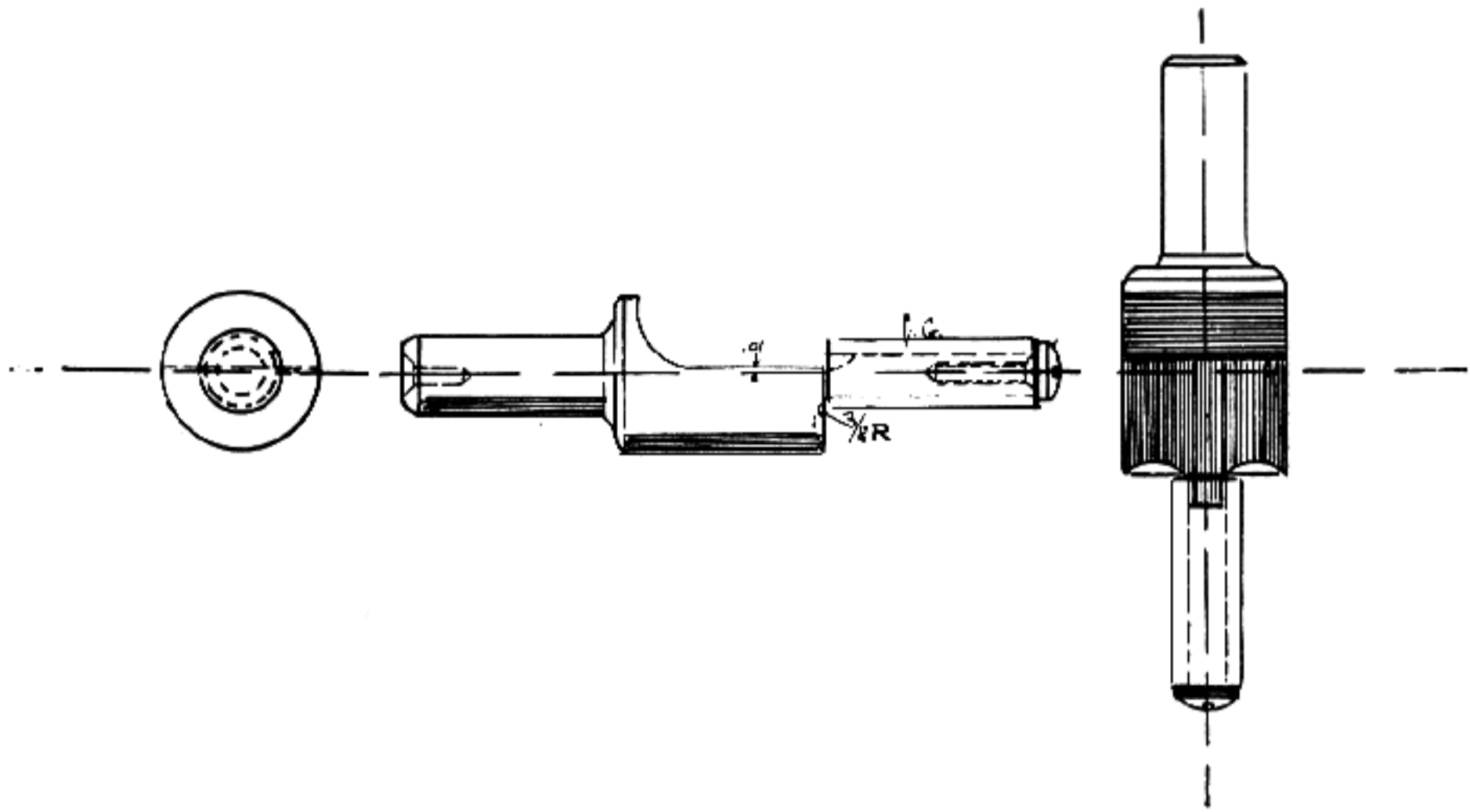

Fig. 12
Barrel-muzzle reamer

Muzzle Reamers—These are made for crowning or finishing the muzzle of a rifle barrel. Great care must be taken in the operation, for accuracy depends very largely on how perfectly the bullet leaves the muzzle. The proper method is to use a barrel plug and true the outside perfectly in relation to the bore, and then crown the end with a specially ground lathe tool to the correct radius. Not all amateurs are so fortunate as to have a lathe, so one must make a special tool, as shown in Figure 12, which may be used in the drill press. In using this device have some one revolve the press by hand so that you can use both hands in order to apply the proper pressure. It can also be done by using it in a hand brace, but one must make sure that the cutter does not chatter while revolving. A good plan is to have a local machine shop turn up a blank as shown and then file it so that there is a $\frac{1}{16}$ -inch cutting edge, and have the cutting edges slightly beveled in opposite sides. Harden and draw the temper to light straw color. Have the cutting edges very sharp. The pilots of these tools must be stoned or, better still, ground to the exact bore of the rifle. If they are not ground they must be lapped so that there are no tool marks whatever, for a rough pilot will ream out the rifling. Great care, therefore, should be shown in making these cutters perfectly smooth and true.

Magnifying Glass—A very handy and inexpensive instrument for the inspection of surfaces, muzzles, etc., as a means of detecting any scars on surfaces, and for inspecting the cutting edge of a honed reamer. Figure 13 illustrates one that can be made; but first purchase a standard jeweler's glass and set it into the holder shown.

Miter Box—A trough-shaped form for holding work and directing the saw when cutting squares and miters. A satisfactory miter box is easily made, but if you have to do very much inletting, it would be well to procure the Perfection Iron Miter Box, since with this you can get any angle required.

Oilstones—It is well to have all shapes and sizes of oilstones, buying them as you need them. One that is necessary is the 3 x 2 x 1 inch combination of India and Wachita for honing wood-working tools. The coarse India will be found exactly right for cutting the hardest steel with ease, and the Wachita insures a keen lasting edge. This stone finds its greatest use in sharpening wood-cutting tools.

You will also require a lily-white Wachita 6 x 2 x 1 inches for the final sharpening. A carborundum slip-stone with a round edge for sharpening gouges, radius tools, and carving tools will

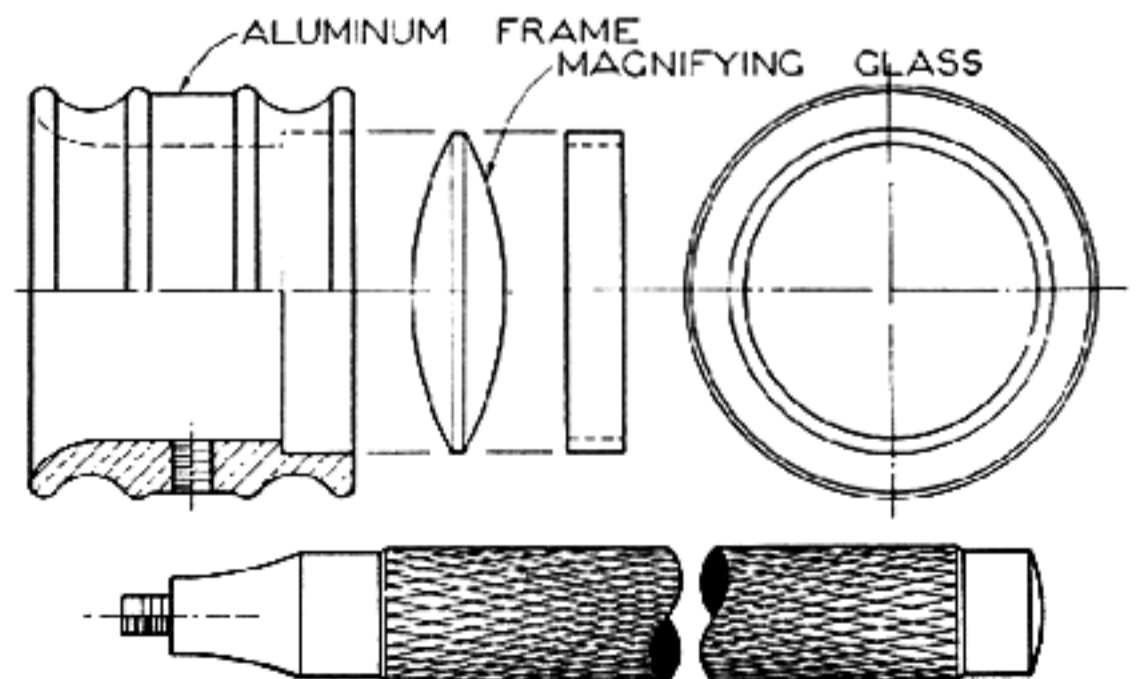

Fig. 13
Magnifying glass and holder

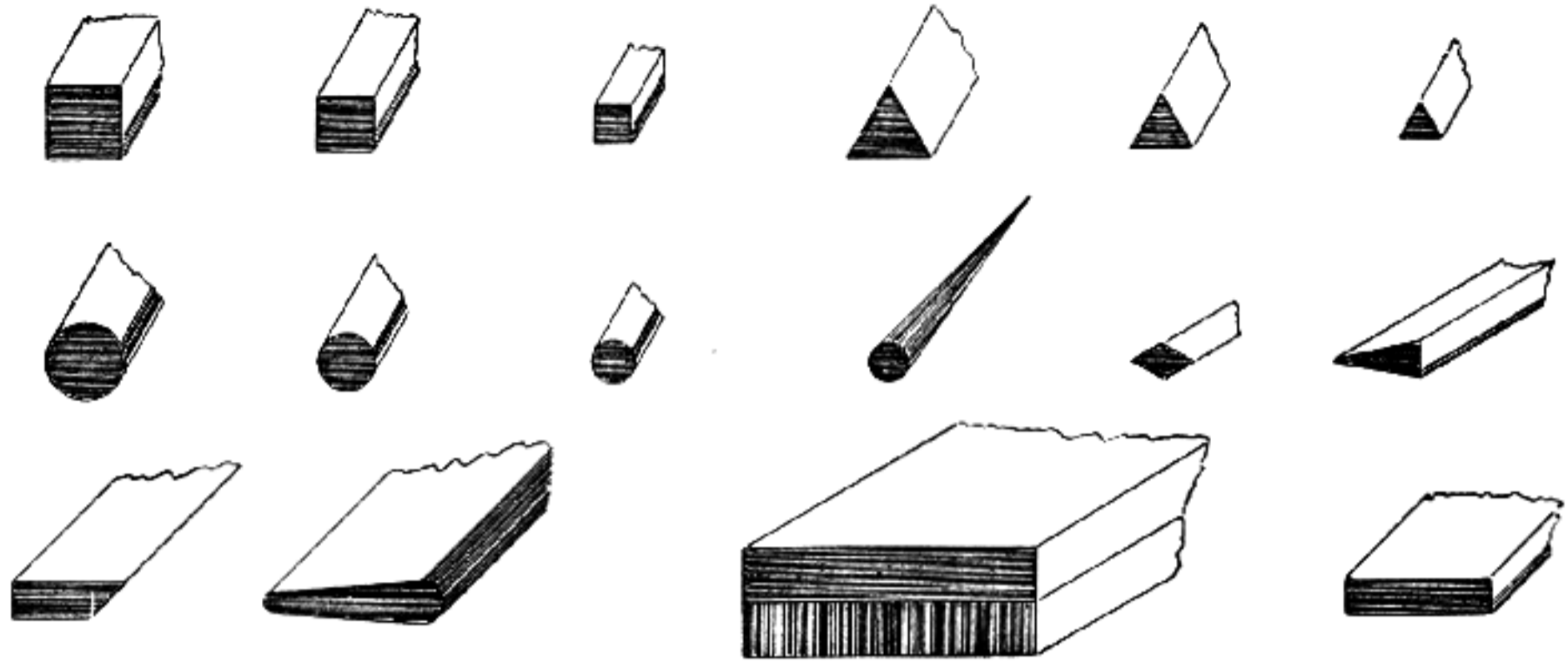

Fig. 14
Shapes of oilstones

also be needed. Carborundum and aloxite stick may be had in square, triangular, half-round, round, and pointed. These come in three different grades—fine, medium, and coarse grits. The Pike India oilstones can be had in a great many odd forms and shapes. There is also the Arkansas stone in two grits, hard and soft. For the finest work the hard Arkansas stones are best to put the final finish on a hardened surface, such as sear and trigger work, reamers, and cutting tools. The various forms are shown in Figure 14.

Oil Cans—One or two of these are necessary.

Pans—Small tin pans are handy for the reception of parts when rifles or shotguns are taken apart. Suitable boxes may be used.

Parallels—Inexpensive parallels can be made from cold-drawn steel 6 to 7 inches in length in the following sizes:

$\frac{1}{8} \times \frac{1}{4}$ inch; $\frac{1}{4} \times \frac{3}{8}$ inch; $\frac{1}{4} \times \frac{1}{2}$ inch; $\frac{1}{4} \times \frac{5}{8}$ inch; $\frac{3}{8} \times \frac{3}{4}$ inch; $\frac{3}{8} \times 1\frac{1}{4}$ inches. These are very necessary to lay out work on the surface plate, such as sight bases, ramps, telescope blocks, and a number of other articles. When it comes to fine precision work, only hardened and ground parallels must be considered.

Plates—These come under the heading of bench and angle plates, surface plates, dowel-pin plates, lapping plates, and cast-iron plates for truing oilstones.

(a) Dowel-pin plates: Figure 15 shows how these are made. This is one of the most useful tools for the wood-working bench and is usually permanently fastened to one end of the bench. When you have holes drilled and reamed from $\frac{1}{16}$ to $\frac{3}{4}$ by $\frac{1}{32}$ and $\frac{1}{16}$ inches you can make a dowel-pin by sharpening the rough dowel nearly to size

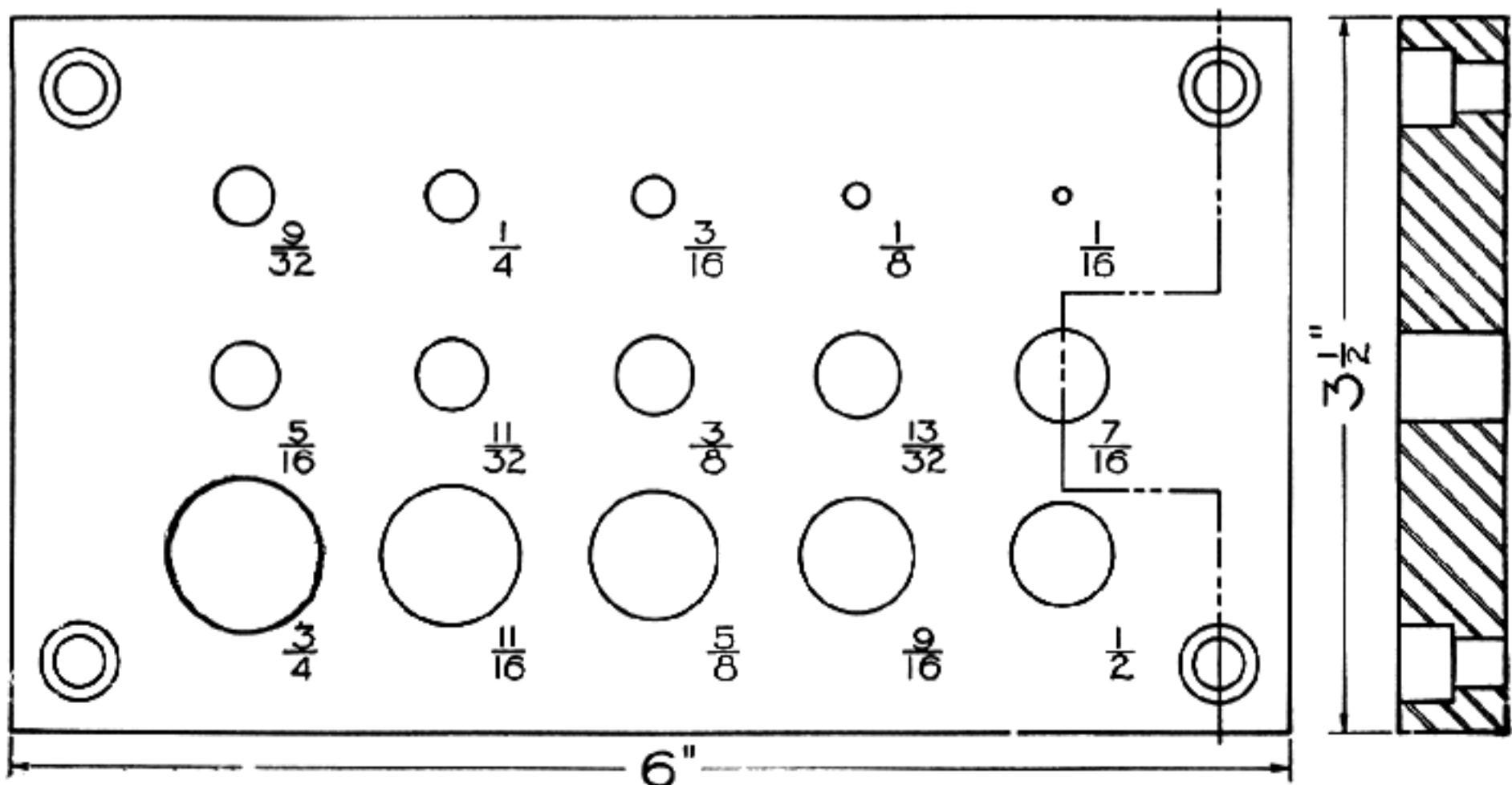

Fig. 15
Dowel-pin plate

and then forcing it through the required-size hole.

(b) Lapping plates: These are used to lap a true parallel surface. While not necessary for the beginner, as he advances into fine precision work he will require two of these plates, one of iron and one of lead. The one of cast iron should be 1 x 10 x 10 inches with the surfaces perfectly true, one side checked about $\frac{1}{2}$ inch apart, and *charged* with fine abrasive. The lead lapping plate is made on a cast-iron base 1 x 10 x 10 inches with a number of holes drilled in the surface about $\frac{5}{16}$ deep, then boxed in on all sides and a 50-50 mixture of lead and tin poured until a $\frac{1}{2}$ -inch thickness is built up from the surface of the cast-iron plate; this is then planed off smooth. You then have a lapping plate that you can use for fine abrasives only, using the emery or dry rouge on the lead plate to secure a very high finish on a surface. On the cast-iron plate, use the finest emery and olive oil.

(c) Oilstone plate: A cast-iron plate 1 x 10 x 10 inches is planed off to a smooth surface and used to true oilstones as they become worn to an uneven surface. It is impossible to do your best work with uneven oilstones or stones which have become clogged from use, so you must true up your stones. Use from 90 to 120 carborundum and water. This cuts the surface of an oilstone very fast, and in a short time you have a perfect stone again.

Planes, Wood-working—These come under the headings of block, jack, smoothing, and rabbet planes. All of these are used in stock and cabinet work, and of course every one is more or less familiar with the jack plane, block and smoothing planes from their general use in all wood work. Get these three to begin with, and if you can pick up some of the old-time wooden planes our forefathers used, add these to your collection. Some work is still best accomplished with these. Their use in stock work will be discussed in Chapter IV.

(a) Rabbet planes: As a general rule there is very little call for such a plane in stock work, but for special jobs outside of stock work there is often a place for it. A router plane is a plane-like tool under that name. This is used for surfacing a flat bottom when you wish to put in an inset as on the forearm, or to rout out a channel where you wish to place a special insert. This plane saves a lot of time.

(b) The spoke shave: You will find this tool one of the most useful in stock work. There are a number of different forms of spoke shaves, and you will readily become familiar with their use. They are inexpensive and a variety will add to your ease in working. If they are kept at a keen cutting edge they will enable you to form up a stock to far

better outlines than with a wood rasp. There is a spoke shave of orange wood called the "Little Wonder" made by W. Johnson, of Newark, New Jersey; the stock is of wood and is perfectly shaped to get around odd forms; the cutter is of good steel, and you can maintain a good cutting edge at all times. If the blade should become loose in the handle, all that is necessary to tighten it is to place two wood screws against the tangs of the cutter which goes through the handle. Stanley also makes different forms of iron spoke shaves, and these can be added when the need arises. The chapter on stock work explains the use of these in detail.

Punches—These come under the headings of prick punches, center punches, drift punches, nail punches or nail sets, and wood punches.

(a) Center or prick punches: The best punches are those you make yourself from worn Swiss needle files. You can use both ends, making them in about three-inch lengths, ground round, and the temper drawn to a purple. The next best center punch is of a smaller size and made from dental burrs. Altho these burrs are small, they are convenient for laying out where fine center marks are required. As it is not necessary to draw the temper on these, you can grind up at least six and place them in a block. Of course you can buy center punches such as the Starretts' automatic adjustable-stroke center punch, but the ones you make yourself are the best. You will also need a one-quarter-inch center punch, and this can be made of drill rod, hardened and the temper drawn to a blue.

(b) Drift punches: These can also be made of $\frac{1}{4}$ and $\frac{3}{16}$ inch drill rod, from $\frac{1}{16}$ to $\frac{1}{4}$ inch ends. You can have your local machine shop make a set of these. It is also a wise policy to have two of each size, as you break them often. For the smaller sizes, dental burrs are the best as they hold up very well. You will find that dental burrs play a large part in gun work, so the next time you go to your dentist, ask him if he has a box of burrs that have become too dull for him to use any longer.

(c) Nail sets, or nail punches: A set of these can be bought very reasonably. Have them annealed and the ends turned down for a length of about 1 inch. Rearden and draw the temper to a blue, and polish out the cupped end. These punches are required to drive the round-headed pins out of fine shotguns, as a cupped punch of this nature does not mar the ends.

(d) Wood punches: These punches have cupped ends made from $\frac{3}{16}$ and $\frac{1}{4}$ inch drill rods—the cutting edge made sharp by tapering from the rod size back about $\frac{1}{2}$ inch to the desired size you wish

to make the point. The sizes are from $\frac{1}{16}$ to $\frac{1}{4}$ inch in $\frac{1}{32}$. Such punches are used to make a beaded border on fancy checkering and in a number of places to improve the design of wood carving.

Polishing Wheels—If you have a buffing head or intend to use one side of your Apex electric grinder, you will find it necessary to procure the following buffing wheels, 8 x 1 x $\frac{1}{2}$ inch hole: muslin, cotton, flannel, woolen, felt, chamois, buckskin, leather, and sheepskin. Also get an Utility Electric Motor and a small set of polishing wheels, as the list shows, to polish small parts.

Tap Wrenches—Add these to your list along with the wrenches to take the different sized taps.

Pliers—Go to any hardware store and pick out a number of different kinds. You will find them very necessary.

Reamers—Under this heading come hand reamers, taper-pin reamers, rose, chucking or machine reamers, English broaching reamers, chambering reamers, expanding reamers, counterbores, and burnishing reamers.

You will find that a number of years are required to collect all the reamers needed. Of course it is possible to purchase a great number of reamers, such as the standard sizes, still these are not satisfactory, as the relief is ground on these reamers for the every-day needs, while to obtain the most satisfactory results you must stone a reamer to the cutting edge to get a perfectly reamed hole. I make most of my reamers and have a good many, yet not a day passes that I do not need a new one. Here I shall only skim over the reamers and their purposes; in a later chapter I shall go into detail.

(a) Hand reamers: These can be had in sizes as needed. They come in sets from $\frac{3}{16}$ to 1 inch and you will find very little use for the large sizes in gun work. They can only be used by hand, using a tap wrench to pass them through the holes. Never use this form of reamer in a machine such as a drill press or lathe.

(b) Taper-pin reamers: This class of reamer has a taper of $\frac{1}{4}$ inch per foot or .0208 inch per inch. There are two classes of these reamers, one for hand use and the other for use in a drill press or lathe. The hand reamers are those required by the gunsmith and come in sizes from #000 to #13. They are so proportioned that each overlaps the

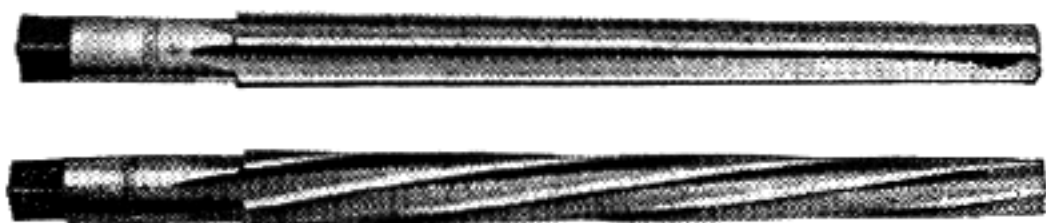

Fig. 16

Taper-pin reamers, straight and spiral fluted. The latter produces superior results

size smaller about $\frac{1}{2}$ inch, so the necessary set is from #000 to #8. Figure 16 illustrates the two most generally used.

(c) Rose chucking or machine reamers: Only buy these as you need them, for in time you will make a set. Purchase the size near the particular size required, then grind it and stone the cutting edge so the hole comes to the desired size. Shown in Figure 17.



Fig. 17
Machine reamer

(d) English broaching reamers: This is the type of tapered reamer used by watch makers and jewelers. They come in smaller sizes than the taper-pin reamers, so get a full set of these. They not only come in handy where it is necessary to fit a small tapered pin, but to ream out sight apertures to any desired size. William Dixon of Newark, New Jersey, carries a full line of such tools.

(e) Cherries: These are used for making bullet moulds and must be made specially when you have an idea for a new form of bullet or for a special-size round bullet.

(f) Barrel reamers—chambering reamers and burnishing reamers: A chapter on barrel making in the second volume deals with these.

(g) Expanding reamers: In this type of reamer the flutes are slotted and have either a taper pin or nut on the end to expand the flutes. It is very seldom used in gun work, and besides is very expensive. One is illustrated in Figure 18.



Fig. 18
Expanding reamer

(h) Counterbores: Counterbores are used to make a flat-bottomed hole. They have a pilot to fit a drilled hole, so that the counterbored section of the hole will come perfectly true with the drilled hole. They are used in connection with fillister-head screws and a number of other purposes in gun work. This tool must also be made, as you cannot buy the sizes required. A flat-bottomed drill, ground up, will answer in a number of cases where the work is not too particular. Counterbores are used in a number of places on stock work where a counterbored hole is required to fit insets of buffalo horn, ivory, ebony, where a drill so used would break out slivers, an accident which must not happen on a finished stock. You will find that counter-

bores are like reamers. It requires a long time to collect a set. Figure 19 shows a standard counterbore.



Fig. 19
Counterbore

Rules or Scales—These come under the headings of steel scales, flexible scales, boxwood rules, etc. Everyone is familiar with this form of measuring instrument. Purchase one 6-inch and one 12-inch flexible-scale rule graduated in sixty-fourths and hundredths. Also one heavy yardstick and a five-foot folding rule to measure any desired length. The 12-inch flexible rule can be used for laying out checkering and other laying-out work, also to secure lengths or distances to space telescope blocks; in fact, these two scales are used more than any other measuring instrument.

Saws—Under this heading are hand-saws, hack-saws, jewelers' hack-saws, coping saws, etc. For the wood-working department you will need two hand-saws, one rip-saw, and one cut-off saw. In metal work you will need a hack-saw measuring about 12 inches. There are many different kinds of hack-saw frames and it is best to suit your own taste in this respect. However, be sure to obtain the best, as a hack-saw plays a great part in the gunsmith's trade. Buy only the best blades, such as the Atkins silver-steel blades with teeth from 20 to 32 per inch, the fine teeth for thin metal and the coarse teeth for wood and steel. Also get a jewelers' hack-saw frame with a large selection of blades. These blades only cost 10¢ per dozen, so have a dozen of each grade on hand. A coping saw is also very useful in wood work, and these are very reasonably priced.

Scribers—The best ones are made from dental burrs by grinding a very sharp point on one of the small burrs; then stone the point to a sharp edge,

and make a small round handle from either ebony, fiber, or buffalo horn. The ones you buy are much too heavy and your lines will vary when taken from a straight edge or scale. A very good knife-edge scriber can be made from a worn hack-saw blade by grinding off the teeth and grinding the end to an angle similar to a fur-cutter's knife, and honing it to a keen edge. This is used in laying out lines on wood work, such as you lay out for the beginning of a stock.

Straight Edge—Figure 20 illustrates a straight-edge. These can be made of thin hard wood. One of their uses is to determine the amount of drop and pitch of a rifle. This is easily measured by fastening a thin piece 10 inches long transversely at one end.

Scratch Brush—This is used to prepare surfaces for the bluing operation and is obtainable at gun-parts supply houses. See Directory.

Screw-drivers—These are among the most essential tools, so by all means have a good supply, ranging from the small jeweler's screw-driver to a large long one for removing butt screws, such as hold the action to the stock in Remington, Ballard, and Winchester rifles.

The best screw-drivers are those made from octagon chisel steel, short in length and with a large file handle attached. Very good ones are also made from drill rod, but when it comes to strength, the octagon chisel steel holds up best of all. Spend a day making up a good set, such as Figure 21 illustrates. You will find that it pays in the end, for screws that are put in at the factory are very tight and their removal requires a driver properly fitted to the width of the slot. If it does not fit and the driver should slip, the result will be a badly marred head. You will find that on all shotguns the screw slots are very narrow and the screws very tight. These screws have been set up with a screw-driver bit used in a brace. You must then make a set of these from octagon chisel steel with the end filed to fit the screw and *without any taper*, for when you taper a screw-driver bit it

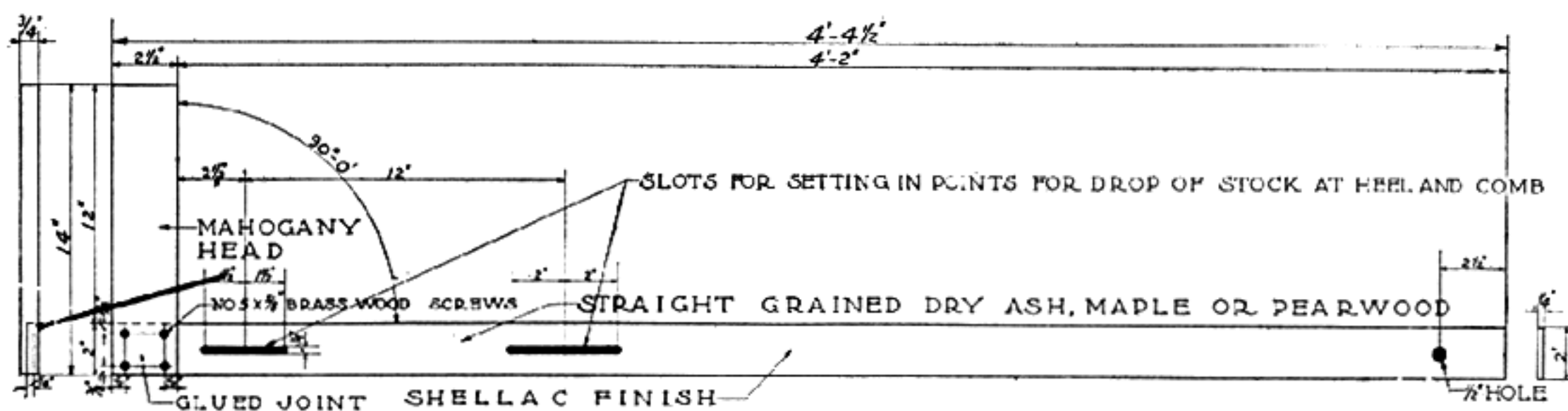
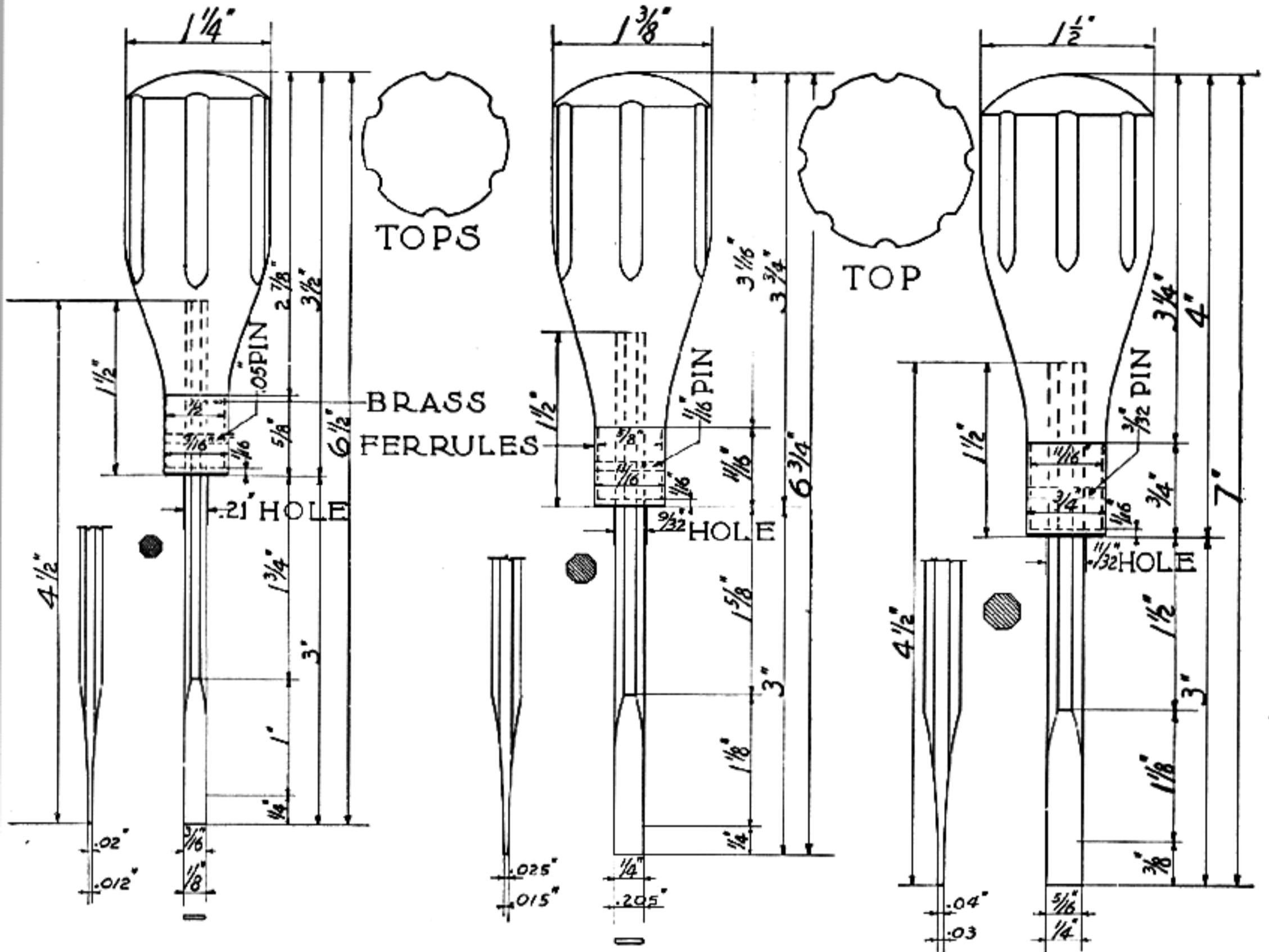
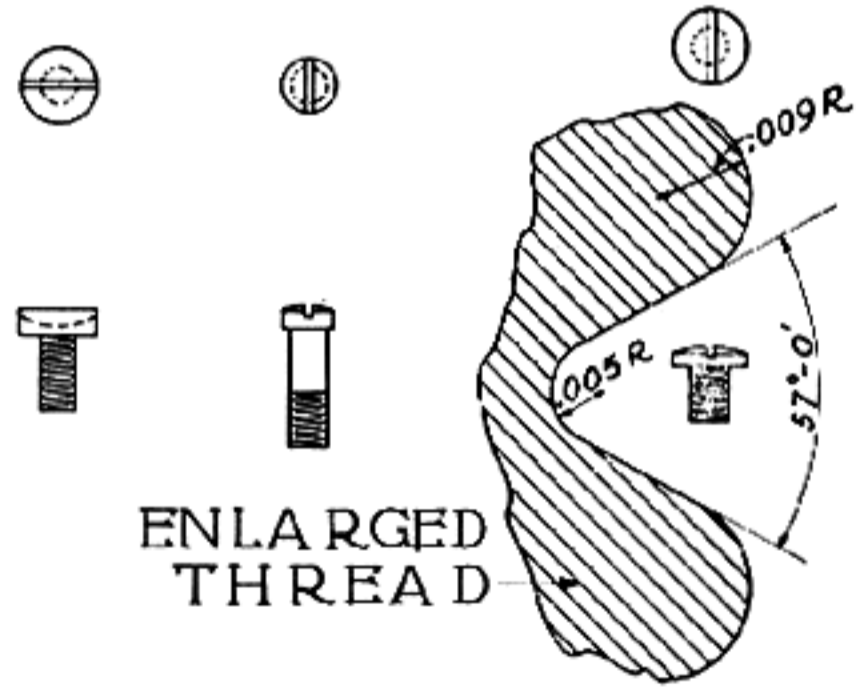

Fig. 20
Straight-edge for checking pitch of rifles and shotguns



STANDARD SCREW DRIVERS



STANDARD FORMS OF GUN SCREWS

HEADS OF VARIOUS DESIGNS

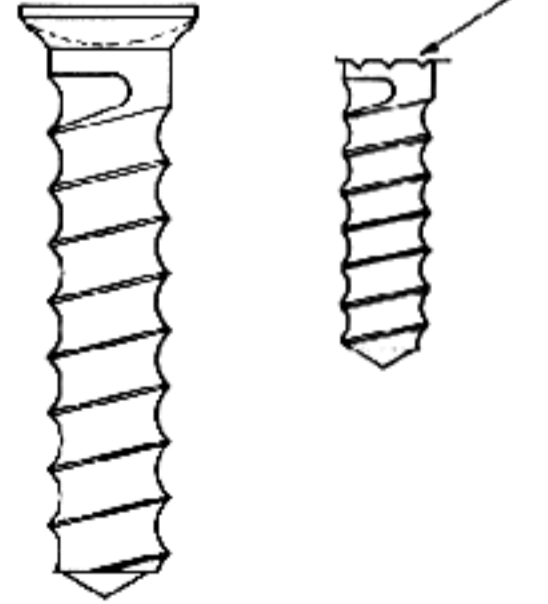

STANDARD GUN STOCK SCREWS

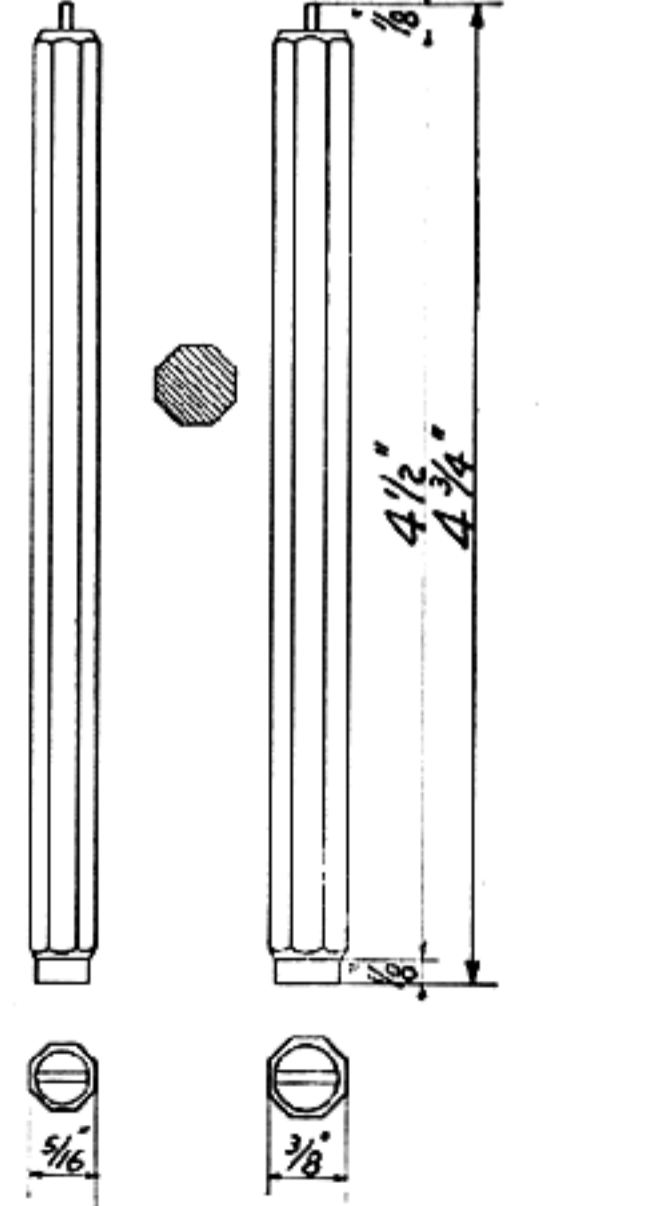

BRACE BITS

Fig. 21
Types of screw-drivers used in gun work

causes considerable spring when pressure is put on the screw, so the best is a short untapered end. When pressure is applied with the brace, the screw starts at once.

Screw-drivers of all kinds can be obtained from hardware stores, but if you buy these you will find that they are not suitable for gun work, so by all means make your own. When you become accustomed to the use of screw-driver bits you will use them at all times for the starting of all guard screws, large-size shotgun screws, and other screws. Experience will teach you to respect screws that look doubtful and that require more than the ordinary handled driver to remove.

Spring Winding Tool—This is made from an old worn ten-inch flat mill file. Chapter XXI, Volume II, is devoted to the making of springs and explains and illustrates the use of this tool.

Steel Letters and Figures—Sets of letters and figures in $\frac{1}{16}$, $\frac{3}{32}$, and $\frac{1}{8}$ inch sizes are very handy and should be included in the list of tools for stamping names and numbers on parts.

Scales (Weighing)—A trigger-testing scale is required to calculate the pull of either a revolver, pistol, shotgun or rifle. A. G. Parker of Birmingham, England, makes the best. Also include an XLCR scale which weighs from 1 to 25 pounds. This will tell you just what the weight of a fire-arm is.

Stools—One or two wooden stools made to the proper height are necessary at times when you have bench work which is done more conveniently while sitting down—such as laying-out work.

Squares—These come under the headings of combination squares, die-makers' squares, tri-squares, and solid steel squares.

(a) Combination square: Get this with two blades, one a 12-inch blade and the other a 24-inch blade. The center head and bevel protractor are also very useful in all classes of work. When certain distances are required, these heads can be clamped at any portion of the scale; the center head can then be used to find the exact center of a round bar, and the bevel protractor used to lay out or check angles.

(b) Die-maker's square: This is small, but the most useful of squares. It has four blades $2\frac{1}{2}$ inches long: a standard blade, graduated in thirty-seconds and sixty-fourths; a bevel blade with an angle of thirty and forty-five degrees; one narrow blade, and one offset blade.

(c) Try-squares: The gunsmith requires one or two of these, one small-size for checking work in small places, and the other 4 x 6 inches.

(d) Solid steel square: This is also a square for which two blades are required, one 3 x 5, and a

small knife-edge square to check work with the larger square. These tools are especially necessary in metal work.

(e) Carpenter's square: One with a six-inch blade for squaring actions and laying out stocks.

Tongs and Tweezers—These are essential and it is well to equip the forging section of the shop with:

- 1 pair $8\frac{1}{2}$ inch folding tongs
- 1 " 12 or 14 inch bent crucible tongs
- 1 " 14 or 16 inch bent crucible tongs
- 1 " 14 or 16 inch bent steel crucible tongs with ring
- 1 " 14 or 16 inch forging tongs
- 1 " disc tweezers
- 1 " hawk-bill tweezers
- 1 " three-leg tweezers
- 1 " round-pointed tweezers
- 1 " flat-pointed tweezers
- 1 " locking tweezers—to hold small screws while placing them into position
- 1 " small blunt-pointed tweezers—to pick up small screws, etc.

Templets—Templets are made when you have a considerable amount of repetition work in the production line and wish to save time in laying out certain parts, especially when more than one person works on that operation. A templet is necessary in all classes of die work before you can get the ultimate form that the die is to produce. For instance, if you were to make dies for a butt plate, the first die you would make would be the forming die to produce the proper length, width, and form you wish the plate to assume. You would then make the necessary try-outs on your forming die until you had the correct form. From each piece you file out you would scribe off the outlines on another piece of metal until you have the perfect form. This would be filed out and used as a templet to make the blanking die. In certain operations on gun work, small templets are made to serve as depth gauges, radius gauges, and odd forms where measurements cannot be made. Templets are made from thin steel or spring brass stock on which it is easy to follow the lines. These will be shown and their use described in other chapters.

Utility Electric Motor—This is a handy and inexpensive motor for small polishing work. It will also be useful in driving small Millers Falls polishing heads.

V-Blocks—A set of these is very necessary in gun work and plays an important part in a hundred and one different ways. Both Starrett and Brown & Sharpe list these in their catalogs.

Vise—A workshop is not complete without a good vise, and you should have the best. It must be of the swivel type and have $3\frac{1}{2}$ or 4 inch jaws. The Reed vise costs about \$17 and is excellent. The Penn, #524, 4-inch vise, swivel base, is also

good and a little less expensive. Also secure a Yankee Drill Press vise #990. This will hold only small parts, but it has a V-notch in the back of the jaw to hold round stock, and the movable jaw has a swivel plate to take tapered work. You will also find in working on small metal parts such as sight blades, shotgun triggers, small springs, etc., that it is possible to clamp this vise in your large vise and then work on small metal parts much more conveniently. Also secure a Jacobs #1 drill chuck, having the shank turned straight, as this holds all small round pins and screws from $\frac{1}{32}$ up to $\frac{1}{4}$ inch, and is handier than the advertised pin vises which are required in various sizes to hold the different sizes of round stock that you will work on. These are all the vises you will need in the beginning, but you will find that as your work increases you will necessarily add others.

Vise Jaws—The jaws of a vise are roughly checkered and tempered, and if you were to hold a piece of finished work in them, the impression of the jaws would disfigure it; so it is necessary to make up false jaws, such as vise blocks, lead jaws, copper jaws, and leather-faced jaws. Figure 22 shows the different jaws necessary for both wood and metal.

Other vise clamps may be made of pieces of old leather belt upon which a little beeswax has been spread. These, when placed between the jaws and forced together, will adhere to the vise. A very handy fixture can be made from a barrel stave or thin piece of gum wood by cutting out the center for the beam of the vise to straddle, letting it extend from five to six inches. Make two tapered pieces for the ends and either nail together or place a $\frac{1}{4}$ -inch machine screw through to hold together and tighten; glue thin pieces of leather to the face. This false jaw then has enough spring to release as the vise is opened.

Also make two sets of vise-blocks and glue from $\frac{1}{4}$ to $\frac{1}{2}$ -inch white felt to face of the wood. These are for barrel and stock work, as the soft felt absolutely protects the finished parts and prevents a finished barrel or stock from being marred, and yet the vise can be tightened sufficiently to hold while working. Also have a pair of false jaws made from cast brass and drill indentations to various depths to hold screws or rods without marring them. Wooden jaws should also be made to hold odd-shaped parts such as are found on shotguns. As time advances you will find a large collection of the wooden jaws on hand, and will have gained

considerable experience in holding work properly in a vise.

Welding Outfit—This comes under welding and brazing, which are discussed in Chapter XXVI.

Wrenches—Old percussion-lock guns which have a nipple require a nipple wrench, so if you are a lover of these it will be well to have this type of wrench on hand. Also have a 15-inch Crescent wrench to remove barrels and tighten them into receivers.

This list of tools has not been compiled from conjecture or from a hardware catalog, but from an actual list of tools used during the course of many years' work on firearms and general shotgun practise, including gauge making, tool making, die making, instrument making, etc. To the beginner this list may seem extraordinarily long, and a discouraged attitude on his part may result, for he may not realize what a great part even some of the simple tools will play. The advanced student, on the other hand, may think there are several important tools lacking, but as he progresses into Volume II the mechanical art of tools will be explained more extensively.

I do not expect the beginner to buy all the tools on this list at one time; on the contrary, I would suggest that he secure only the work bench and vise. Decide upon just what you want to do and the tools required for that particular project. Then make an effort to acquaint yourself with the tools. Read over this chapter until you are thoroughly familiar with it, and obtain a number of the catalogs listed in the Directory; this will give you a general idea of the expense to be encountered in the layout. By all means do not attempt your first work upon some finished arm, but invest in some of the old firearms in Francis Bannerman's catalog at prices from \$1.50 to \$5.00, or even upon some simple piece of wood.

The novice has a tendency to jump into a new hobby with such enthusiasm that he is ready to buy anything and everything pertaining to it. This is, however, most unwise, inasmuch as one is apt to purchase many tools that will prove of little or no value later on. In considering the use of wood-working tools we must form ideas and study their purpose with reasonable judgment, so naturally it is best to purchase these as needed and advance with some definite plan in mind to greater needs and additional tools as necessary, so that our financial resources will not suffer.

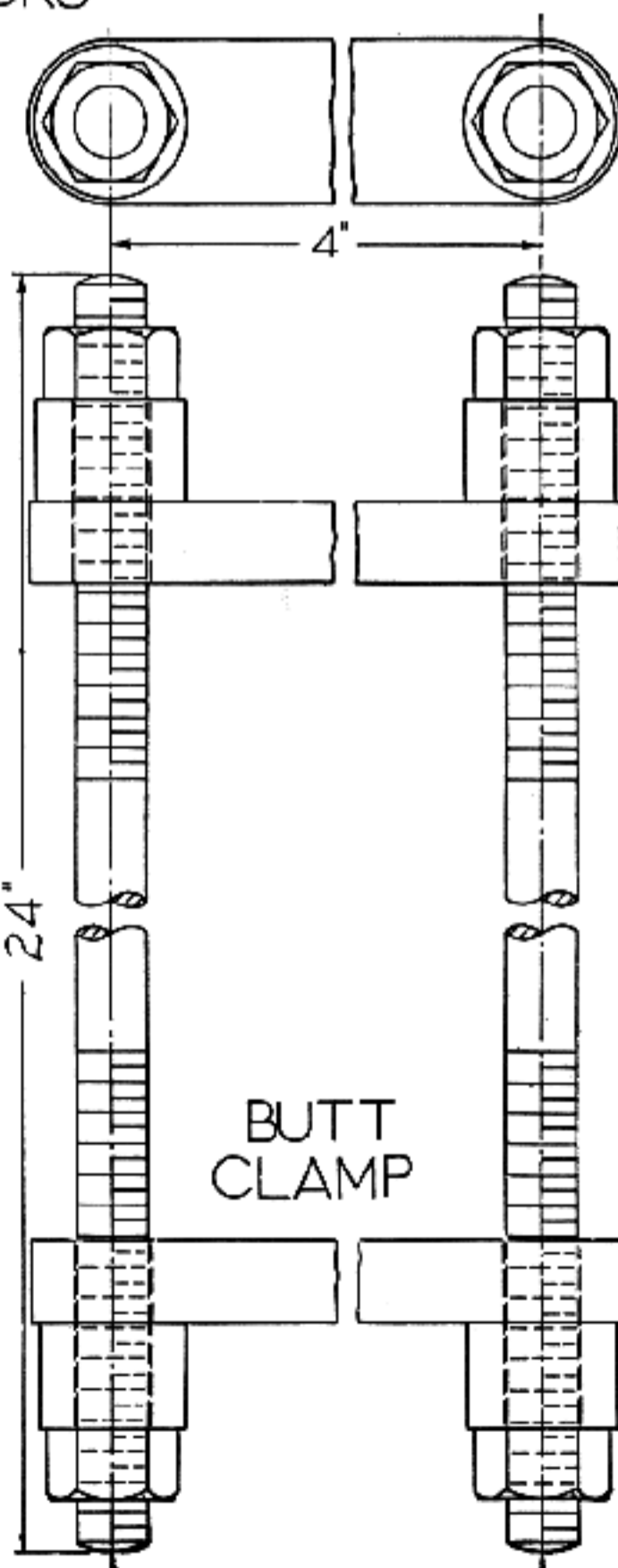
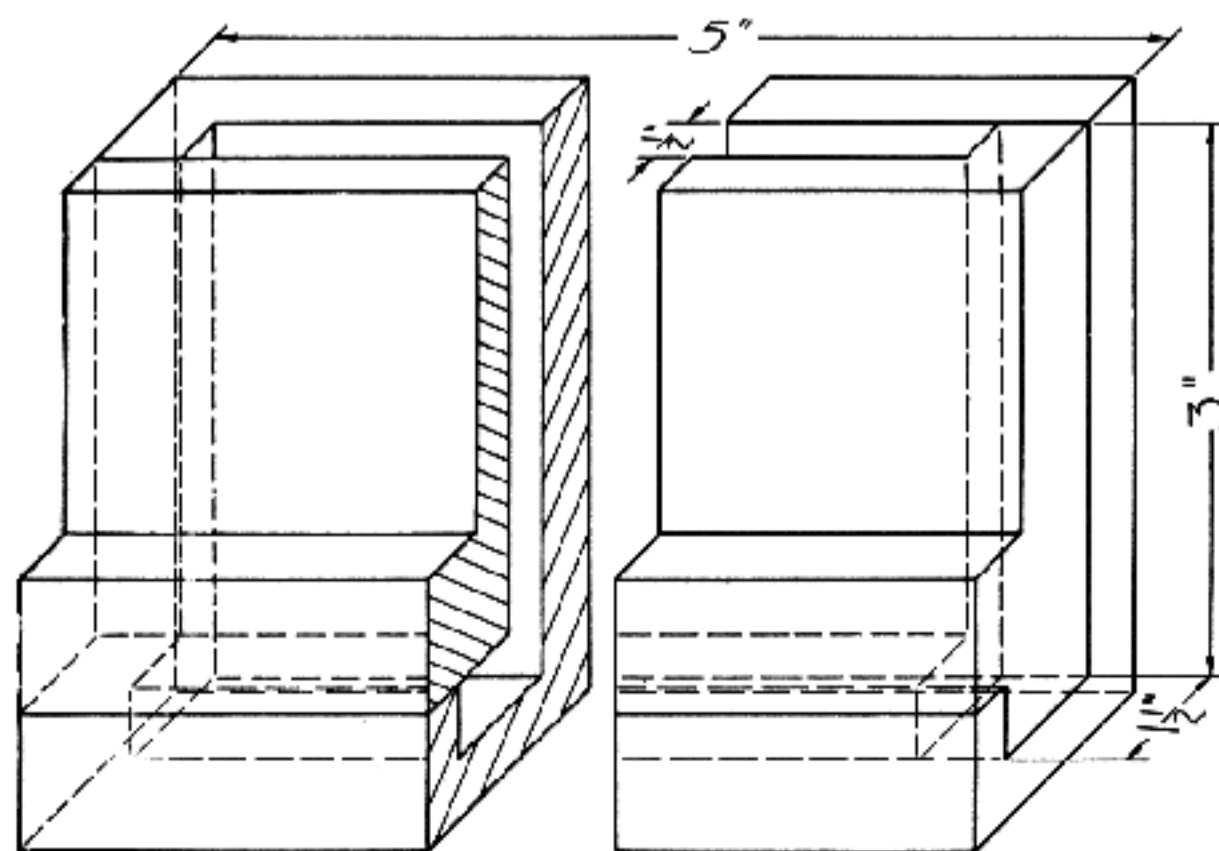
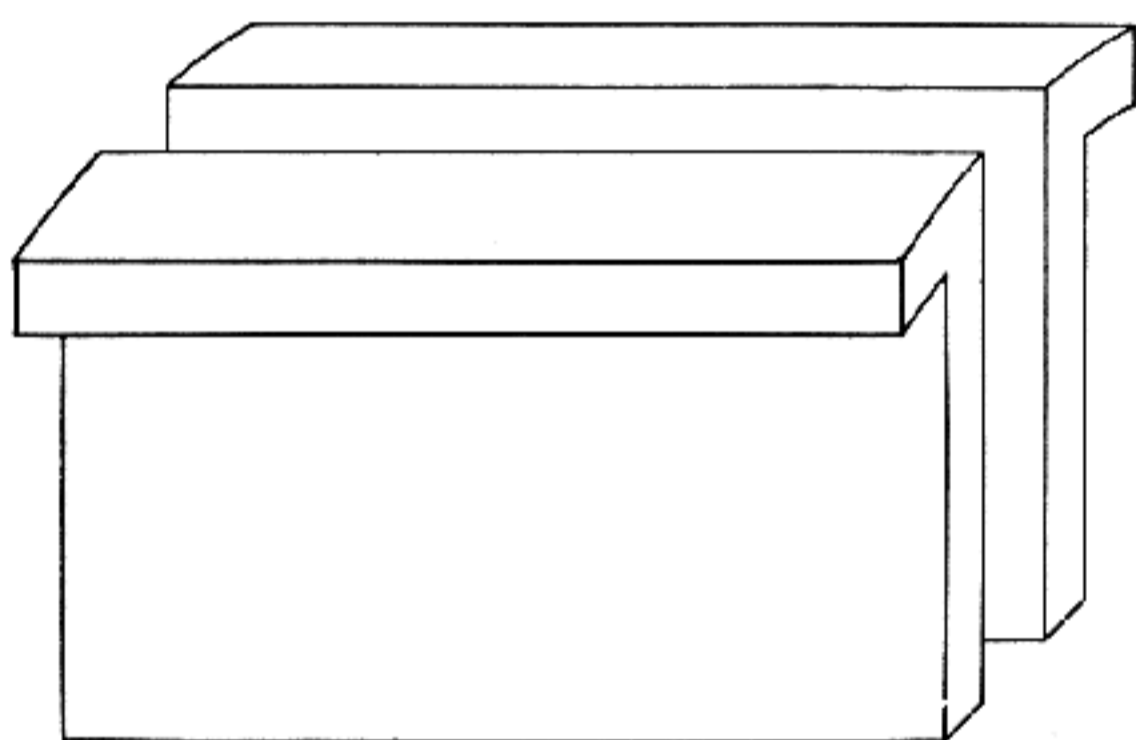
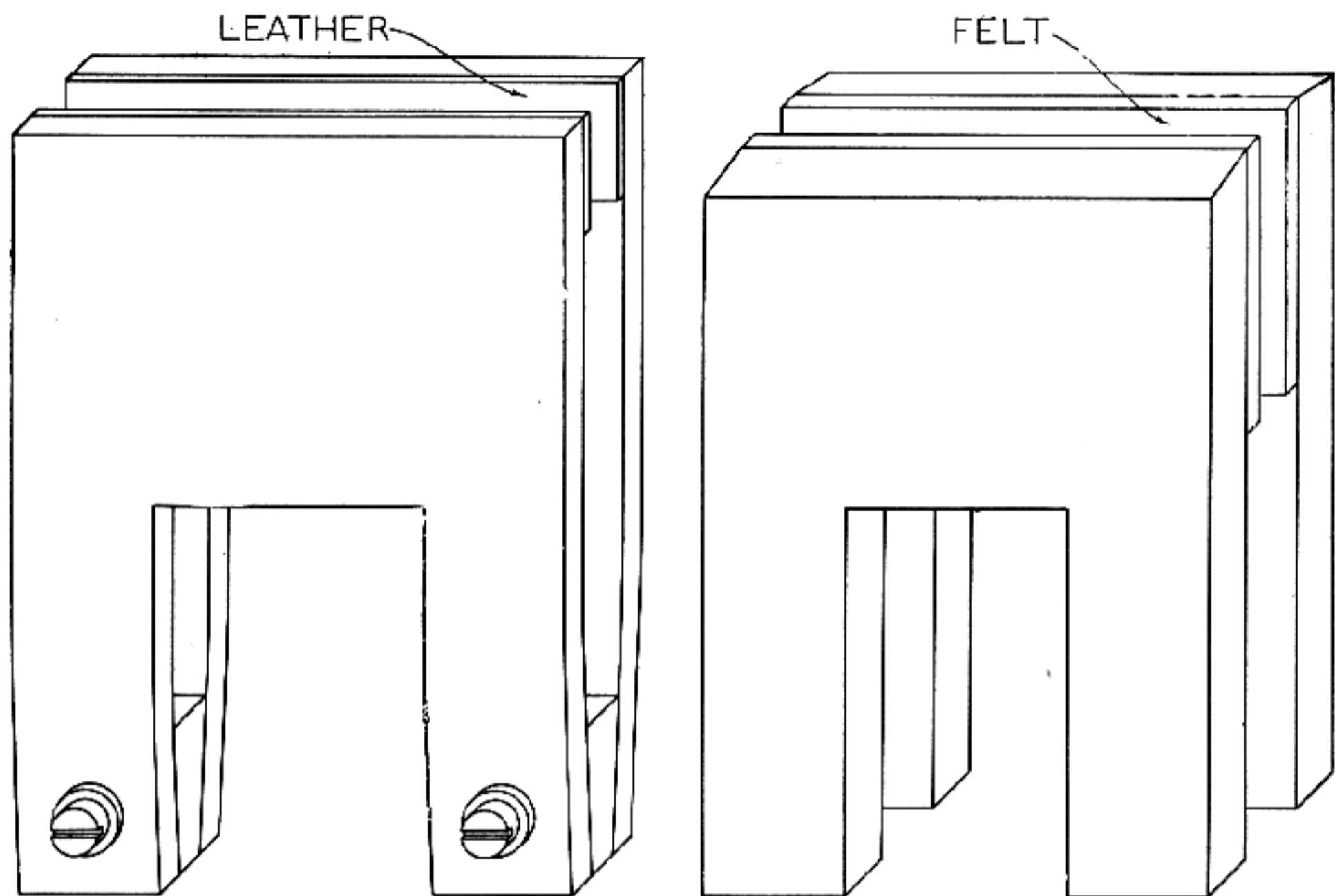
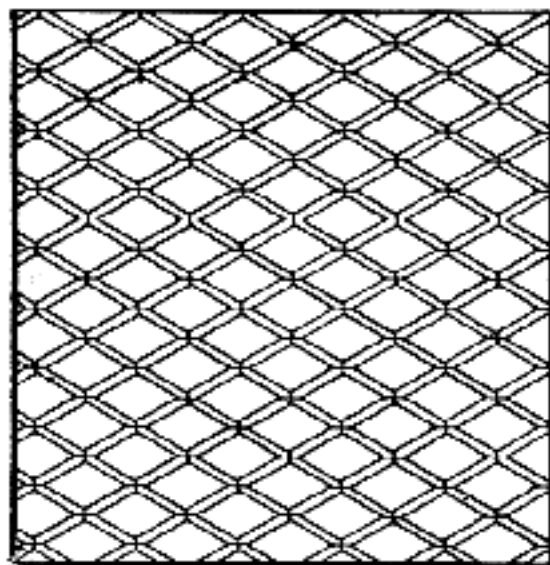

Fig. 22

Bench-vise blocks commonly used in the gun shop. The butt clamp is employed when fitting shot-guns or single-shot actions into the stock blank

CHAPTER II

Special Home-made Tools and Equipment



Special Home-made Tools and Equipment

THE gunsmith, to be able to carry out all work successfully, must construct various special tools or fixtures and purchase others if he is to make this work a pleasurable and profitable means of spending what might otherwise be idle hours. Man is known as the "tool-using animal," but how many of us can use our hands to advantage to create articles for our own needs? Your schooling has taught you to do things in certain ways and by certain rules, but at times these teachings must be thrown aside and you must turn to originality and create the part suited for the occasion. This chapter is designed to enable the beginner to carry out the most essential undertakings; after having set a place aside for a workshop and getting together some of the most necessary tools, other equipment will be explained as each need arises.

The trade of a gunsmith, shotgun or rifle maker calls for many tools which cannot be purchased, and when manufactured by an outside concern these usually cost far more than if made by yourself. Do not construct a number of makeshift contrivances, using a nail here, a piece of wire there, and so on,

even tho an enforced makeshift is required in many instances. These are often only steps toward new labor-saving devices; but discard the makeshift as soon as possible and construct one which will be a credit to your ingenuity—and do so before anyone can accuse you of being shiftless. A gunmaker is constantly making devices for his different needs as they present themselves, and if the information contained in these chapters is carefully studied many of your problems will be reduced to a minimum.

Chapter I contains a thorough description of various tools. This chapter will deal with our tool problems a little differently, and will consider a few that are non-essential but can not be dispensed with conveniently.

Checkering Stand and Cradle — Figure 23 illustrates a checkering stand which, for the present, we shall class among the non-essentials. A checkering cradle can be fastened to the end of a bench, used, and then removed and put away until it is needed again. But if a well organized workshop is

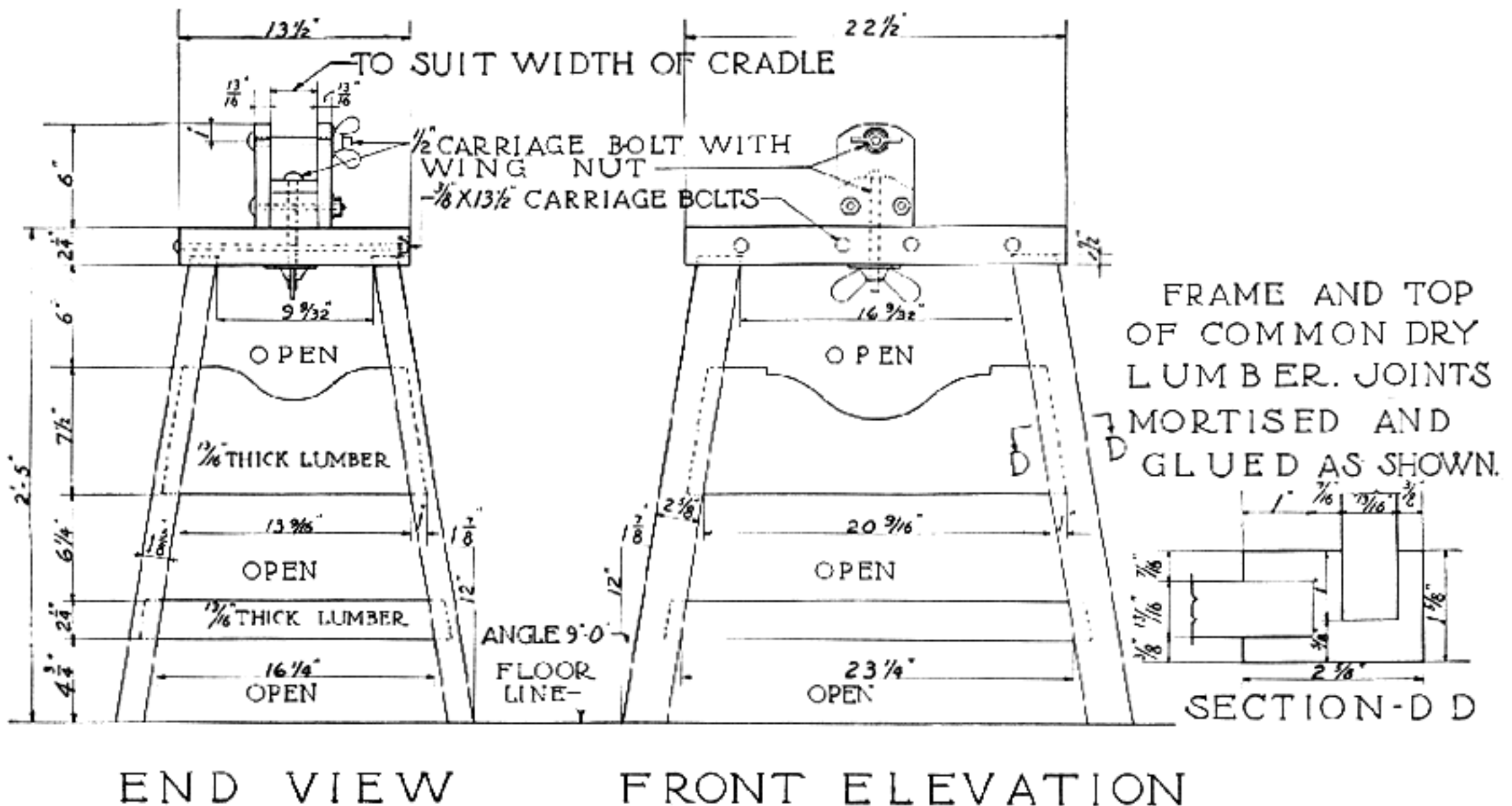

Fig. 23
Bench or stand for checkering cradle

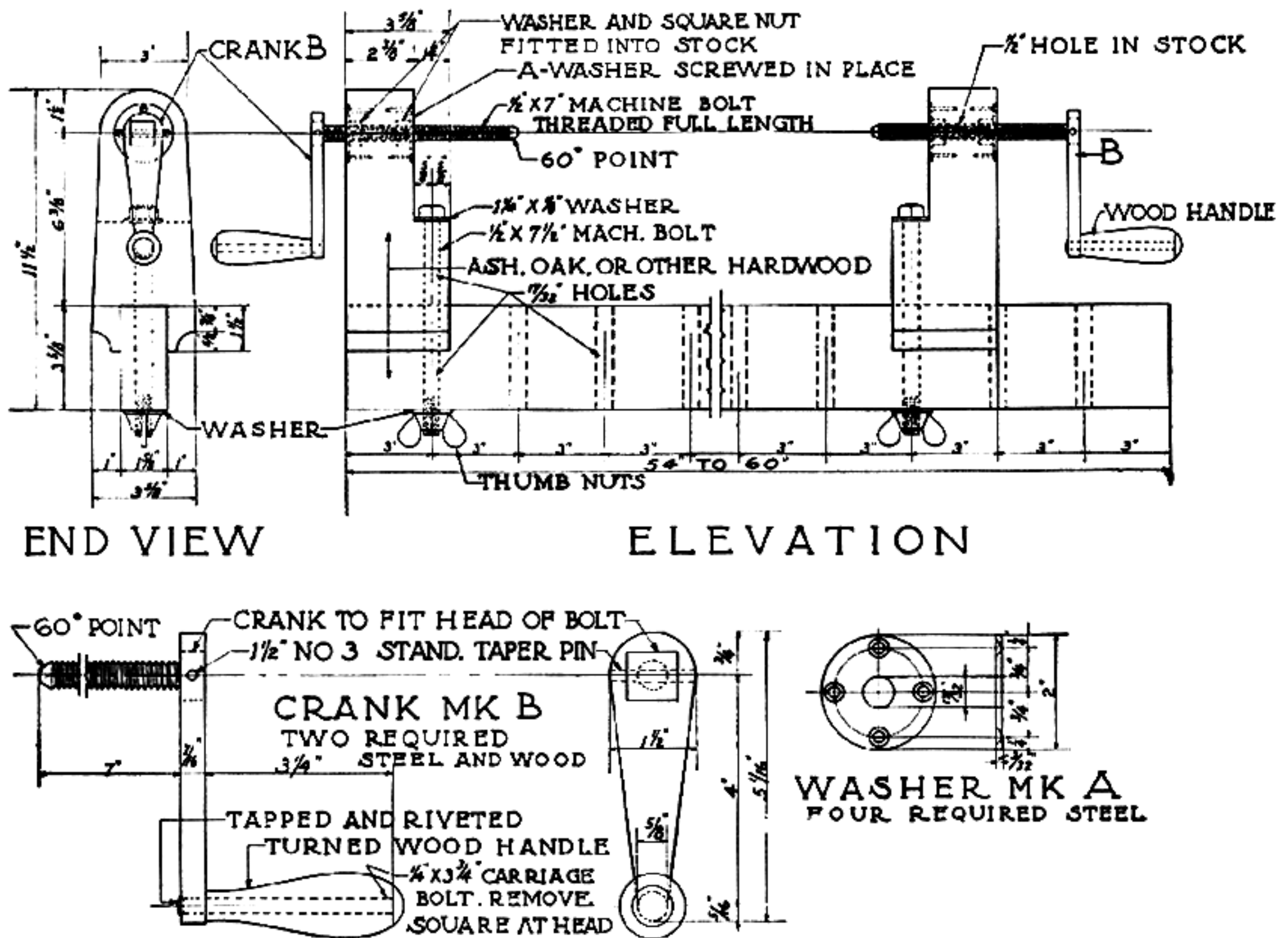

Fig. 25
Improved checkering cradle for the amateur

cradle is clamped by the cross bolt. Even when the holder is made of angle iron, a two-inch width of cradle may still be used instead of the heavy member shown in the illustration. The angle brackets *A* can be bent from $\frac{5}{8} \times \frac{3}{4}$ inch cold-drawn steel, and as there is a tapped and a plain drilled hole on each end of the bracket, these may be reversed when a longer stock is encountered, thus providing a greater length between centers.

Figure 25 shows a simple form of cradle on the same principle as the first one. In the following chapters many uses for the checkering cradle will be indicated, and you will discover others for yourself. These forms are offered here to suggest to the beginner what may be done, not only in designing a cradle, but in devising other aids to accuracy and the simplification of difficult work.

Checkering Tools—After studying Figure 3 you will see that there are a number of ways in which checkering tools can be made. One of the best tools to construct is the one shown with separate cutters which screw together; with this it is

possible to sharpen the inside cutting edge as well as the outside.

They can also be adjusted to any desired width or spacing. Our present checkering tools only cut with the outer teeth. These are easy to make, and produce an exceptionally fine checkering pattern, but when two separate blades are made and screwed together we have one of the best checkering tools that can be constructed.

Border tools can be made in a V form, radii, V and radii, or on an angle. Generally these tools are only for experimental purposes, for the best checkering has no border at all; and after you have become expert, you will find that you can reach the lay-out lines without any run-overs, and the border tools will be laid aside.

The English type of checkering tools shown in the same illustration are excellent. They are usually made with the single cut, and after one becomes accustomed to them very good work can be produced. Examine the checkering on a fine British gun and you will see that the diamonds are perfect and sharp. Such checkering was produced by one

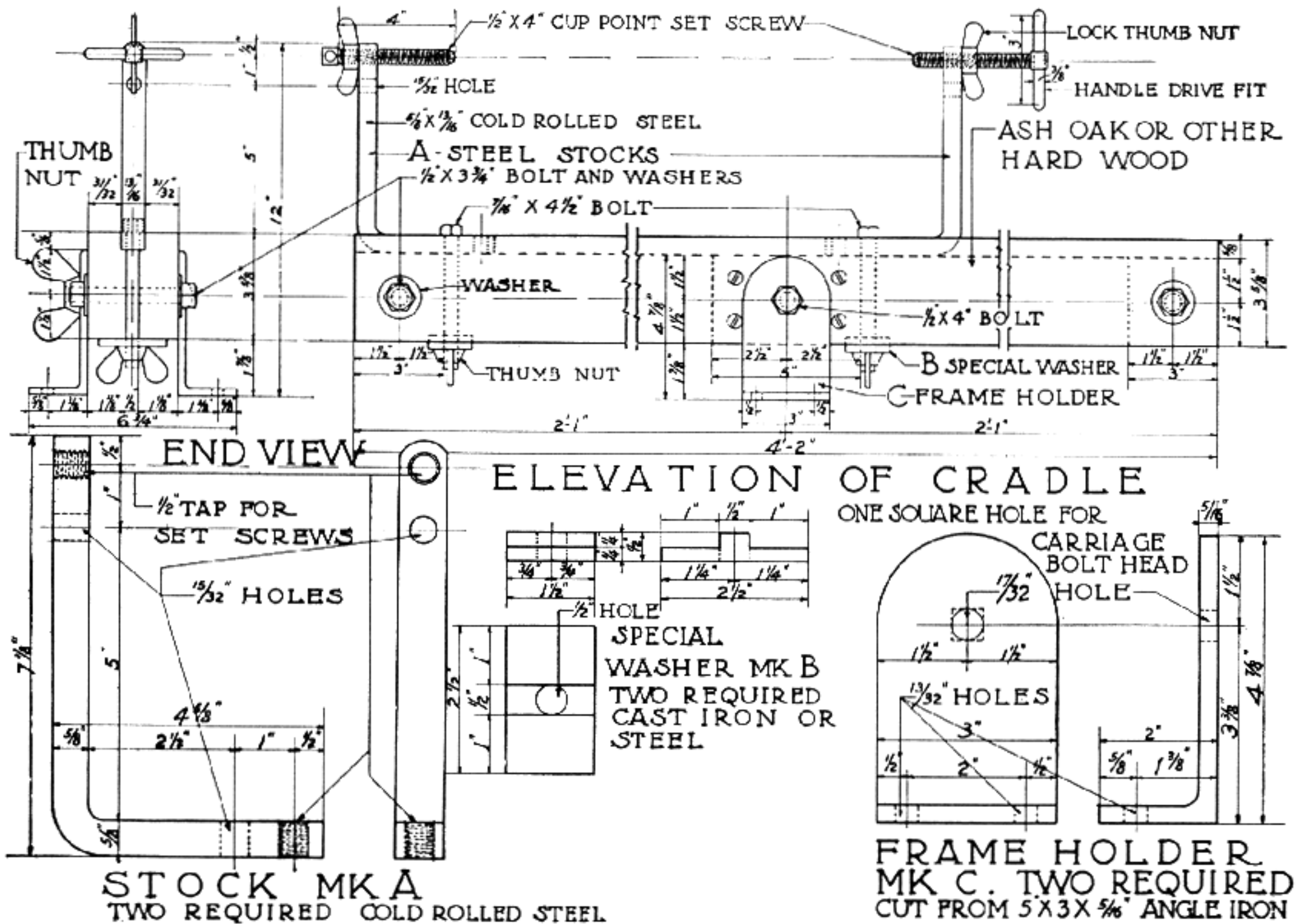

Fig. 26

Checkering cradle most generally used in the gun shop

of these tools. In the end, after summing up the merits of different checkering tools, you will find these the best.

Motor Grinders — These are among the most essential parts of any shop where mechanical work is performed, for they are called upon more times throughout the day than any other machine. The beginner should manage, if possible, to have some kind of a grinder, even if nothing better is available than an electric fan motor. Small cloth, leather, felt, and wooden discs with sandpaper attached are almost indispensable at times. Any investment you make in this equipment will pay for itself many times. There are many electric motor grinders on the market costing from \$30 up. It is impossible to list them all, but a good selection may be obtained from machinery-supply or mail-order-house catalogs. Figure 27 illustrates a Black & Decker bench grinder.

All these small reasonable-priced grinders carry two emery wheels and are usually of the ball-bearing type; one emery wheel can be removed and this side used for polishing and buffing. These grinders are small and compact and may be conveniently

placed on the end of the bench. At an additional cost, they are furnished with cast-iron floor pedestals; these are usually preferred, as they leave the end of the bench free and clear for other purposes. On all the small grinders, the shafts are 1/2 inch in diameter; therefore, all holes in the polish-

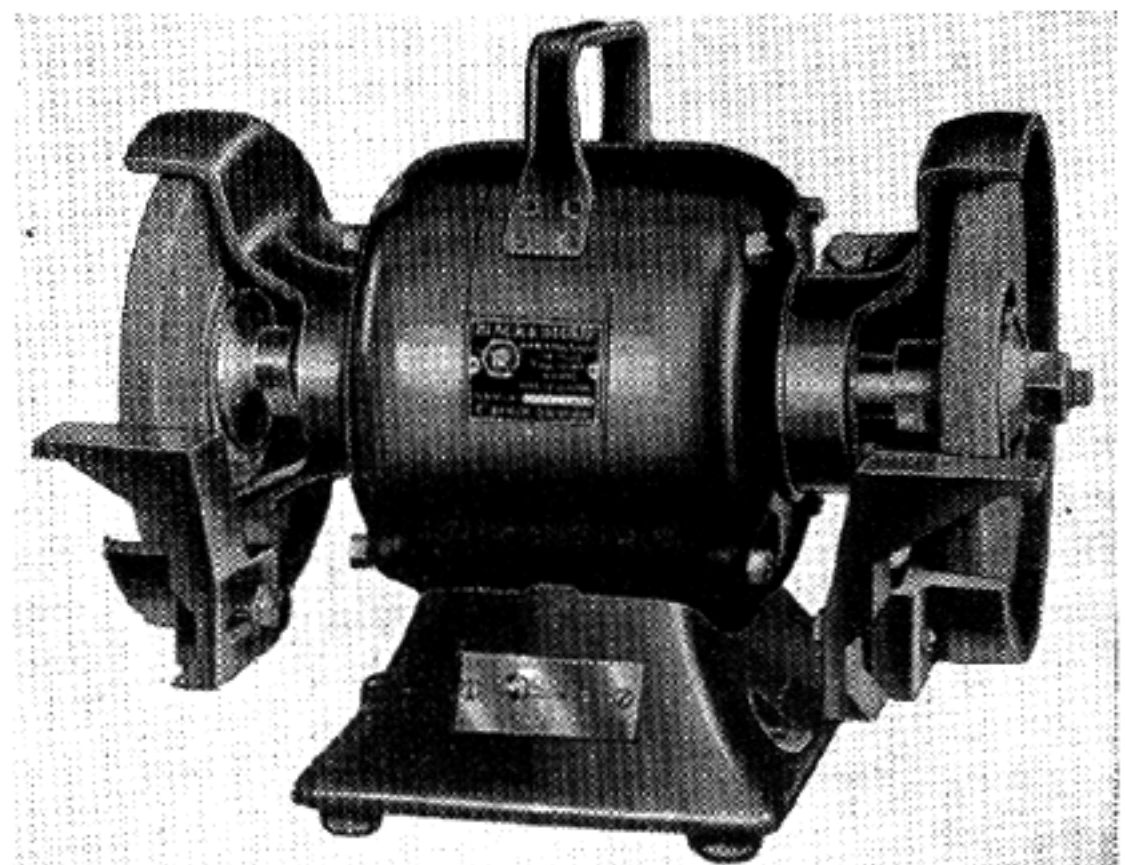

Fig. 27

A portable bench grinder is indispensable in the small gun shop

ing wheels or discs must be of this size and a free but perfect fit, or too much vibration will result. The grinders are equipped with movable guards and a tool rest, which can be conveniently adjusted to heights; on some it is possible to get various short angles. With the emery wheels removed, it is possible to use wire or cloth buffers and sandpaper discs for dressing rubber recoil pads. Various uses for the grinder will continually occur. By using different-shaped emery wheels with thin, rounded, or bevel edges, it is possible to grind out places on hardened parts which would ordinarily require annealing and the use of a file.

Fine circular steel wire wheels are the secret of all fine bluing on firearms; they not only card off rust during the bluing process, but also burnish the barrel. A fine wire buffing wheel should be used only for the bluing operation; when first purchased it should be boiled in strong lye water to remove all traces of grease, and then rinsed in clean boiling water. Should the fine wire show evidence of rust, it indicates that there is no grease or oil on it to spoil the bluing. Other fine wire wheels should be used to remove rust from gun parts and to burnish nickel-plated revolvers. It is surprising how one of these wheels will clean up a spotted barrel when small rust spots have formed, particularly on fine shotgun barrels.

Muslin buffing wheels are also required on the grinder. The 8" diameter is used for polishing. The sewn wheels are classed as "hard" and the unsewn as "soft." Keep a number of these wheels on hand, as well as the different polishing compounds, such as Tripoli, rouge, Vienna lime, emery paste, etc. Others may be surfaced with fine emery for the breaking-down process before the other compounds are used for a final polished surface.

Wooden wheels should be made from hardwoods such as maple, cherry, or beech. Scribe a circle of the desired size, and with the $\frac{1}{2}$ -inch wood bit, bore out the center for the shaft, and saw the outside of the circle. Clamp it on the shaft and true the outside with a regular turning chisel. A rest must be provided so that the chisel can be handled more conveniently and will not catch in the wood, thereby causing a painful injury.

Coat the sides of these discs with glue or shellac and apply different grades of sandpaper or emery cloth, clamping them in place with other boards or discs, and allow to remain until completely dry. The outside edges are then trimmed off to the outside diameter of the wood. These are used when a flat surface is to be polished; with the coarser sandpaper disc, the rubber recoil pads are dressed to the outside contour of the stock.

Special wheels of felt make the finest wheels for polishing purposes. They may be used with fine abrasive glued to the outside surface or used with emery paste, rouge, or Tripoli. Very fine polishing wheels are also made from rubber, leather, etc. The leather wheels are used for various shapes and forms after being turned in a lathe.

Another useful accessory is a chuck made so that it can be screwed or slipped on the end of the grinder spindle and then fastened by a headless screw. This arrangement is used to polish small pins and to file a number of pins and screws. A small firing pin or a bead for a sight can be made in this manner. A successful lapping operation can also be accomplished by holding the lap in the chuck and holding the work in your hands.

There are various wood laps which can be made: square-faced, pointed, round, oval, etc. They are also made small in small sizes to polish the inside of metal parts, such as trigger guards, where it is rather difficult to reach with any other form of polishing wheels. These are made in a cone shape and screw on the end of the spindles; they should project between two to four inches from the end. Wooden laps made from hard or soft wood are used for polishing steel or any other form of metal and general lapwork. The substances used on these laps are oil and flour emery, Vienna lime, rouge, rottenstone, tripoli, etc.

Wood Chisels — Often these can be made from worn files which have been discarded from machine shops; special wood chisels can be forged from high-carbon tool steel, and even made from worn power hack-saw blades. At times the beginner will do much better to forge all the special chisels required for the stock-making operations and in the end will find it much cheaper than purchasing them. Of course, you must buy some chisels, but the ones you make will be more prized. A study of your needs should determine your purchases; for instance, the most-used flat chisels are the narrow ones; therefore, purchase $\frac{1}{8}$, $\frac{1}{4}$, $\frac{3}{8}$, $\frac{1}{2}$, $\frac{3}{4}$ inch tool steel in 12-inch lengths.

Tangs are forged on these, and one piece will make two chisels, the shorter ones are sometimes required; but when forging a chisel for wood working, always make two. I am a great believer in pairs of tools, for when one becomes dull or an accident occurs, there is always the second one to fall back on. After the tangs are forged, dress the ends by heating and forging the cutting portion so that there will be less grinding to be done; this also gives the steel a more harmonious structure and a finer grain.

Gouges — The half-round or radius gouges are made from drill rod; the diameters used are $\frac{7}{8}$, $\frac{3}{16}$, $\frac{1}{4}$, $\frac{5}{16}$, $\frac{3}{8}$, $\frac{7}{16}$, and $\frac{1}{2}$ inch. If there should be a shaper or a milling machine in the locality—or a friend who is a machinist—they can be milled or shaped and the ends turned, as illustrated by Figure 5. Of course, the cutting end is also forged to nearly half its diameter and then filed; but since the tangs must be turned, a machine operation is the most accurate means of holding the true radius of the rod used. After the end is shaped to half its diameter on an angle, the cutting edge is filed to a true sharp point, only leaving enough metal to stone after the hardening operation is performed. A set of such gouges is indispensable in wood working, particularly when making a new stock.

Bottoming Chisels — These tools can not be purchased, so they must be made by the student. The ordinary carving or small straight chisels are not adapted to many operations, especially the inletting of shotgun actions into stocks. Bottoming tools are made from $\frac{3}{16} \times \frac{5}{16}$ -inch tool steel, forged and filed to shape. Figure 28 illustrates the forms most used to meet requirements. These are

forging operation is completed and the tang is drawn out, the cutting edges are filed to shape.

All wood-working tools named here should be given very careful heat-treatment so that they will maintain their keen cutting edges. After the hardening operation, the tools are polished and the temper drawn to a purple; then the edges are stoned to a keen cutting edge with fine oilstone, finished with two fine Arkansas oilstones, and then stropped.

Handles must also be provided, and can be made from straight-grained maple. They are either turned or formed in the shape of a square, similar to the old-fashioned handles made by old-time cabinet makers. These handles are very simple to make and give the beginner practise with wood-working tools that have been supplied for the shop. Ferrules must be purchased for the ends; the heavy steel ferrules are best and are sold by almost all large supply houses. Avoid the thin brass ferrules seen on cheaper tools. To remove the plain appearance of the bright steel, polish and give a case-hardening treatment with color. (See Chapter XVI, Volume II.) This treatment not only gives the ferrules a pleasing color but protects them from

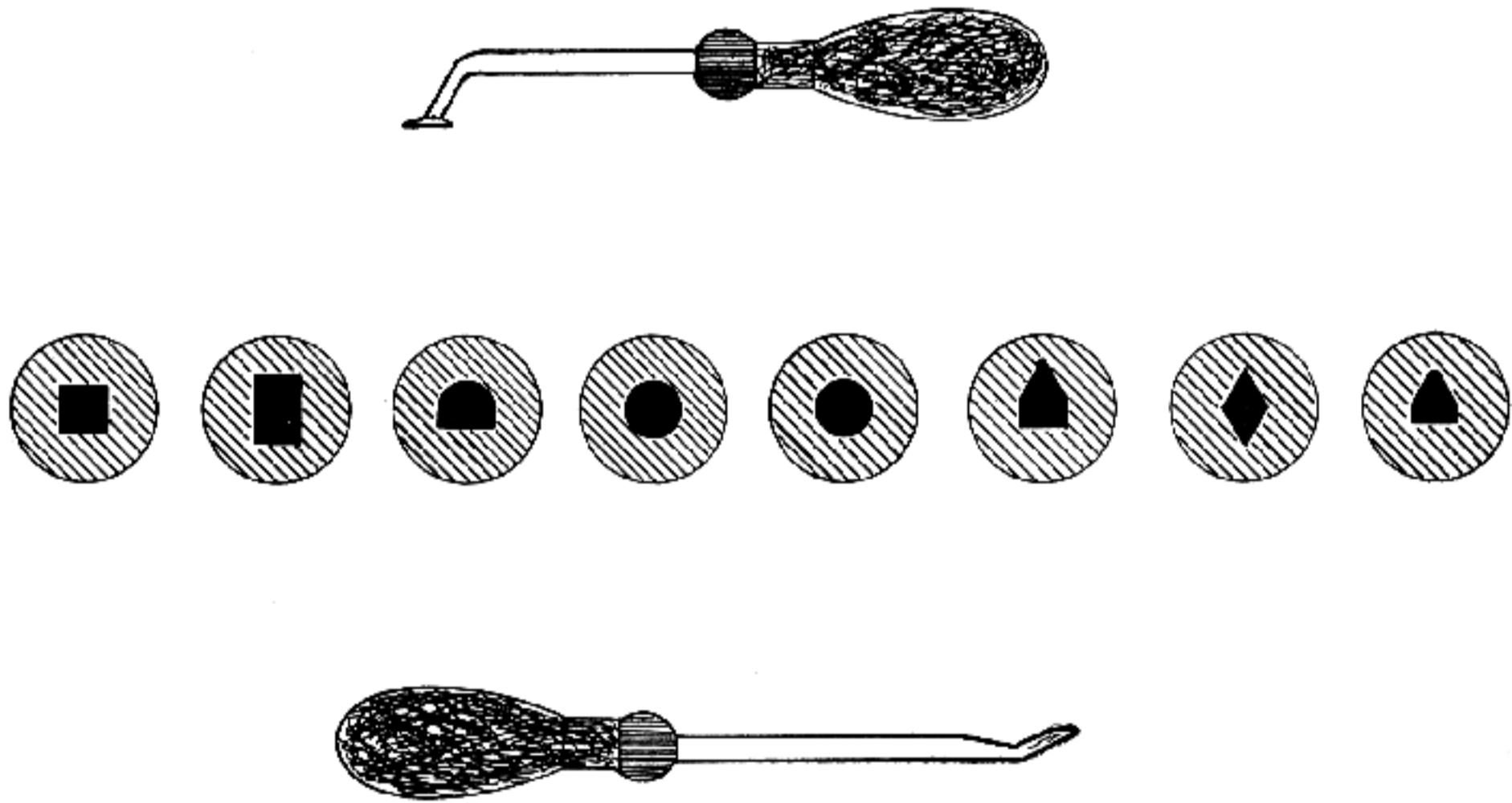

Fig. 28
Bottoming tools

made to suit the particular job you may be working on. This is the best way to make all such tools, as you can then better appreciate their value. In forging these tools, constant heat is required throughout the operation, or checks will develop in the hardening. Shaping of the end is an upsetting operation, and this is best done in a vise with the flame of a gasoline torch, holding the steel rod while the upsetting takes place. After the

the rust caused by perspiring hands or salt air.

Screw-drivers — These tools are of the greatest importance to the gunmaker, for you can never have a set of drivers too well made; and even if you should make every known size, you will still find a screw slot that the ends will not fit. Figure 21 illustrates these, and a set of three handles of the best design for the gunmaker's use. The steel

used is the finest octagon or hexagon chisel steel, forged, ground, hardened, and tempered. In the same illustration are given the sizes of the brass ferrules used on the end of the handles. After the drivers are driven into the handles, a $\frac{1}{16}$ -inch hole is drilled through the ferrule and driver, and a piece of $\frac{1}{16}$ -inch drill rod is driven in, riveted over, and filed flush. This illustration also shows the auger-brace drivers which are used to remove screws that cannot be started by the hand screw-driver. Since the points are made close to the body of the steel, there is no spring to them, and when placed in the brace a tremendous amount of turning force can be placed on a screw. This driver will remove the tightest screw.

Most manufactured screw-drivers on the market have a wedge effect on the point. When such a driver is placed in screw slot and any pressure is applied, the wedge part of the point has a tendency to back out of the slot and mar the head of the screw very badly. You will notice that the ends of the drivers illustrated are perfectly straight for some distance. For this reason, when such a point is inserted in a screw slot, the straight sides have perfect bearing surfaces along the two straight sides of the slot; therefore, the point of the driver will break before slipping out of the slot. Because of

the straight sides it is only necessary to regrind the end straight across. These should be oil-hardened and the temper drawn to a blue very gradually. The employment of a lead bath for the hardening, and an oil or niter bath for the tempering, produces the best results; and when completed, the end which is inserted into the handle is drawn over a Bunsen burner so that a hole may be drilled for the keeper pin. The hole bored in the end of the handle is of the same diameter as the flat side of the steel, so when the driver is driven into the wood it cuts its form into the hole; therefore, no radius or rounded surface should be given to the end of the driver; only grind off square so it can cut its way through the wood.

Gun Braces — A gun brace or bench horse is a bracket made from a heavy piece of wood which is fastened to the bench and extends over a distance to rest a gun stock on while shaping it. Figure 29 illustrates one which can be made from any scrap hardwood. The height should be made the same as the bottom of the vise jaws, so that when a stock is fastened between the jaws it will be level. The top of the brace should be padded with some soft material such as leather or felt, so that when a finely finished gun stock is rested on its surface

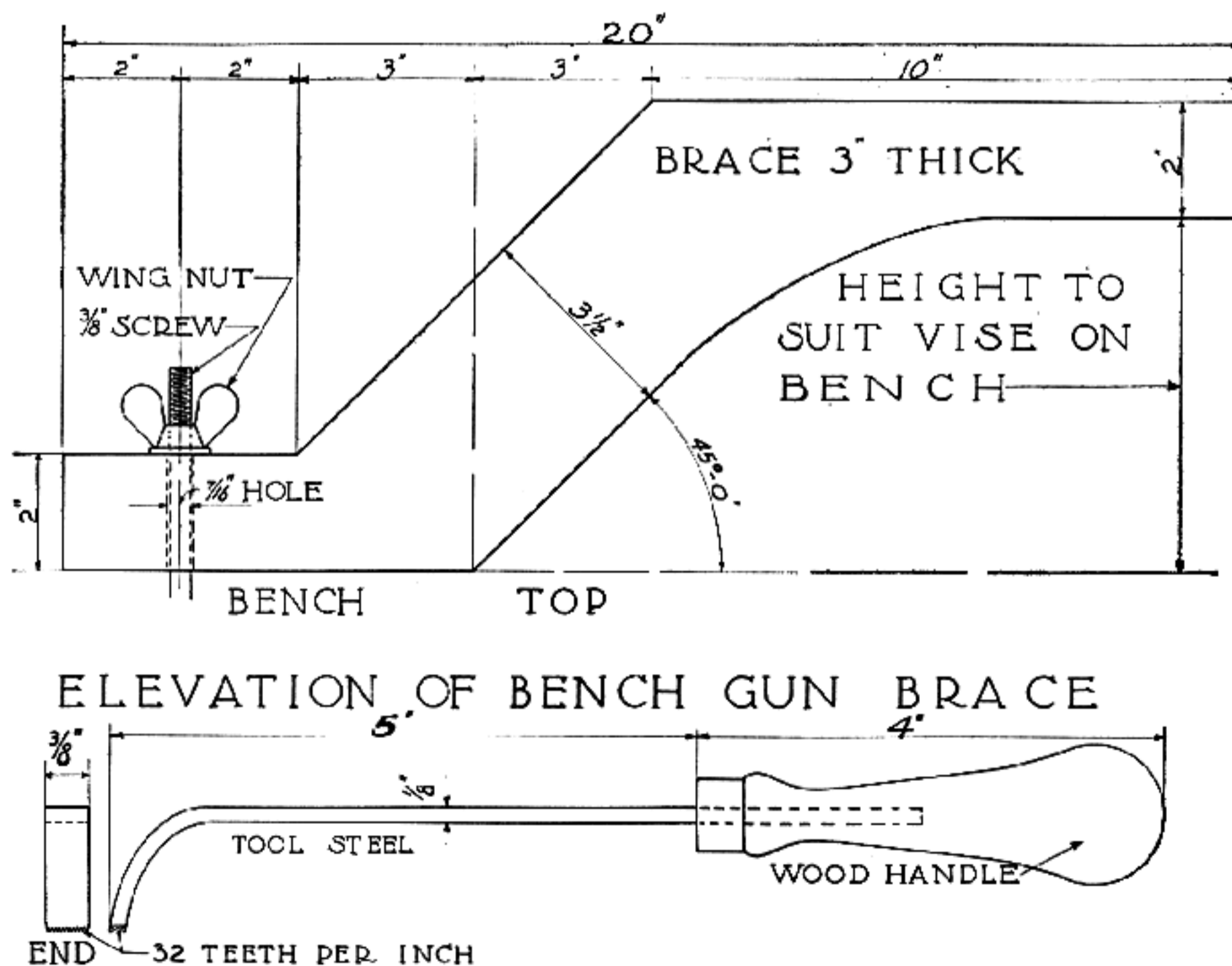

Fig. 29

Bench gun brace, frequently called bench horse. Scoring tool: Used for roughening surface of wood before gluing

there will be no danger of marring its finish. The brace is clamped to the bench with one machine screw and a wing nut so that it is possible to swing the brace in any direction at will. It is often wise to construct two of these braces, one on each side of the vise. If you should make one for the right side of the vise you will soon discover that one is needed on the left side also.

Rifle Holder—Figure 30 illustrates a rifle holder for testing purposes on the range. A device

the form above it goes over the leather to make a perfect union as it is clamped in the vise. If the student does not care to go to all this trouble, one can be made from a piece of 1 x 2 x 4-inch cold drawn steel with the form cut out on a shaper or milling machine, and a piece of leather glued and screwed into place. A $\frac{4}{16}$ -inch hole is drilled $\frac{7}{8}$ inch from the end, and a $\frac{3}{8}$ or $\frac{1}{4}$ -inch set screw is used for the clamping member. A $\frac{3}{16}$ -inch hole is drilled in the head of the screw and a piece of $\frac{3}{16}$ -inch drill rod two inches long inserted; other-

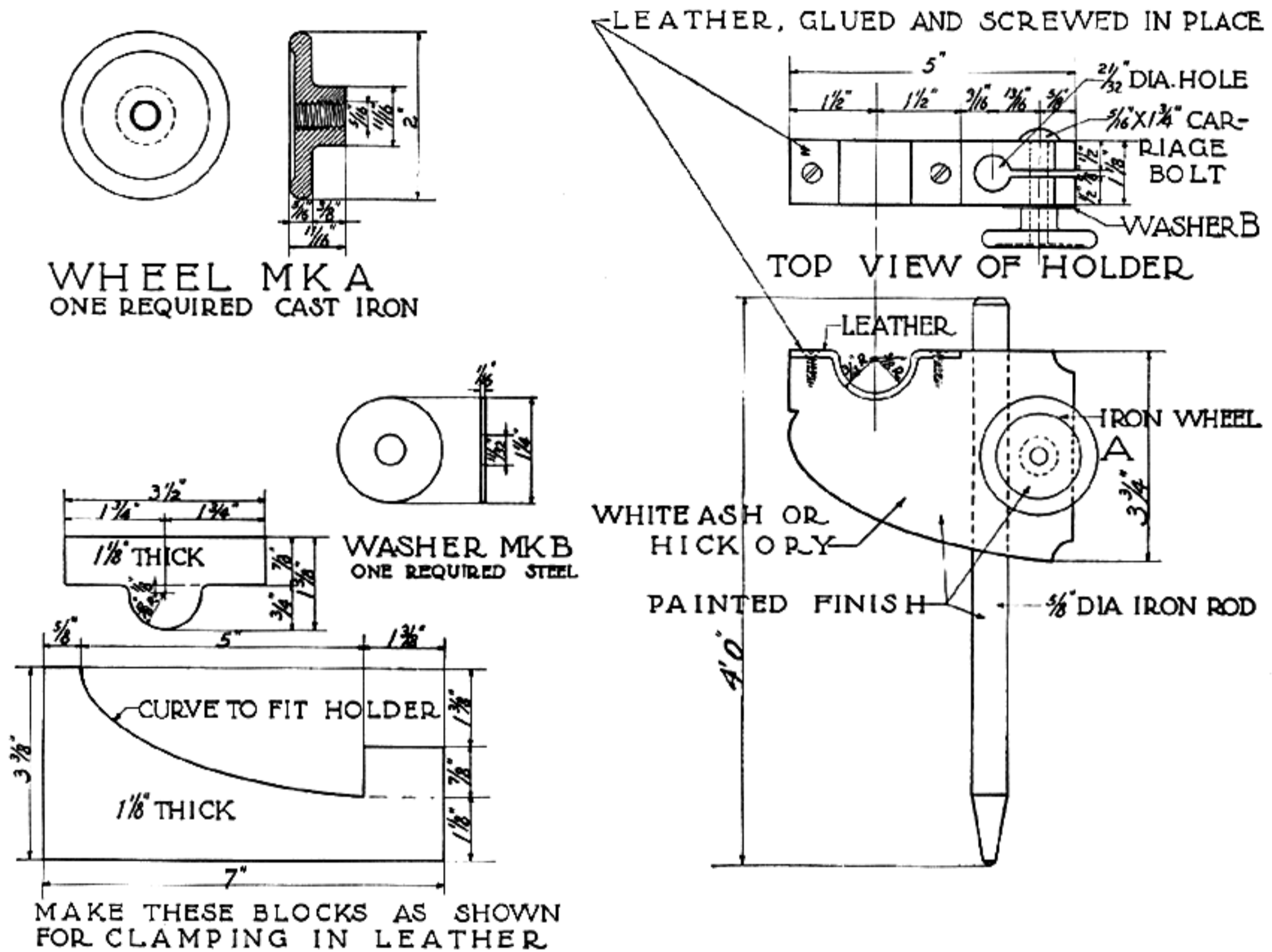

Fig. 30

Rifle holder for testing purposes

such as this is an essential part of any rifleman's equipment to test and target a rifle in the prone position. The $\frac{5}{8}$ -inch rod is made from cold drawn steel about three feet long and pointed at the end. The holder is made from a piece of hardwood with a clamping wheel on the side. The wooden block is split so that it is possible to secure a very tight clamping effect on the rod. The rifle form is cut out and a piece of leather glued in place. The form illustrated on the left-hand side of the drawing is placed on the underside of the block, and

wise a small wrench would have to be carried along. The position of the locking screw on the end of the holder makes it very convenient to reach and make any adjustment with.

Tool Holder—A tool holder to grind flat chisels, plane bits, etc., is illustrated in Figure 31. The simple construction of this holder and the explanation given on the illustration should present no difficulties for the student. It is one of the most essential tools for the amateur, as he cannot

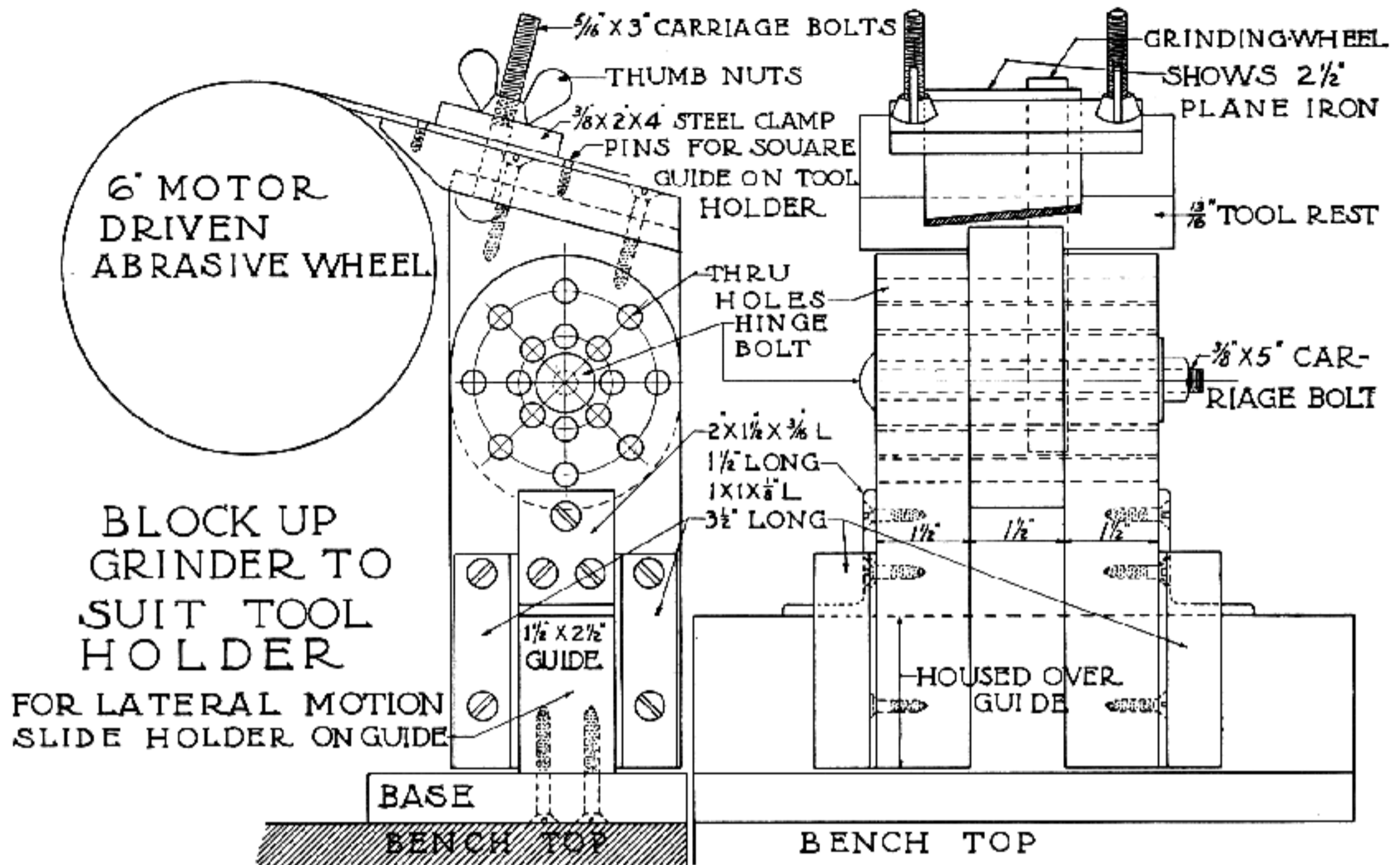

MADE OF ROCK MAPLE OR ANY HARDWOOD. BY CHANGING THE HINGE BOLT TO ANY OF THRU HOLES, VARIOUS ANGLES MAY BE OBTAINED TO SUIT MOST GRINDING JOBS. SCREW OR CLAMP BASE TO BENCH

Fig. 31
Home-made tool holder for bench grinder to grind flat chisels, etc.

control the grinding of a chisel on an emery wheel without the aid of some fixture such as this.

Vise Blocks — In answer to the needs of these in the gun shop, a few are made in the different forms shown in Figure 22. Before a stock or finished barrel is clamped in the vise they should be used. The wooden ones shown with felt glued to the face of the blocks are the ones mostly used by a gunmaker. They can be made from any hardwood measuring $\frac{1}{2}$ to $\frac{7}{8}$ inch thick with a piece of felt glued to the top surface. A notch is cut out on the bottom which straddles the square box of the movable jaw. The felt glued to the face of the blocks protects the surface and finish of all parts clamped between them.

Lead jaws may also be made, as shown in Figure 22, together with the mold to cast them. There are also false brass and copper jaws for holding small metal parts without marring their surface. Heavy brass or copper bent over the vise jaws is satisfactory for metal work in the jaws of the vise where the faces come together. These surfaces are cut like a file, or knurled, and then tempered.

False jaws must be employed, for if the plain knurled surfaces of these jaws are clamped against any work they will necessarily mar and bruise it. Common leather can be glued to these hardened jaws, and even beeswax has been used to retain the leather in place. A satisfactory leather holder is also shown in Figure 22. Two pieces of thin gum wood, the width of the jaws, are used and made much longer than the standard wooden jaws, and two small blocks are used as separators at the bottom. The two outer pieces are nailed or bolted to these, which allows the two ends to spring apart. Thin pieces of leather are glued to the surface, and the spring in the wood keeps them apart. When using these, the spring of the wood follows the vise jaws as they are opened.

Clamps — The gunmaker has so many parts to clamp throughout the various operations he performs that a good supply of clamps is required. Figure 22 illustrates one which is necessary for the restocking of shotguns.

The special home-made tools a student requires are many, but the ingenuity of a mechanical mind

will devise a great number to fit the needs that arise in a small shop. The suggestions made in this chapter are only a means of setting your standard of improvements with what you have at hand.

The student requiring a tool which cannot be procured from the regular source of supply will usually make that particular tool by some method best adapted to his surroundings and by means difficult to suggest in these pages. There are, nevertheless, a number of tools used almost constantly by a gunsmith that a student would never use until he knew the value of such tools and their purposes. I will try to eliminate all unnecessary

tools throughout these chapters and mention only the tools or appliances necessary. They can be used to advantage many times, but their uses are for the student to figure out for himself in the particular trade or profession he may be following.

The financial position of the reader may have the greatest influence upon the situation, but the amateur should discard the idea that he should have all that has been suggested. Build your tools as you need them with the means you have at hand, and you will be surprized to see the tools made by the efforts of your own labor.

CHAPTER III
Materials, Metals,
and Supplies

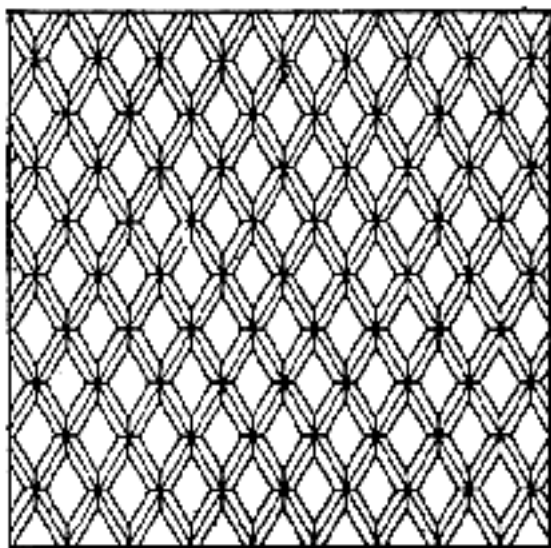

Materials, Metals, and Supplies

IN THIS chapter are set down a list of the supplies which comprise a gunmaker's stock in trade. Some of these things are seldom required, some you perhaps will never use, but this book is written especially for the fellow who wants to complete the array, and perhaps has to do everything in the whole range of gunsmithing by himself, and who, moreover, cannot rush out in the lunch hour and easily buy the things he requires or the services he needs for the next evening's work. Then, again, this book aims to inculcate self-reliance, for the fruit of this is the sweetest satisfaction of all. The product of one's own hand and brain becomes, as it were, a part of one's self.

This extended list runs into a lot of money and becomes quite an investment, but you are not going to buy all these things at once, and you will, after all, use your own judgment as to quantity. As your needs develop, you will therefore turn back to this chapter for the extended information you will require. Nothing is so foolish as to purchase things you will never need; so consider the work you are planning to do, and the scope of it, and let your requirements be your guide. There is one axiom, however, that must never be lost sight of, and that is that one cannot make something out of nothing. An enforced makeshift often displays startling ingenuity and earns great credit, but only because it is a triumph over odds and not because it has real excellence. Now, I am sure you do not want your work to be classed as a makeshift, so do not handicap yourself by inferior materials or the lack of suitable ones.

The materials used by the gunmaker are in general specialties, and most of them are not carried in stock by your local storekeeper. You will have to secure them from a variety of sources, and to serve all occasions, I have given in a Directory, a list of merchants and manufacturers who specialize in these goods. Gather and file the catalogs of these and of our leading tool and accessory makers and dealers. You will find much useful information therein, and will be able to determine just what best suits your requirements and your pocket-book.

In gun work the first essential is precision and then more precision, so start out by arranging your supplies in an orderly and precise manner. Have a place for everything and, as far as possible, keep

everything in its place. You can make simple racks for your steel, and shelves and cupboards for your smaller items. Empty cigar boxes and empty baking-powder cans are ideal containers for your small articles. Be sure to label them so that you will know without fumbling just where to find what you are seeking. Screw-top glass jars are fine for many small parts.

Let us start by enumerating the metals you will need and the forms in which to buy them.

Tool Steel — Tool steel comes in many different grades and is further complicated by many trade names. It is roughly divided into "Standard Carbon Steel" and the so-called "Alloy Steels." The latter are steels alloyed with other metals. These alloys comprise *Nickel*, *Chromium*, *Vanadium*, *Molybdenum*, etc., or combinations of them. All have their specific uses, and in each case nothing else is quite so good. As we advance into actual work, I shall have something to say about these special steels for particular uses, but when we shall hereafter speak of steel in this book, unless otherwise noted, it will be "Standard Carbon Steel." I shall be rather arbitrary in my choice of steels, not because I have an ax to grind, but because my experience has taught me that certain makes and kinds are best, and you will wisely take my word for it. The work we are going to put on this small fragment of metal is so infinitely more costly than the material itself that to economize at the price of quality would be folly.

Steel. Cold Drawn — This comes in an endless variety of sizes and shapes, in rods, bars, and sheets. Your needs, as they arise, will determine what you will want. The following list of sizes will cover some of the things you will certainly want to make.

Size	Use
$\frac{5}{16}$ inch x $\frac{5}{8}$ inch...	Front sight ramp, soldered without ring
$\frac{7}{8}$ inch x $1\frac{1}{4}$ inch...	Front sight ramp, with encircling ring
$\frac{1}{4}$ inch x $\frac{3}{8}$ inch...	Barrel band bases
$\frac{1}{2}$ inch x $\frac{5}{8}$ inch...	Sling-swivel bases
2 inch x 2 inch...	Leaf-sight bases. These are bored barrel diameter and when split make four bases each
$\frac{1}{4}$ inch x $1\frac{1}{4}$ inch (or $1\frac{1}{2}$ inch).....	Quick detachable swivels
22 gauge sheet.....	Barrel bands
18 or 16 gauge sheet..	Butt plates and grip caps

This list could be continued, but it will be better to get the material as needed, for if you should procure sizes on a complete list you would have to open a steel warehouse in connection with your shop.

Steel Drill Rod—Drill rods come in 36 inch lengths, and in sizes from #1 to #80 in drill-gauge dimensions. They are also made in letter and fractional sizes, in squares and in flats. This is very useful material. It makes pins and screws in lock work, firing pins, and cleaning rods, besides endless tools for special purposes. It is invaluable for special reamers, counterbores, checkering tools, matting punches, and screw-drivers.

Spring Steel—The very best spring steels are still made in Great Britain, and for springs of the best shotgun locks it is advisable to obtain this steel. For the ordinary springs you will use in repair work, such as springs for obsolete pistols, muzzle-loading guns, etc., the domestic steel made by Ward or Ryerson will answer the purpose quite well.

Steel Tubing—Shelby steel tubing comes in all required weights and diameters and is particularly useful in many ways. From it you will make barrel bands, foresight protectors, cleaning tubes, bushings, etc. There is also Stainless Steel Tubing, which offers a further advantage for certain purposes we shall mention later.

A special tubing is made by the Ellwood Ivins Tube Works in Philadelphia, Pennsylvania. This company will make any size of tubing from that of a needle up to the largest size, not only in cold-drawn seamless tubing, but tool-steel tubing as well. This tubing is used for the oil tubes of barrel drills, barrel reamers and rifling heads where it is impossible to secure the proper sizes in the standard Shelby tubing. The making of barrels requires more rigid tubing.

A recent use of seamless alloy-steel tubing is for relining rifle barrels. So far these "liners," rifled and ready for insertion, are a means of saving many fine old rifle barrels. As yet these "liners" are exclusively a British product. There are two kinds, those made of ordinary carbon steel and suitable only for lead bullets, and those made of the finest alloy steels and so made suitable for metal-cased bullets. The former, which have the advantage in price, are procurable from A. G. Parker & Company, Birmingham, and the latter from Vickers-Armstrong, Ltd., Grayford, Kent, both in England. They carry a supply of these in various calibers.

Steel Spring Wire—This comes under the name of piano wire and is made in all sizes from #80 to #30. This is the material of which you will make your compression springs. Helical or so-called spiral springs are used in many places in modern firearms, and replacements are often necessary.

Machine Screws—In general use, they are made with two kinds of heads, the flat head and the fillister head. You should have a small stock of both kinds, as these, in addition to their general use, will often replace other special screws which have been lost or broken. The following list covers a multitude of needs. Get them long enough; they can be shortened easily if too long.

Size	Thread	Length
2	64	$\frac{1}{4}$
2	56	$\frac{1}{4}$
3	56	$\frac{3}{8}$
3	48	$\frac{3}{8}$
4	40	$\frac{3}{8}$
4	36	$\frac{3}{8}$
5	40	$\frac{1}{2}$
6	40	$\frac{1}{2}$
6	32	$\frac{1}{2}$
8	32	$\frac{5}{8}$
8	36	$\frac{5}{8}$
10	32	1
12	28	1

Brass—There are a number of uses for this easily worked metal, both in sheet, rod, and bar. A few pieces of rod of different diameters will make drift punches, riveting anvils, special screws, etc., while for small bushings and escutcheons as well as templets, etc., a sheet of 24-gauge brass will be most desirable. Purchase short pieces of $\frac{1}{2}$ -inch, $\frac{3}{4}$ -inch, 1-inch round brass to drive with as well as to hold in the vise to rivet on; also secure the soft sheet brass $\frac{1}{16}$ inch thick for use as vise jaws; and obtain $\frac{1}{4}$ -inch and $\frac{3}{8}$ -inch round brass to drive with and for making special screws, bushings, and escutcheons.

Copper—For drift punches in removing and replacing sights and dovetailed sections, soft copper rod is excellent, and sheet copper $\frac{1}{16}$ inch thick makes the best protecting medium for your vise jaws.

Lead—A small quantity of lead will provide for numerous needs, and you will have no difficulty in getting this in scrap form or at your plumbers. Vise jaws, bench plates, etc., require lead. You will also use it for lapping barrels, ring gauges, chambers, and bullets.

Solder—Solder is an alloy of lead and tin in

various proportions. That used by a tinner is usually 50% lead and 50% tin. A slightly higher proportion of tin—say 60 x 40—is better for gun work.

Silver Solder Spelter is used for brazing operations; *tin* and *bismuth* are employed to harden lead and make the soft solders.

Soldering Salts—Nokorode Soldering Salts are the best on the market for soldering operations. These come in pound tins, and all that is necessary is to add a small amount of water to the salts, put the mixture in a separate jar, and keep it handy on the soldering bench.

Emery—You will need a small quantity of emery powder for your lapping and polishing wheels; #90, #120, and the fine grade called "flour" emery will cover your requirements. The coarse grade is used to true oilstones.

Emery Cake—This is emery combined with grease in a soft cake. It is used to charge the revolving polishing wheel. It is a fast-cutting compound and brings out a good finish on steel parts, such as barrels, etc.

Emery Cloth and Paper—This is your standard abrasive, and you will use it a great deal. The numbers most useful in emery cloth are #1, #0, and #000. It is possible to get even finer cuts than these in emery paper, and so your finest use may require a few sheets of Turkish and French emery paper.

Crocus Cloth—This is the finest abrasive of all. You will need it for your finest polishing.

Sandpaper—This universally used material has been greatly improved of late by making it waterproof. The flexibility of the wet paper makes it more adaptable and prevents scratching. It is also self-cleaning and cuts faster. You will not want anything coarser than #1, and for your finest work 1/0 to 7/0.

Fiber—You will need a small amount of round fiber rod, 1/4 inch to 3/4 inch in diameter, to make into drift punches for use on finished surfaces where even copper would mar and spot. If you do damaskeening this will also be the material you will use as a tool for your abrasive. This material is used by some gunmakers for butt plates and grip caps. It is cheap and easily worked to shape, and for inexpensive work answers quite well. The large round fiber can be turned to various sizes for

removing dents on fine shotguns or rifle barrels where adjustable steel plugs would damage the high polish.

Glue—As all glue is soluble in water, its use is quite limited in gun work. The strongest obtainable is made from hide stock, and the best is imported from France or England. As it must be prepared in a double boiler, a small glue pot is necessary. Remember that glue is strong only when freshly made and quickly applied while piping hot, and that boiling and frequent reheating destroys its strength. For attaching horn and rubber we suggest that you dissolve your glue in linseed oil instead of water, as this renders it more nearly water-proof.

Du Pont Household glue will be found very useful and convenient for repairs, and as it does not require heating, it is always ready for use.

Felt—A small supply in 1/4 and 1/2 inch thicknesses is required with which to line vise-jaw blocks and rub down stocks when ground glass, rottenstone, and pumice are used as polishing mediums.

Horn, Buffalo—This is one of the essential materials of the gunmaker. It is used for butt plates, forearm tips, grip caps, and inlays. Asiatic buffalo horn is the best, and it is wise to buy the entire horn and cut it to shape as you need it. Horn butt plates for the best shotgun work should be imported complete, as these are hydraulically compressed into shape. They may be had in all thicknesses wanted.

Pumice and Rottenstone Powders—These substances are very fine abrasives and are used in obtaining a fine polish on stocks. A small can of each will provide enough for unlimited use.

Wood Screws—These are of so great a variety, and so readily obtainable, that one is hardly justified in carrying a stock. Your work-box will furnish most of your needs.

Steel Wool—This is a necessary article. A pound of #000 will serve all purposes for a long time. Its uses will be made manifest throughout these pages.

The following substances and chemicals are also used in gunsmithing, and are chiefly confined to the surface treatment of materials, either to harden their surfaces, to render them more beautiful, or to add to their preservation. The ones first enumerated and described are those for use in connection with metals.

Acids — Acids, one must always remember, require care both in their use and in their storage. They are often dangerous in combination, destructive to animal and vegetable tissues, and highly poisonous. Some must be kept in special containers and away from direct light. Buy in small quantities, as most of them deteriorate rather quickly.

Sulfuric Acid (commonly called *Oil of Vitriol*)—This is a most powerful acid, and, as its name implies, is derived from sulfur and niter. For the gunsmith it is limited to its use as a cleaning agent, such as removing rust, sand, and other foreign substances from metal.

Nitric Acid (commonly called *Aqua Fortis*)—This acid is derived from niter or saltpeter through decomposition by sulfuric acid. It is a most useful acid, both alone and in combination. It is a constituent of all bluing solutions and is the acid which is used in etching ornaments on steel.

Hydrochloric Acid—In its commercial form this is often called *Muriatic Acid* or *Spirits of Salt*. It is made from common salt by the action thereon of sulfuric acid. It is used by the gunsmith as a flux in the operation of soldering and brazing. Hydrochloric acid combined with nitric acid—one part nitric acid with two parts hydrochloric, by measure—makes *Aqua Regia*. This is used as a component of bluing solutions.

Potassium (Potash)—In its numerous forms this is another chemical of many uses. *Potassium Chlorate*, which is the arch enemy lurking in our fired primers, becomes a useful friend in our bluing formulas. *Potassium Bichromate* and *Potassium Cyanid* are the forms in which it is used as a case-hardening agent. *Potassium Permanganate* is a very useful agent in darkening walnut wood. This will be described in stock finishing. *Potassium Nitrate* is used in coloring steel. Other chemicals besides the Potassiums used in bluing solutions are *Bismuth Chlorid*, *Sulphate of Copper*, *Sulphate of Iron*, or *Copperas*, *Bichlorid of Mercury*, *Ferric Chlorid* and some others of lesser importance.

Ammonia — Commercial ammonia is well known to us all and demands no explanation of its properties or general uses. It is useful to the gunsmith as an agent for the removal of grease preparatory to bluing. *Ammonia Persulphate* mixed with ordinary Ammonia in distilled water makes a valuable cleaning solution, as it will dissolve within the barrel the metal fouling deposited by cupro-nickel-cased bullets. Highly concentrated Ammonia is a most useful agent for darkening walnut and other

hardwoods, as only its fumes are necessary. A finished stock, before oils are applied, can be placed in an air-tight box with open dishes of strong ammonia and the dark color will be attained without moisture. *Ammonia Chlorid* (*Sal Ammoniac*) is used chiefly as a flux in soldering by tinsmiths. For most gun work, *Nokorode Soldering Salts* are preferable. When shotgun ribs are to be soldered, rosin is the safest flux to use, as no injurious residues are deposited.

Alcohol — Two forms are in common use: grain alcohol which, as its name denotes, is distilled from grain, and wood alcohol which is distilled from wood. For all the formulas I shall give, I advise the exclusive use of grain alcohol. As pure alcohol is surrounded by troublesome government restrictions, I advise that in making up my formulas you take the ingredients to your druggist and have him compound them. He will be able to provide the pure, undenatured alcohol which is essential. If this proves inconvenient you can make your own by procuring a small glass laboratory still.

Acetone — This is an alcohol derivative which is a constituent of most cleaning oils and solutions. Remember, always, that acetone is very inflammable.

Mercury (Quicksilver) — This mineral is used by gunsmiths to remove lead from the rifle bore. It has a great affinity for lead, which unites with it, but from which it can subsequently be easily removed.

Sulfur (Brimstone) — This was one of the bases of our good old black gunpowder, but its use in gunsmithing is largely in the making of casts of shell chambers; it is particularly adaptable because of the low temperature in which it melts and the slight shrinking it develops in cooling. It is also used in the tempering bath when making springs.

Camphor — A small supply is all that is necessary to mix with the sulfur in the making of sulfur casts.

The following substances have largely to do with wood work, and while not chemicals in the strict sense, are best classified with them. Let us take the substances used in staining first:

Alkanet Root — A vegetable derivative, which when mixed with your stock oil will impart a reddish tint to wood. *Arnotto*, or *Annato*, an orange red gum, is used to give a similar tint in staining.

This is only soluble in alcohol and therefore cannot be used directly in the polishing oil.

Umber (Raw and Burnt) — A mineral formerly much used as an ingredient in wood stains. It has been superseded by anilins, which are soluble and so penetrate more thoroughly; and they do not obscure the beauty of the grain like insoluble substances.

Dragon's Blood — An old constituent of red wood stains, now superseded by anilins.

Logwood — A very useful dyestuff, but rarely used today in wood stains for the reason above given. It is often used to impart a better black to gun barrels in the bluing process.

We have described the foregoing dyestuffs largely because they are a part of the historic development of staining and will therefore be found in all the old formulas and recipes. My opinion, however, is that the amateur gunsmith will find in the commercial anilin stains, materials more easily obtained, more easily applied, and more easily controlled. The old defect of anilins, their lack of endurance, is now practically overcome. Perhaps of all the old vegetable stains the first one mentioned—Alkanet root—will be the one most generally preferred. Mixed with your stock oil, it will heighten the color of most wood and add to its beauty.

Varnishes and Rubbing Oils — The uses and properties of these substances will be fully described in a later chapter on "Finishing." Here we shall describe them only as substances.

Varnish — All the old varnishes were made of vegetable gums dissolved in linseed oil and turpentine. Only the very toughest and best of these were suitable for gun work. Those known as "Spar Varnishes" are the best, as these resist water most effectually. Valspar is a well-known and worthy representative.

Lacquer — This rather unfortunate word means a number of things, quite different from each other. In the sense in which we employ it here, as a treatment for wood, it is the nitro-cellulose product made by Dupont, called "Duco," and is the best known. Applied with a spray gun it is the modern substitute for varnish in nearly every case. If one has to varnish a gun stock, well—don't; lacquer it instead. It is quicker and in every way better.

Shellac — Shellac is a varnish made from a gum secreted by an insect and dissolved in alcohol.

Some gunmakers use it in connection with linseed oil and then it is known as "French Polish." Its use in gun work is passing, the lacquer above mentioned is taking its place.

Linseed Oil — This, the only oil adapted to the preservation and finishing of wood, is derived from flaxseed. It is at its very best when it has been extracted from the seed by pressure only, and without heat. This grade, however, is not generally procurable in America. Linseed oil comes either "raw," as it is called, or "boiled." One must here be reminded that there is "boiled oil," which is oil actually boiled in a vacuum, and the commercial "boiled oil," which is merely raw linseed oil combined with certain "dryers." For the gunsmith the latter is worthless—he must have the really boiled article. As there is a use in gunsmithing for both the raw and the boiled, your supply should include a small bottle of each.

Oils (Lubricating and Preservative) — This is a subject that is provocative of much argument and difference of opinion. There are uncompromising opinions regarding all these classes of oil: animal, mineral, and vegetable, and all their combinations. Perhaps the best line of argument I can take is to give you my preference, and then if you disagree with me, it will be like a conversation on the radio—one-sided. Far be it from me to disparage any of the well-known, highly advertised lubricating oils, as they are excellent for most purposes. It just happens that I "sat in" on long courses of experimentation conducted by the U. S. Government chemists to determine the best oils and greases for use in the Springfield and other United States arsenals. It was found that for the lubrication of guns, an oil consisting of 10 parts pure sperm and 1 part paraffin specially refined, boiled together, was the best obtainable; and that a heavy grease, made under a proprietary formula by E. H. Houghton of Philadelphia and having the trade name of No. 82 and 84 "Cosmic," to 8 parts of which was added 2 of pure sperm, was the very best preservative. Sperm oil is obtained from the head of the sperm whale. Both are entirely free from acid; both are non-drying. This means that they not only do the work required of them, but that they keep on doing it, and your gun, in use or in storage, is safe and sure. This information solved all my oil problems for the moment and, I believe, forever.

Among the other oils needed is *lard oil*, for use in cutting screw threads, and for cutting, reaming, and lapping operations generally. *Kerosene* is used for loosening up corroded joints, and *Sperm Oil* has a number of uses, especially in connection with

rifles—uses which will appear as the workman goes further into actual gunsmithing.

Varnish Remover — Have a small can of this in stock, for it is a great time saver in removing the old varnish from a stock, preparatory to re-finishing it.

Beeswax — Beeswax is sometimes used as a polishing agent, but as it is affected by moisture, it is not well adapted for wood work on guns. It is no substitute for the combination of one part linseed oil and ten parts elbow grease. A little, perhaps, added to the oil, accelerates results. It finds a use in the gunmaker's supplies for coating surfaces in the etching process.

Ivory — Since ivory is becoming very rare, it is more expensive than formerly. It is used for pistol-grip caps, forearm tips, inlays and grips for revolvers and pistols, and for special sights on shot-guns and rifles. Old billiard balls of ivory may be picked up at times and will supply your needs.

Charcoal — Charcoal, you will need in your furnace as fuel, and also in a powdered form for bluing small parts. That made from willow wood is esteemed the best, but you will be satisfied with that commercially obtained. Charcoal is also used to cover lead in hardening operations.

Lacquers for Metal — These lacquers have no relationship with the automobile lacquers formerly described. Their composition is of no interest to the gunsmith. They may be obtained from dealers in metallic finishes and are applied to metal previously made warm. Their uses will be described in the chapter on metal finishing.

Rouge or Ferric Oxid — This is the finest of all abrasives and is used to give the highest possible polish to steel and other metals.

Prussian Blue — A tube of Prussian blue, procured from your paint dealer, will provide the best material in your trial and error operation in all your close-fitting metal-to-metal work. In fitting steel to wood, lampblack made into a paste with oil is rather more satisfactory.

Bone-black — A pound of this will also be necessary to have at hand. This is used to coat exposed and delicate points when mixed with sperm oil into a paste in the heating and hardening process.

Water — Distilled water should be invariably used in every chemical formula. A *saturated solution* means all, and no more, of any soluble substance that can be held in suspension in the liquid.

Woods — The woods for stocks are best secured from Mitchell Bosley of Birmingham and J. R. Owen of Liverpool, England. They carry the finest of the Circassian, French, and Italian walnuts. For the supply of American walnuts, Harner of Springfield, Ohio, has a very fine selection. It is best to have these cut to standard size for the particular firearms you wish to restock. You will need a supply for odds and ends in order to do considerable patching, and the local supply of American walnut answers that purpose. You will also need pieces of ebony, rosewood, mahogany, cherry, and maple woods. These are very attractive, especially the rare varieties. A separate chapter will be devoted to this subject. See "Selection of Woods" before any steps are taken to secure the supply required.

CHAPTER IV
The Use of Tools

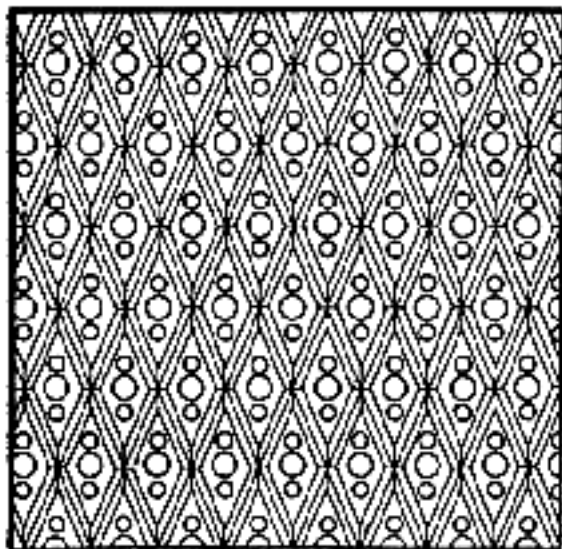

The Use of Tools

CERTAIN individuals seem naturally adept in the use of tools, while others must receive definite instruction before they can make progress. It is for the latter class that this chapter is written. Everyone attempting a task wishes to do it correctly, and the student, having located his shop and purchased or made some of the tools, often finds himself in a quandary, not knowing how to perform the simplest operations, such as sharpening a wood chisel, driving a nail, or using a file in the right manner.

Throughout this chapter I have endeavored to treat each subject so that the novice will clearly understand most of the tools used by a gunsmith. Naturally, a number of topics are not touched upon, but enough is included to give adequate working knowledge. What follows may be of little use to the finished craftsman, but the beginner should read it carefully in the hope of acquiring an understanding that could otherwise be had only by apprenticeship.

Wood-working tools will be considered first because of their interest to the beginner. Edge tools of all kinds come ground, but not stoned, therefore it is necessary to understand first how to sharpen and keep them in condition to do the best work.

WOOD-WORKING TOOLS

Chisels — The wood chisel, carving chisel, gouge, and bottoming tool are the most important in stock inletting. You can buy chisels such as the short butt chisels which save time, and you can also fashion them from old files. Grind off the file cuts, being careful not to draw the temper while doing so, and sharpen the end by holding it flat against the emery wheel as it revolves to secure the proper angle. On all gunmakers' chisels the angle is twice as great as on carpenter chisels. With a long sharp angle, the cutting edge performs better on hard woods. The grinding of a radius on the cutting edge of a chisel reduces to a minimum the necessity for stoning. It is advisable to grind a 1 or 2 degree angle on the flat side so that it will not bite in that direction, but take out a straight clean cut. It is impossible to do this with gouges, since they are made with a diversity of radii and a very steep

angle to the cutting edge, with only a very slight angle on the flat side.

Carving chisels come under the same heading as gouges and are made in many different forms. The reversed radius gouges are seldom used on stock work and may be added to one's kit when occasion for their use arises.

The chisels you buy usually come rough-ground and with a short angle. Re grind this angle as described, near to the cutting edge; then reverse the same on the emery wheel so that a short radius will be ground about one sixty-fourth to the cutting edge. While grinding, always be careful to grind straight across so that the cutting edge will not be canted to one side. Like instructions should be followed for chisels made from old worn files. As machine shops are always accumulating old files, a good supply can usually be obtained without much effort. Your choice should be: flat mill, half round, three square, and pillar files. Those of the narrow pillar variety can be made into small narrow chisels, and the different-shaped needle files can be ground for small inletting work such as shields, etc. Your needs will be confined mostly to 6 and 8 inch lengths, the 10 and 12 inch being rather cumbersome for general use. The 10 inch mill file may be broken in half and ground for wide butt chisels.

Another type of thin chisel is made from power hack-saw blades, broken to the proper length, the teeth ground off, and a tang ground on the end to fit a file handle. A full set of these tools is inexpensive, not difficult in construction, and the work will be most interesting to the beginner.

In stoning, first use a coarse carborundum stone to hasten the work on the cutting edge, and a Washita or any fine-grained stone to obtain the desired keenness. Get a piece of 3 inch belt leather, 12 inches in length, and glue the smooth side to a convenient place on the bench; use it to rub the working chisel on now and then as needed. Charge the leather with 320-M optical emery by mixing it into a paste with olive oil, and rub well into the leather. By drawing your chisels toward you, as tho you were stropping a razor, you reestablish and maintain the sharp cutting edge. This device is used for flat chisels and gouges on the straight side. Most carving chisels have odd shapes and radii but

you will observe that the gouges have, in most instances, a true radius. To stop these, the best results are obtained with a buffing wheel mounted either on a buffing-wheel stand or emery-wheel spindle. Charge the wheel with rouge or chrome-plating polish as a light abrasive. When the tool is stoned and you wish to complete the stropping operation, all that is necessary is to hold gouge or carving chisel against the fast-revolving wheel at an angle of 80 to 85 degrees from the horizontal; or hold the tool near the bottom of the wheel to secure the proper edge. Only one thickness of a $\frac{1}{4}$ inch sewn muslin wheel is required to bring the edge to a fine cutting design.

When using the buffing wheel, hold the tool close to a vertical position, bringing it against the wheel gently. This method will give it a razor edge, the condition in which it should be kept. It is wise, at the first sign of dulness, to touch it up on the wheel, thus returning to the razor edge the possibility of making a smooth polished cut against the grain of the wood.

When making chisels from old files and after grinding, draw to a blue just verging on purple. Procure suitable handles with heavy steel ferrules for protection in the use of a mallet. Generally speaking, chisels used in conjunction with a mallet are of the ordinary carpenter kind, reground, while home-made thin chisels are for hand use only.

Only rudimentary instruction can be imparted to the beginner in the use of the different chisels, since proficiency will depend largely on practise and experience. In the use of the many forms of hand chisels, the hold varies slightly, but speaking generally, the right hand is the pushing force and the left acts as the guide. If you are the least bit artistic you will find it gratifying to watch your ability grow, particularly in the application of the small carving chisels. In fitting actions into stocks, the wide short-butt chisels will be found the best, for with these you can take off the thinnest shaving cleanly.

Draw-Knife — Most of us are familiar with this tool, but very few understand its proper use in shaping a stock. Strange but true, the American stock maker uses it far less frequently than the spoke-shave; a matter of fashion and teaching, I suppose. When it is razor keen, it is a reliable and thoroughly efficient tool. Instead of taking the long strokes you see a carpenter use, hold the knife at an angle or let the left hand extend further than the right and only take off small chips with a kind of motion as tho you would gouge out the wood with each stroke, cutting across and at times against the grain without splitting the wood. Of

course, on straight-grained blanks you can take longer strokes, thereby reducing the surplus wood more rapidly. Do not go too far in your cuts, and bear in mind that the spoke-shave is used to continue where the draw-knife leaves off.

One of the best instruments of this kind is the wheelwright draw-knife with round handles close to the blade. With such a knife the cuts are controlled better, whether from or toward you.

Planes — When the student begins to use a plane he holds it at an angle instead of pushing it in a straight line, and you will find that a great many carpenters do the same thing. Turning the tool sidewise permits it to follow an uneven surface and your work becomes more or less out of square. Holding the plane straight is highly important in laying out the top lines of a stock correctly; and for this it is advisable to use a jack-plane.

When starting to plane, use the lightest cuts possible, the blade scarcely scraping the wood. Then set the cutter just a little deeper, until thin transparent shavings are produced the full width of the blade. When you find that you are cutting against the grain, reverse the piece of work and plane from the opposite end. Should the grain run in different directions, take only the finest cuts possible to avoid fraying and tearing the fibers.

In the use of the smooth plane to clean up a rough piece of wood, it is permissible to turn the plane at any angle to cut the high points off the work; follow, however, by straight cuts to attain the desired level surface from which the remaining sides are trued.

When first examining a new plane you will find that the blade is rough-ground only; it is therefore necessary to stone it to secure the proper results. Have a combination coarse and fine oilstone located at one end of the work-bench recessed in a wooden block, so that it is stationary and can be reversed from fine to coarse. To stone the blade, turn the smooth side up. Apply a few drops of sperm oil on the center of the stone. Hold the plane blade with both hands with top of angle resting on the stone. Slowly bring the cutting edge to the stone, and move the blade in a circular motion without too much pressure. Examine often to see that you have a straight line along the cutting edge of the blade. This will be indicated by a bright edge. Now reverse the blade, lay the flat side down, and draw it back and forth until the bright stoned edge also shows in a straight line as on the opposite side. Now start stoning lengthwise on the angle to remove the wire edge, reverse and do likewise until all of it has disappeared. Use the lily-white Washita oilstone; stone the blade in the

same manner as last described, and when you run it across the top of your finger-nail you will note the sign of a saw edge. If you examine this rough edge under a magnifying glass it will look like a number of fine saw teeth which are easily detected with the top of the finger-nail. After these are removed by the white Washita or Arkansas stone, strop the edge on the belt leather as described for wood chisels until you are able to cut a hair with it quite as readily as with a razor after being stropped. This procedure applies to all plane blades, but, of course, the angles differ in certain types, necessitating slight changes in position when stoning.

When assembling the plane, note the amount of projection of the blade through the slot. If too high on one side and low on the opposite, it can be adjusted by means of a lever under the blade on top side which shifts the position until it becomes perfectly even. The adjusting screw regulates the thickness of the cut, which can be adjusted to produce the thinnest of shavings.

Rasps — These are manipulated in the same manner as files, are extremely useful, have a broad field, are quite simple to work with, and are the beginner's most important tools. Even tho you are able to remove wood easily with such a tool, you must bear in mind that it is possible, at least for some workmen, to do much better work with other tools when a more advanced stage of adeptness is arrived at.

Rasps come in different sizes and cuts and are known as rasp, cabinet, and vixen. The two mostly used in stock work are the rasp and the cabinet. The cabinet rasps are thinner with very little radius on the curved side. The rasp is used only on wood where it is impossible to use any other tool to cut down to shape, such as in a butt stock that has been cut from the stump and where the knots and burls stand out prominently. It is surprizing how rapidly the beginner becomes proficient with these implements; and he will accomplish better results, by far, when he uses them on such wood as curly maple, stump walnut, etc. When you get down to the outlines of the stock, finish with a bastard and a mill-cut file before sanding. Good rasps are rather expensive and it doesn't take long to wear one out on hard wood. When the teeth become dull it is better to discard it altogether, for you will require fifty strokes with a worn rasp to one stroke with a new one. When you want exercise to develop muscle in your shoulders and arms, a worn file or rasp will accomplish the desired effect. A vixen file is used on aluminum and for barrel striking.

Saws — The saws which gunsmiths use are a good crosscut, rip, hack, coping, jeweler's hack, and small cabinet. The first two are used for all the rough sawing required, and when used with care will last a long time without any sharpening. Of course if you allow it to hit your vise, or saw into nails, it doesn't take long to dull the teeth. If this happens often, it is best to learn how to file a saw, for which a special vise is convenient. To do this, clamp the saw in the vise, and with a triangular saw-file start to file the first tooth at the same angle as the original cut. Hold the angle, and file every other tooth until they come up to very sharp points. Reverse the saw in the vise and file the opposite tooth from the other side. Before starting to file, take a straight edge and lay over the teeth. If they do not come up even, take a 12-inch mill file and just touch the tops of the teeth until all are even.

It is difficult to give instructions for the use of a wood saw, for the control of a saw is only developed by practise, and it is well for the beginner to use test pieces to see how straight he can keep to a line with both saws, one for cross-cutting the grain of the wood and the rip-saw to cut with the grain.

You will find that the hack-saw is the most useful of all, since it is adapted to both metal and wood. The Atkins silver-steel blades, I believe, are best. The length of blade should be 12 inches with 24 or 32 teeth to the inch. The coarse teeth are used when cutting steel and wood of large size, and the fine teeth for light work, small stock, and sheet metal. When a blade wears down you can grind off the sides of the teeth and use it to slot screw-heads, etc.

The jeweler's hack-saw is used extensively by the gunsmith, and as the blades cost only ten cents per dozen it is a good investment to buy five or six dozen in different widths and numbers of teeth. This saw is used for cutting off small parts, cutting screw-driver slots in small screws, etc.; it is impossible to list here the multiplicity of its uses. In practise many blades are unavoidably broken; however, knowledge of the use of the tool is so desirable that this should not lend discouragement.

The coping saw is used for cutting out odd forms in wood and templet work when it is necessary to follow lines. This is more readily possible because the blade can be turned to any position in the frame. For cutting out pistol-grip caps from buffalo horn and ivory, it is indispensable.

Spoke-shave — This is one of the wood-working tools the amateur should by all means become accustomed to, especially in shaping the outlines of

a stock. It is one of the easiest devices to understand when you once see the advantage gained in its use. Without a doubt, its employment is becoming more or less obsolete among American workmen; but European gunmakers usually have a complete collection in perfect order in their tool chests, and prize them highly. You will be startled to see how rapidly you can remove wood with one of these little tools, working the shave both from and toward you, the same as with a draw-knife.

When grinding the blade it is necessary to have a convex form up to the cutting edge on the part which projects from the wooden handle. On the under side of the knife, it needs a long angle to free the chips. After stoning the cutter to a keen edge, place it against the muslin wheel charged with rouge as explained in finishing gouges or chisels with odd forms. It should be set, usually, for the shallowest of cuts.

I use various spoke-shaves on stock work, from the very smallest for odd forms on shotgun stocks to the regular size which is used for roughing down wherever possible. With one of these little tools you can see what you are doing when shaping a stock blank, but with a cabinet rasp, an uneven surface results which makes it difficult to keep in mind the outline of your work. On difficult wood it is advisable to resort to one of the rasps, for here it is next to impossible to use a shave because of knots and diversity of grain.

Wood Bits — These are essentially for boring into wood, but other forms are also employed. The wood bit is frequently used in gun work, and it is advisable to buy the very best, for the hard wood of gun stocks dulls its quickly. Look over an assortment of needle files and select a suitable one to keep your bit sharp. File from the inside; sharpening the side lip from the outside will cause it to bind in the hole and pull the spur free from the wood.

Center bits are used to start the Forstner bits when shallow holes are required, the Forstner bits being used in producing a flat-bottom hole. As these are only used on shotgun stocks you will find that they do not require sharpening as often as the auger bits. However, identical methods are employed when it is needed.

In selecting a brace, choose the best with a large strong chuck that runs true, and has a sweep of between 10 and 12 inches. When a bit is centered there should be no running out. Occasionally it is the bit itself which is being sprung, and it is impossible to bore a straight hole with one so modified, especially when recessing in the butt for accessories, as these holes are bored the full length

of the bit. You must have the combination of bit and brace running in absolute alinement. To have a bit come through the side of a finished stock is a calamity and humiliation great enough to make one realize that it is advisable to have everything running true from the very first. Before starting operations which require the use of either auger, center or Forstner bit, lay out your work by marking the centers plainly with a center punch. There is no excuse for holes being out of center. When this happens it is due to guess-work or haste.

In the instance of twist drills used in a brace, grind the drills back longer than in the case of steel. Drills any smaller than $\frac{1}{4}$ inch should be used in a hand drill.

METAL-WORKING TOOLS

Drills and Drilling — In the armamentarium of the metal worker's tools, none has a more definite or important place than the twist drill. One-half the metal is cut away in the flutes, but notwithstanding this, the cutting surface, in proportion to its cross-sectional area, is large. This is made possible by the fact that the walls through which it passes act as a support, and the feed pressure forces the point into a cone-shaped hole which centers it. Drills should be ground so as to cut to actual diameter and be capable of operation with as little power or pressure as possible. To have one cut to correct size, both lips should be of the same angle. A great convenience is to buy a standard drill gauge (shown in Figure 32). These are

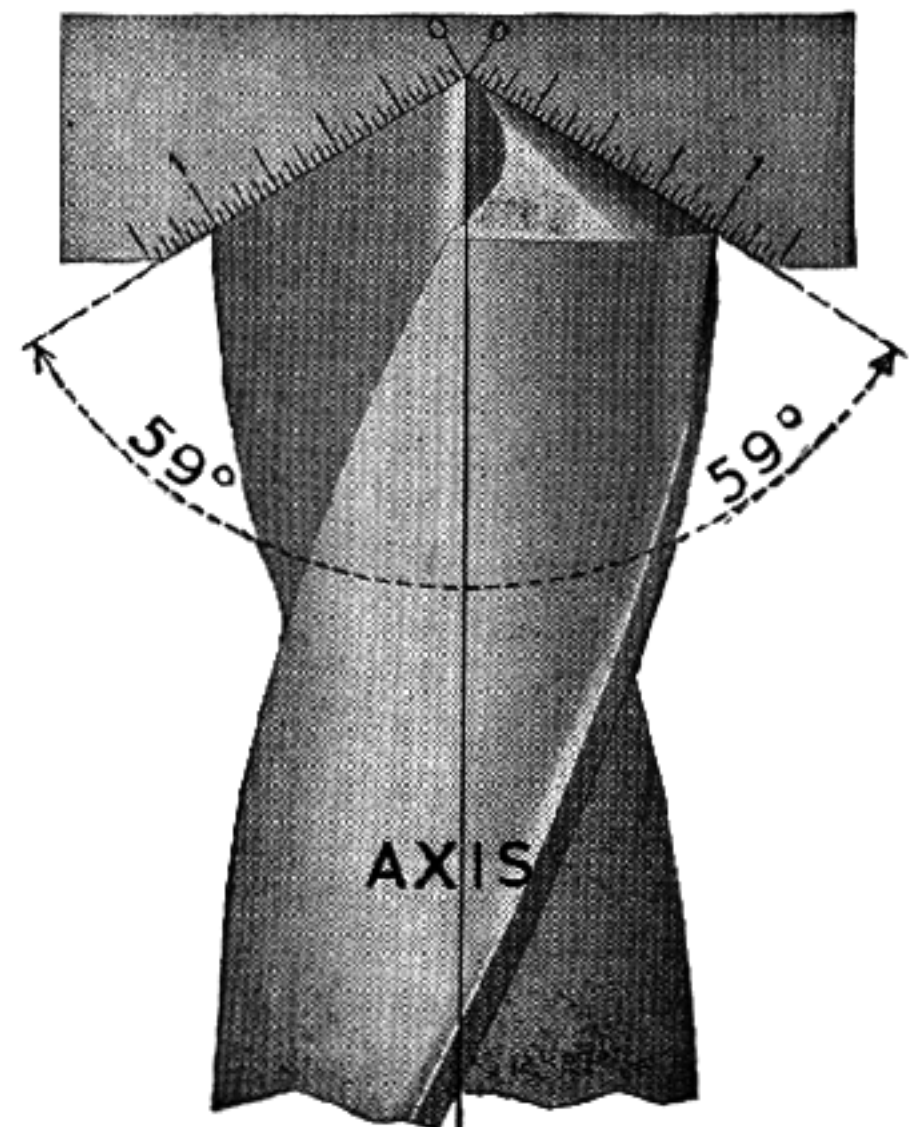

Fig. 32
Correctly ground lips. The two lips are of the same length and the same angle to the axis

made from sheet steel with an angle of 59 degrees and graduated on the angle portion, so that when the drill is reversed, both sides check to the center. After acquiring the knack of grinding them it is no more difficult to grind a Number 52 than a 2-inch, and the same holds true for giving correct relief. Start from the cutting edge and roll it back; then reverse the drill to opposite side and repeat the operation. This does not assure microscopically perfect size, but the accuracy of the eyes is sufficient for all practical purposes here to determine if both angles are correct, and sides are of equal length. Should one side be longer than the other, the drill will cut oversize, and in the case of a large drill the aperture would be enlarged considerably. Small-number drills are stoned; they are too small to be ground. By stoning a small radius on the edge or lip of any size drill, it may be used as a reamer by drilling first with a smaller drill, and then using the one so treated until the desired smooth opening is acquired.

For drilling brass or any thin stock where the drill goes clear through, it is best to grind or stone a narrow bevel on the cutting edge. Figure 33 il-



Fig. 33
Special grinding for
hard metal or brass

lustrates the edge to stone. This goes away with the tendency to draw into the work, which means removing more than it should, especially at the bottom of the opening where it breaks through. To avoid this, grind as heretofore explained—from the cutting edge.

Drilling Holes in Glass—A number of methods are offered for choice. For holes of medium and large sizes, use either brass or Shelby tubing having a diameter equal to that of the opening required, as illustrated in Figure 34, or make up special drills from cold-drawn steel. The cutting face in each instance should have a smooth, flat, circular surface. The speed should be about 100 feet per minute, or just fast enough to have the

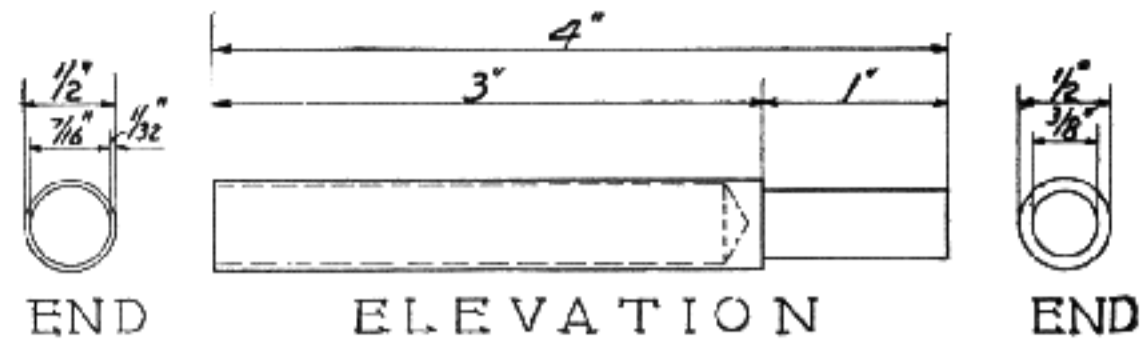

Fig. 34
Glass drill

emery cut well. Use either 90 or 100 emery or carborundum and water between the end of the drill, tubing, and glass. Place the abrasive under the drill with a thin piece of soft wood to avoid scratching the surrounding glass. Construct a wooden box so that the grit-impregnated water will not run over the drill-press table or floor. Cushion the glass with a piece of rubber with an opening in the center not larger than the one to be drilled. When drilling, it is best to penetrate approximately half-way and then turn the glass and drill from the opposite direction. Any fin left in the hole can be easily removed with a round file dipped in turpentine. It is possible to drill small holes by grinding the triangular end of a three-cornered file to a taper, and using it as a drill tool. For a lubricant, use a mixture of turpentine and camphor. Holes up to $\frac{1}{2}$ inch in diameter can be drilled in glass with a flat drill by hardening it in sulfurous acid, and using a mixture of turpentine and camphor as a lubricant. The most successful glass drilling is accomplished with such implements as are shown in Figure 34.

Drill Troubles—Twist drills will stand more in proportion to their size and weight than almost any other tools, and when a good one does give trouble it is due to neglect. When drills chip on the edge, the lip clearance is too great and fails to support the cutting edge. If the outer corner wears, it shows that the speed is too great. Figure 35

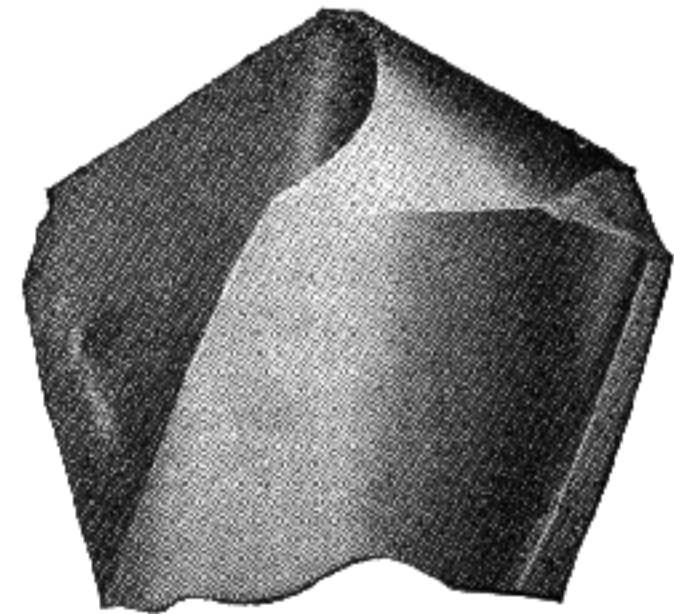
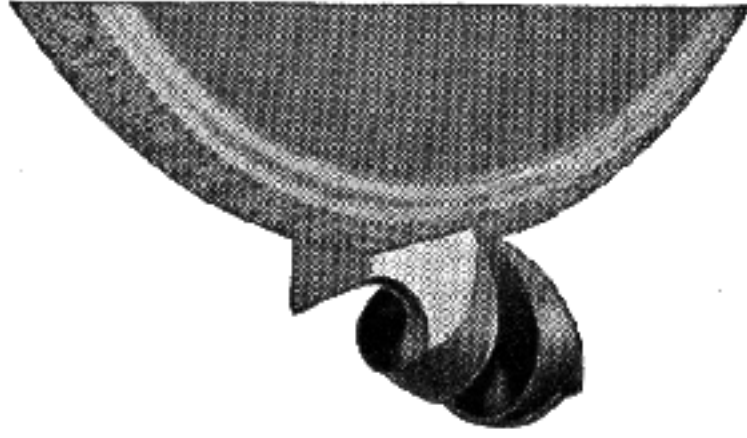
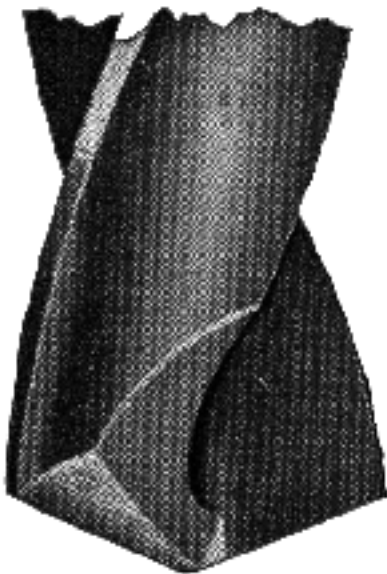

Fig. 35
An indication of too great speed:
The outer corners of the drill
have been worn away because
excessive speed has drawn the
temper

shows this defect. This is particularly noticeable on cast iron. Always keep drills sharp and watch the speeds and feeds, and above all keep them well lubricated with a free cutting oil, such as lard



A



B

Fig. 36

(A) Thinning the web of a drill on an emery wheel. (B) Showing where the wheel has removed the metal

oil. When using small drills at high speed, a wonderful help is to moisten them with the index finger dipped in oil. In drilling hard material use turpentine as a lubricant. Drills feed more easily by carefully thinning the extreme point. Figure 36 illustrates this. This is important in hand feeding with drills at or over $\frac{5}{16}$ in diameter.

When metal has been case-hardened or tempered,

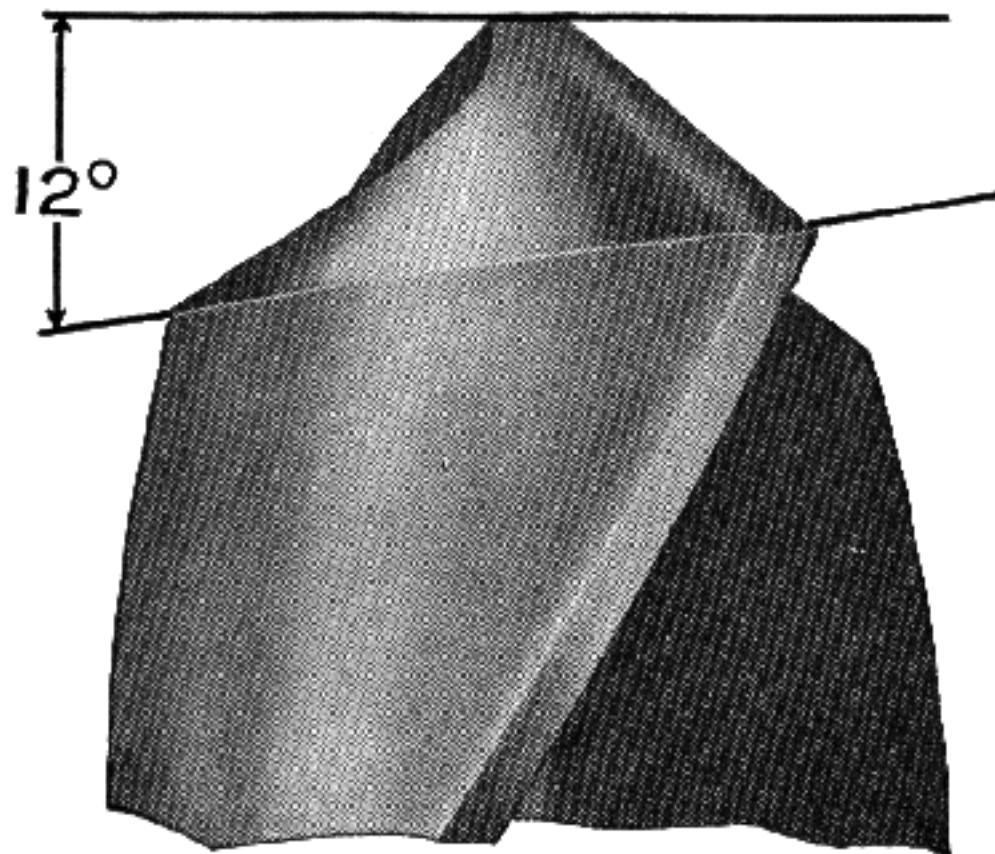

Fig. 37

Correct lip clearance, showing proper way to grind the surface back of the cutting lip

it is best to spot-anneal by building wet clay around the spot that is to be drilled, and heating over the Bunsen burner. Or spot-anneal with an acetylene torch; or a spot can be ground off so that the drill will start. In drilling material of this texture, grind the tool as flat as possible; it will cut much better on all hardened parts, using a low speed and turpentine as the lubricant.

Often a drill can be used in place of the regular tool for counterbores. Start the opening with a regulation-ground drill and then replace with one of the same size, but ground flat and with just

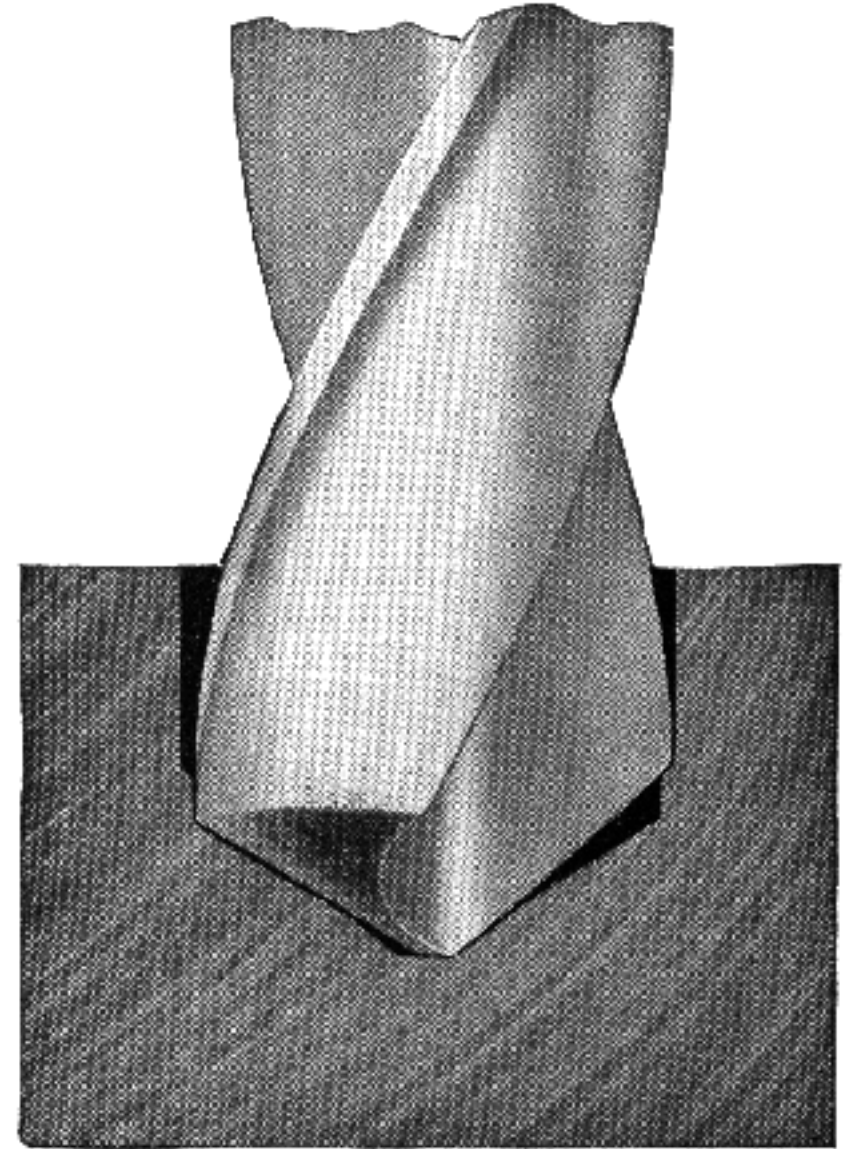

Fig. 38

Incorrectly ground lips. Here we see the angles of lips to be equal, but their lengths are different

enough clearance to insure its cutting. These we call "bottoming drills"; they will do for holes where special care is necessary.

When using metal-cutting drills for wood, increase the angle to 30 degrees on a side and give the drill a considerable amount of clearance so the chips will come out freely and not act as a brake. High-speed drills cost a little more than carbon drills and are the ones used mostly in gun work. For wood, the common carbon drills do very nicely, but for steel the former will outlast a carbon drill two to one.

The Drill Press and Its Use—Many operations can be performed on this machine, such as using it for inlay work on wood, as a milling machine to cut out grooves in shotgun hammers, to set sights in revolvers, grooves in sight bases for covers, to mor-

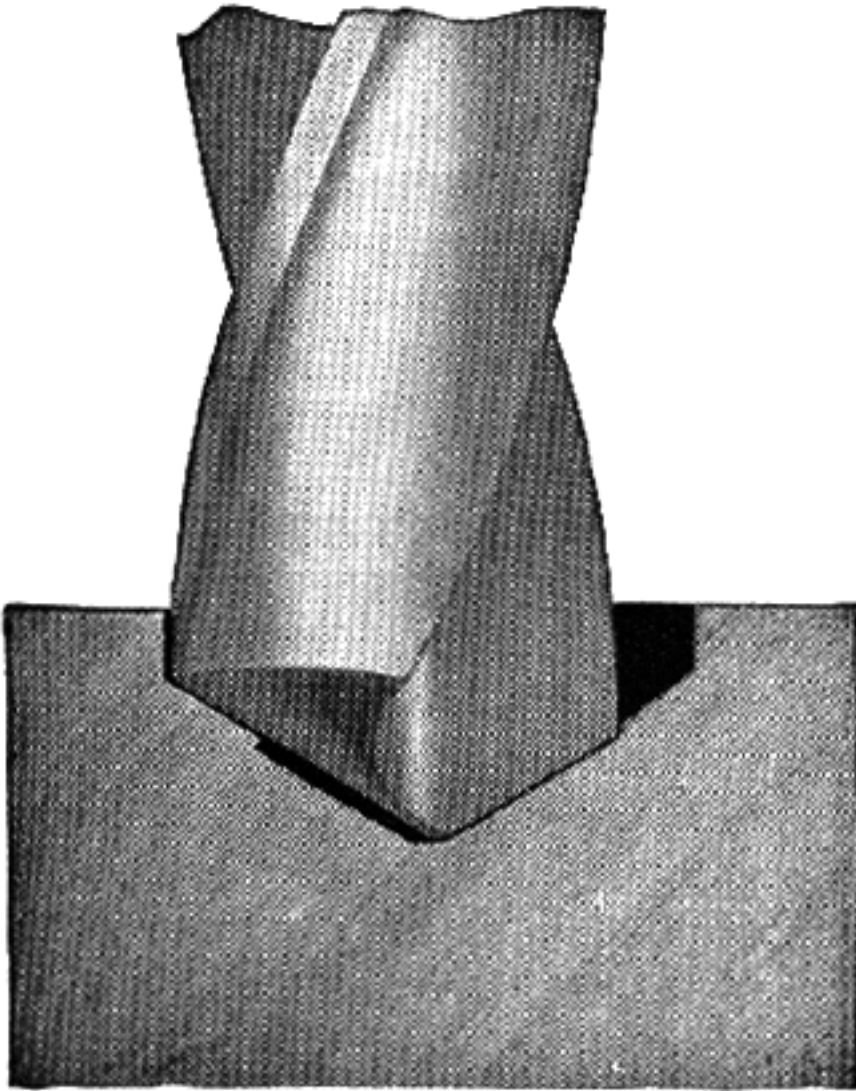

Fig. 39
Incorrectly ground lips. When this drill was ground the two lips were different. Note that the hole is larger than the drill

tise long grooves, as in checkering frames, square wooden sections, etc.

A surprising number of different set-ups can be arranged on one of these machines, from the drilling of holes in steel or wood to using it for special cut-outs. As an instance, suppose you wish to set in a piece of ebony or ivory. It is difficult to ex-

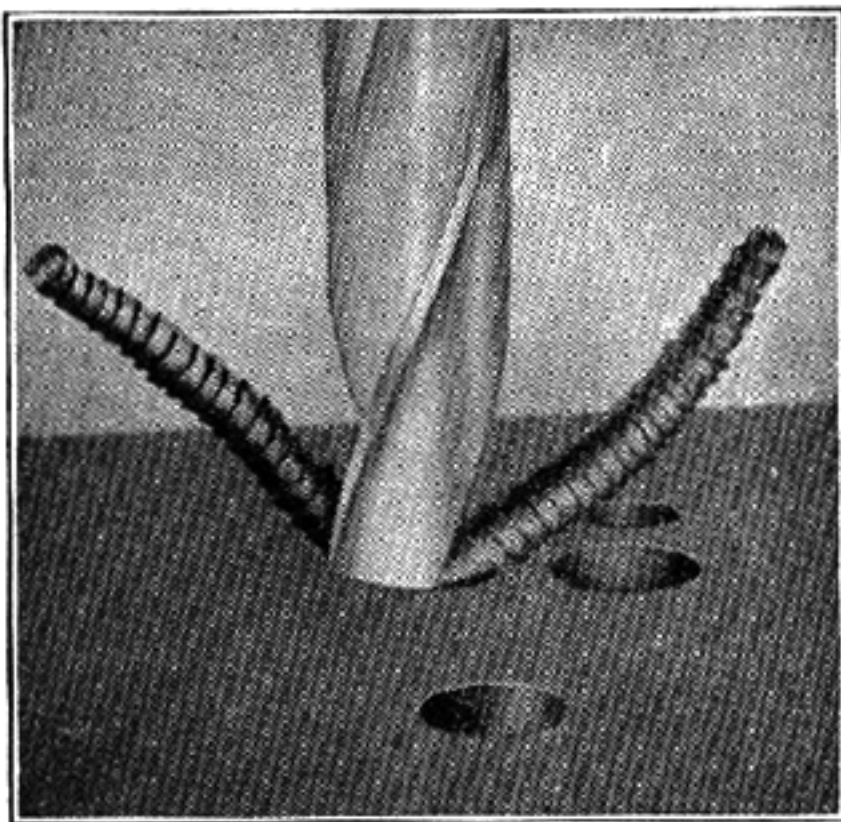

Fig. 40
The correctly ground drill. Note how compactly these chips fit into each other

cavate for this by hand. When it is possible to do this with the aid of the drill press, a small fishtail cutter can be formed out of a piece of drill rod. File it to the required size, and harden and temper. This cutter should be small and driven at high

speed. Set the piece in the drill-press vise and place a block of wood so the back of the vise will ride squarely against it. Place stops for the required lengths, setting them on the feed handle so as to require only slight pressure to bring the cutter a mite deeper. A light outlining cut results in a milled-out recess for the inlay. For mortising, buy

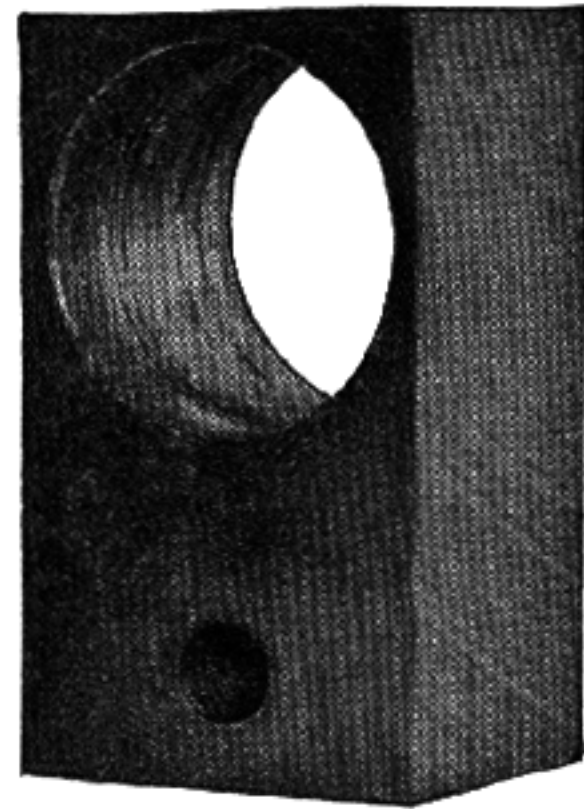

Fig. 41
A rough, inaccurate hole—the result of a dull drill or worn outer edges

spiral end mills up to $\frac{1}{2}$ inch; these can also be used for surfacing wood work. They produce a well-finished surface and all that is afterwards necessary is to sand and polish. A drill press can also be used for lapping, filing, and polishing screws. For reason of its innumerable uses it pays to add such a machine to your shop equipment. If it is not practical to buy a regularly made drill press, secure a smaller one which with motor attachment may be made to answer the purpose satisfactorily.

Files and Filing—The file plays a most important part in the gunsmith's trade as well as that of die makers, and it would be difficult to conceive of a piece of work in the construction of which it does not find its use. Proficiency in the file's use demands practise, accuracy, and patience. While employed as a die maker, it took me two weeks to file out one die block which made two tumblers. In the hands of the craftsman it marks a degree of skill that never fails to impress. In general practise files are designed both by the spacing of their teeth and the shape and cross-section of steel on which they are cut. The size always refers to their length, which is measured from the point or end of the file proper and never includes the tang that fits into the handle.

Terms Used for Files—The back of the file is

the convex or rounded or half-round side. Cabinet and other files have similar sides. The second cut is finer than the first. Some prefer the single-cut for filing in lathes, and I am of the opinion that the best results are secured with this style when draw-filing a barrel or similar work.

Careful observers will notice that a file does not cut well when new, but rather that it is at its best after it has been used for a while, and that its proficiency terminates suddenly, not gradually. Gunmakers of past generations accomplished marvelous results with the aid of little more than this simple implement. I have studied the locks and actions of many an old weapon and unhesitatingly concede that their makers were real craftsmen, highly trained and possessed of wonderful artistic ability. Examples of their efforts are destined to live through the ages in the different museums of the world. True, very fine work is turned out by men with a file today, but we are living in a machine age when it is possible to eliminate much of the time-consuming toil, leaving only the finishing process to be done by hand.

The best advice for the beginner is that he should first of all learn how to use a file, good practise being to reshape into correct alinement test-pieces of steel that are out of square. Let him consider also the proper manipulation of flat files and acquire the habit of making strokes in a straight line without rocking, so that a perfectly flat surface follows instead of a rounded one. Convexity of surface may be detected by placing a small amount of Prussian blue or lampblack on a face plate or any other which is perfectly flat and sliding it over the part being filed, the high points being thereby revealed. Apply the file in a manner that brings it into contact only with these elevations, testing meanwhile for square and level qualities. It is necessary to hold any and all work firmly in a vise. Holding a file without rocking it, so that the stroke is taken on an even plane, is a matter governed entirely by painstaking practise.

Manufacturers furnish the trade with many kinds, shapes, and sizes of files, yet no one works for long before he feels the want of a design for a particular angle or bit of work that has never appeared in a catalog. For this, do not hesitate to grind one that comes nearest your requirements into the pattern you desire, for files are cheap considering the work they perform, and a special file ground today will always come in handy in the future.

This reminds me of an incident that strongly impressed on my mind the importance of such a tool.

During my early days in the Northwest, I

stopped one night with a Swedish sheepherder. As I drove up to his camp I was greeted with the irresistible odor of mutton stew and coffee, and the unforgettable sight of a steaming pan of biscuits. The ill-disguised rapture on my face no doubt moved this herder to generosity and he insisted that I help in the consumption of these delicacies. I accepted with a celerity that gave my host no opportunity to change his mind. After putting away as much stew, coffee, and biscuits as possible for one of my proportions, I sat back contented and listened to his conversation. He was most anxious to recount to me the story of one of his recent accomplishments.

It seems that only a few days before our meeting he had accidentally filled the muzzle of his rifle with gumbo and then shot at a coyote. The result was naturally disastrous—the muzzle was blown off up to the front-sight slot. In a vicinity where coyotes are thick, a herder without a gun is about as useful as a cowpuncher without a horse. Undaunted by so small an incident as having a portion of his rifle muzzle destroyed, he immediately set about to remedy this situation. Rummaging about, he unearthed a file, or rather the remains of what had once been that useful article. After roping the gun to the bottom of the wagon the barrel was filed off square, or nearly so, until no vestige of the recent disaster could be detected. Slots were filed in the hexagon barrel and in lieu of a front sight a piece of baling wire was wound in place. The important thing, tho, was that it was serviceable and shot satisfactorily. Not a bad job for a sheepherder.

Grinding — A most valuable addition to a well-equipped shop is a small grinder. Throughout the book I have mentioned grinding often, and the use of the grinder for polishing operations. There are a number of good, yet inexpensive grinders on the market. Electricity to operate the grinder is ideal, but if it is not to be had, several other methods of furnishing power are available. In isolated places, a gas engine can be used, or a hand or sickle grinder which has a train of gears to furnish speed for the stone. The speed of grinders in general requires fittings capable of various adjustments, such as being driven from countershaft, etc.; other assemblies are makeshifts understood best by those who make them. The best arrangement is to attach power and countershafts to the machine. Since its use is now universal, I shall assume all have electric power, and give instructions accordingly. Figure 9, Volume II, shows an improved fixture to be made for grinding wood chisels and the blades of planes, etc. This is to be clamped to the bench

by first removing the tool rest. The angle of the fixture can be adjusted to any degree which suits the purpose and produces the desired result. Between 30 and 45 degrees is the proper amount of bevel required for tools. With this fixture it is possible to grind chisels or blades straight and at right angles. Select a grinding wheel suitable for most work, and include if possible, a number of others, different in size and cutting quality, to be used for the multitude of purposes constantly found for them.

Grade and Grain of Grinding Wheels—The term "grade" as applied to a grinding wheel refers to the tenacity with which the bond holds the cutting particles or abrasive grains in place, and not the hardness of the abrasive. A wheel from which the abrasive grains can be easily dislodged is called "soft" or of "soft grade," and one which holds the grains securely is referred to as a "hard wheel." By varying the amount and composition of the bond, wheels of different grades are obtained. The grades are designated either by letters of the alphabet or numbers, according to the system employed by manufacturers. The letter "M" represents a medium grade, and the successive order of letters preceding the following "M" denotes softer and harder wheels, or vice versa. (This method of grading wheels is not universally a standard system, except among the larger manufacturers.) The grain or coarseness of a wheel is designated by numbers which indicate the number of meshes to the inch through which the grains of the abrasive material will pass. For example, a 36 grain means that the abrasive will pass through a weave having 36 meshes to the linear inch. The method of grading wheels adopted by a number of different manufacturers can be secured from them, as they print these in chart form.

Selection of Wheels for Grinding—The grade and grain to use depends upon the kind of material to be ground, its degree of hardness, and the surface area in contact with the wheel. Theoretically a wheel is of the proper grade when the bond is just hard enough to hold the abrasive until it becomes too dull to cut effectively; then, because of the increased friction, the dull grains are torn out and new points come into action, so that the wheel automatically sharpens itself. The harder the stock being ground, the more quickly the grains are dulled; hence, as a general rule, the harder the material the softer the wheel, and vice versa, altho some very soft materials, such as brass, are ground with a soft wheel which crumbles easily, and does not become loaded or clogged with metal. When a hard wheel is used for grinding hard material, the grains become dulled, but are not dislodged as

rapidly as they should be. Consequently, the periphery of the wheel is worn smooth and becomes glazed, and excessive pressure is required to make the wheel act. Any undue pressure tends to distort the work, and this tendency is increased by the heat generated. If the surface of the wheel becomes loaded with chips and burns the work, even when plenty of water is used, it is too hard. A highly polished surface is sometimes obtained at the expense of accuracy by using hard wheels that require so much pressure to make them grind that the work is distorted. In order to secure accuracy as well as the most economical results, the wheel must cut freely and without perceptible pressure.

I could continue through one or two pages of such advice in the use of the assortment of grinding wheels. Conditions under which wheels are used vary widely, so no definite rule can be given for selecting the proper grade and grain. The beginner's problems are limited in grinding operations, but as his field of activity increases, many simple rituals will be followed from habit, such as always to have at hand a container of clean water for cooling purposes; and he will learn never to grind a tool to greater heat when the color begins to appear without first reducing its temperature to normal by dipping.

Mounting Grinding Wheels—Grinding wheels should not fit tightly on their spindles, nor should they have any play. If a wheel is forced onto the spindle, there is danger of cracking. The diameter of the flanges should be about one-half the wheel diameter (never less than one-third), and they should in all cases be relieved to secure annular bearing at their circumference. The inner flange should be keyed or shrunk on to the spindle. Compressible washers of blotting paper or rubber may be placed between the wheel and the flanges to distribute the clamping pressure evenly, and the flanges should be clamped just tightly enough to hold the wheel firmly. The latter should be carefully inspected, and tapped lightly before mounting to discover cracks. New wheels occasionally burst when first brought to high speed, and those who have witnessed such an accident are usually enthusiastic and thorough in their examination of both wheel and mounting before exposing themselves again to unnecessary danger.

Glazed or Clogged Wheels—A wheel is considered glazed when its cutting surface has become dull and worn down evenly with the bond, which is so hard that the abrasive grains are not dislodged when too dull to cut effectively. Glazing may indicate either that the wheel is too hard for the work, or that its speed is too high. The remedy then for glazing is to decrease the speed or use a

softer wheel. Always keep the wheel true by the use of either a diamond or carborundum stick. As a rule manufacturers of electric grinders make available two wheels, one soft and one hard of the same grade, which when new are perfectly true, and the only satisfactory way to arrive at good results is to keep them in their original condition.

Learn to make use of the tool rest when grinding and always keep it adjusted properly to the wheel, thereby avoiding the danger of getting tools or your fingers caught between the wheel and work. Lastly have a guard over the wheel for protection to face and eyes in case the wheel should burst and set in action flying particles imbued with terrific momentum imparted through centrifugal force.

Laps and Lapping—The gunsmith is often called upon for such work as lapping special dies to size: lapping chambers, ring gauges, plug gauges, special test gauges, snap gauges, barrel plugs, etc. Figure 42 shows a set of lap arbors with the same

taper as the taper-pin reamers— $\frac{1}{4}$ inch to the foot. These are used for internal work, such as lapping ring gauges or any other work requiring a straight hole. Laps are usually made of soft cast-iron which makes it possible to produce a better finish. Whatever material is used, the lap should be softer than the work, otherwise the latter will become charged with abrasive and cut the lap. The order of the operation would then be reversed.

All laps for die work used at the Arsenal, when I was stationed there, were made of pure lead, as it was inexpensive and gave fine results. The arbor for the lap was made of cold-drawn steel with grooves to hold the lead, which prevented it from turning when the lap was slightly smaller than the hole and ceased to cut. The lead was expanded on the end, and this was repeated a number of times. Other laps were cast from pure lead and turned to the required size for the different draw dies, and these were used continuously for a number of days by the operators.

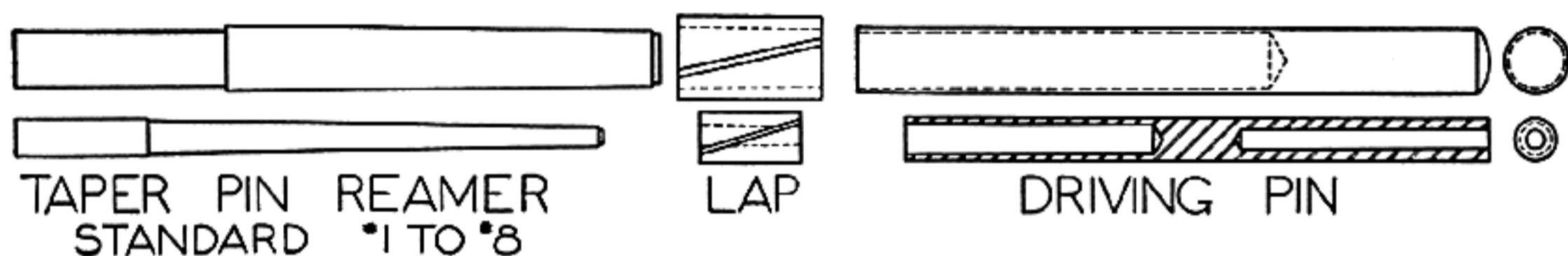

Fig. 42

Internal lap, arbors, and driving pin. If much lapping is to be done, a full set should be made

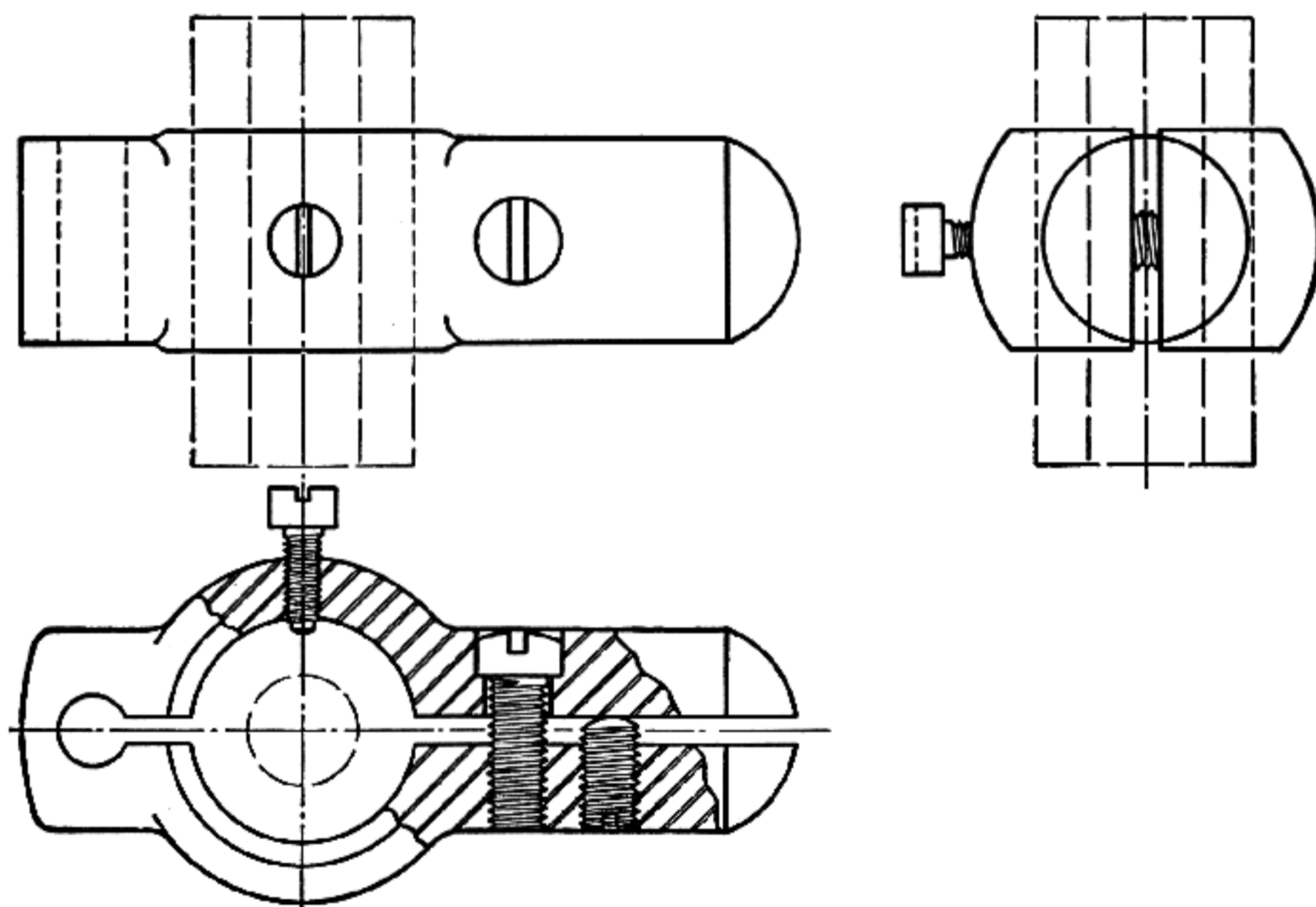

Fig. 43
External lap holder

External laps are used in the form of a ring with an outer band or holder and an inner shell, which forms the lap proper, made of copper, cast-iron or brass. The lap is split and screws are provided in the holder for adjustment. Length of an external lap should be at least equal to the length of the work; a little longer does no harm. Figure 43 illustrates one of these.

Grading Abrasives for Lapping—For high-grade lapping, abrasives may be evenly graded as follows: a quantity of flour emery or like abrasive is placed in a heavy cloth bag which when gently tapped causes fine particles to be sifted through. After a sufficient quantity has been obtained it is mixed in a dish with sperm or olive oil. The larger particles will sink to the bottom in about one hour and the oil should then be decanted into another dish. Be careful not to disturb the sediment at the bottom. The oil is allowed to stand for several hours longer, after which it is poured again, and so on until the desired grade is obtained.

Charging Laps—To charge a copper or cast-iron lap, spread a little of the prepared abrasive over the lap and roll it between two hardened steel blocks; do not rub, but roll the lap with even pressure. On laps for external work, a hardened steel plug smaller than the hole should be used to roll the abrasive into the ring. For breaking, when there is a considerable amount of material left on the gauge, I mix coarser emery with sperm oil, charging and using the copper lap with it until there are only two to three ten-thousandths left to finish with the finer specially prepared abrasive. When a lap is once charged it should be used without applying more abrasive until it no longer cuts. If a lap is overcharged with abrasive, a rolling action between the lap and work takes place, which results in uneven distribution. A properly charged lap should never develop bright spots. On the contrary, the surface should be a uniform gray. Use plenty of sperm or olive oil to wash the fine steel cuttings away from the lap, keeping the same

adjusted to prevent the work from becoming bell-mouthed.

Dry Lapping—Use the finest optical emery by lightly sprinkling it over the fast-revolving lap; wash off with gasoline and test for size often. To finish, use powdered rouge in the same manner; when completed you have one of the most highly finished surfaces possible.

Laps for Flat Surfaces—Laps for plane surfaces are made from cast-iron and lead. Figure 44 illustrates a small cast-iron lap for small work. In order to secure the most accurate results, the lapping surface must be a true plane. On the cast-iron lap the surface is checked or scored by narrow grooves located between $\frac{3}{8}$ and $\frac{1}{2}$ inch apart across the full length of the plate, forming a series of diamonds as on a stock. The lead lap is constructed in the same manner except for the grooves, its surface being a true plane. The latter is used as a roughing lap and the cast-iron one for finer finishes. After a lap is charged, all loose abrasive should be washed off with gasoline to determine if the surface has a gray appearance. Repeat until all bright spots are charged, if this is not the case. When lapping, the surface should be kept moist with kerosene; gasoline will cause the lap to cut a little faster, but it evaporates so rapidly that the surface becomes glossy in spots. Loose emery should never be applied while lapping, for if well-charged with the fine abrasive in the beginning, kept well-moistened with kerosene, and not crowded too much, it will last a long time. The pressure applied to the work should be just enough to insure uninterrupted contact. A lap can be made to cut just so fast, but with too great pressure it will strip in spots. The causes of scratches on the work are: loose abrasive on the lap, too much pressure, or poorly graded abrasive.

Diamond Laps—I use diamond laps and diamond dust extensively, especially on very fine holes, charging laps for lapping the spindles of anvils of micrometers, and charging cast-iron lapping plates

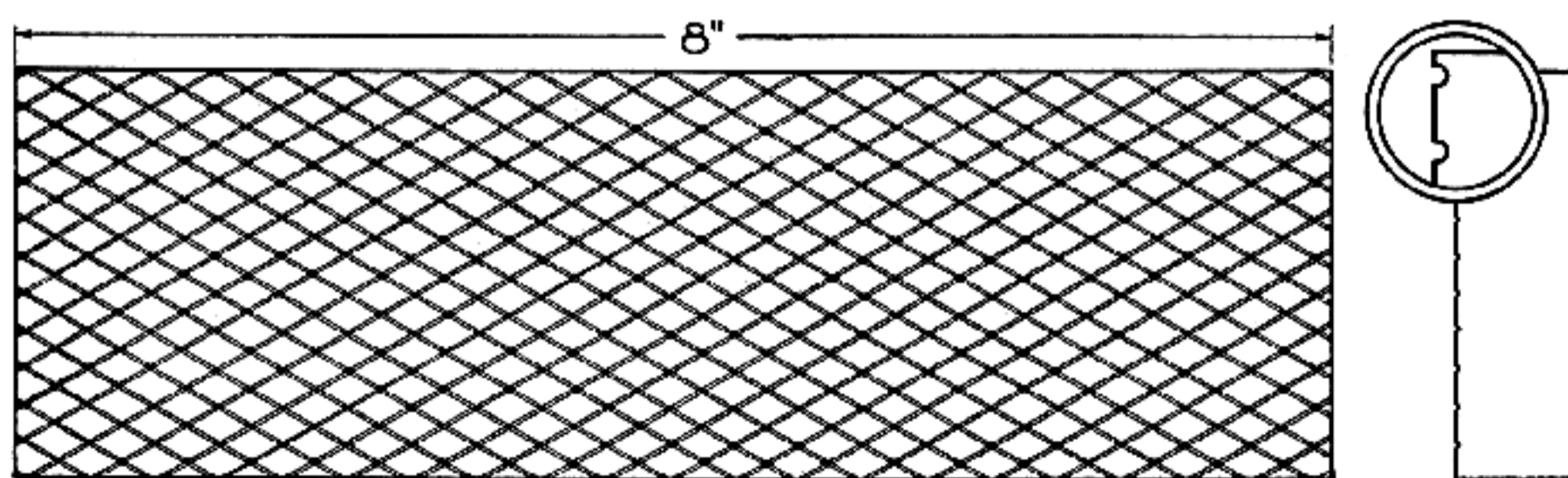

Fig. 44
Cast-iron lapping plate. Made in various sizes to suit requirements

to this condition, will last for years, provided you exercise reasonable care in its use.

All reamers are ground lengthwise in a special tool grinder made for them, and, like wood-working tools, they must first be put into sharp condition before reliable work can be expected. All reamers when new are up to size or three to four ten-thousandths over. Copper-plate each flute, and with a medium or fine $\frac{1}{2}$ -inch oilstone, stone the flutes up to cutting edge by starting from the rearmost portion. If you are experienced in the stoning process, it is possible to stone lengthwise, an operation in which the high points left by the grinding wheel are immediately discovered. They must be stoned until the flute has a bright evenly polished surface, at the same time retaining size. To avoid a chattered hole, see that each flute cuts, with the others, an equal amount of chips. Particularly with tapered reamers is it more or less common to encounter chatter, which, naturally, is fatal to a satisfactory recess. Important to remember is—never chuck a hand reamer in a lathe or drill press, as hand reamers are made to ream by hand only; the same may be said for taper-pin reamers. Machine reamers are specially made; included in this type are the taper-pin reamers. It is a grave mistake to allow more than three to five thousandths of stock for the reamer to remove. When a rough drilled hole is encountered it does require more stock. A clean-bored hole need have only two or three thousandths of metal to be finish-reamed.

Screw-drivers and Bits—This subject has been more or less neglected, because every one looks upon a screw-driver as a tool intended either to remove a screw or to place one in position. On gun work, owing to the screw slots being much smaller than the standard recommended by manufacturers, the quality of the screw-driver is of major importance. It would be impossible to picture a high-grade shotgun made with screw slots from .025 inch wide for $\frac{1}{16}$ screw to .057-inch width for a $\frac{1}{4}$ -inch screw; they would look and be entirely out of proportion. For this reason the makers have adopted small-slotted screw heads for both rifles and shotguns. In order that the gunsmith can cope with this situation he must have screw-drivers constructed in a way quite different from that of the ones usually purchased in a hardware store. The latter are, as a rule, made only from cheap material; and when ground to fit a gun screw, they twist out and mar the head, a fault which is inexcusable even in an inexpensive arm.

Figure 21 will show the correct way to shape screw-drivers for gunsmithing purposes; unless the bit fits the slot in every dimension, there results,

as just mentioned, a distorted or damaged head. This fact makes it imperative, for really fine work, to have a driver for every slot size.

In attempting to remove a tightly imbedded screw that does not yield to ordinary effort, I obtain the best results with correctly sized driver bits that fit a brace, exerting steady pressure on the brace with the left hand, and with the right gently turning the screw out. This method will start any screw no matter how firmly set, and may also be employed to seat them tightly. Have you ever noticed that on a high-grade gun, resting on its butt plate, all slots point in the same direction, north and south, according to the points of the compass on the map? Well, it's true, and the same applies, in a continued line, to the butt-plate screws. Any other arrangement is considered unsightly and a detraction, marking the difference between precision and indifference. Be as particular in the care of good screw-drivers as of any other valued tool by refusing to submit them indiscriminately to the grinding wheel for every odd-sized screw, but rather have a generous selection, well filed, tempered, made from the best spring steel or drill rod, and fitted to serviceable handles.

Soldering—Years of experience in this line have led me to believe that nine out of ten men who have occasion to resort to this art could still, with advantage to their work, improve their technique. Soldering is sometimes erroneously referred to as "sweating," but there is a vast difference in strength between a well fitted and sweated union and one soldered in the ordinary way. An important point, frequently overlooked, is the proper cleaning of surfaces to be joined, and this operation is too often left for the flux to correct. While nearly all metals can be joined by use of the same flux, a proper selection is at times necessary. The result following improper preparation and cleaning overshadows in every instance the effects of good soldering and is particularly noticeable in gun work. For strength, adapt the parts to one another perfectly, because the more accurate the fitting, the stronger the union. Use a solder with as high a melting point as possible. The temperature of the work to be joined should be brought as near as possible to the melting point of the solder to insure better fusion and flow.

There are a number of fluxes or soldering salts on the market that are satisfactory. Their action in soldering is to remove and prevent the formation of oxids during the operation, to allow the solder to flow freely, and to unite firmly the surfaces to be joined.

For sheet tin, rosin or colophony may be used,

but owing to the ease and rapidity of applying, a solution of zinc chlorid (zinc dissolved in HCl) is more generally employed. Beeswax or tallow can be used, and so can almost any of the pastes, fats, or liquids prepared for that purpose.

For lead, a flux of almost any oil and rosin in equal parts is satisfactory.

Lead burning, now almost a lost art, is a different operation from soldering. Here the surfaces must be bright and free from all oxid, while instead of solder, which is tin and lead, the operation is done with pure lead, rosin and oil.

Fluxes—Hydrochloric acid, rosin, turpentine, tallow, and especially chlorid of zinc or soldering liquid, are among the common fluxes used in soldering. For a complete list see Chapter XXVI.

A very good acid mixture for cleaning work to be soldered is equal parts nitric and sulfuric acid and water. *Never pour the water into the acid!*

By laying a piece of tin foil, covered on both sides with a flux, between two perfectly fitted and clamped parts and heating until the foil is melted, a satisfactory union is effected. This is very good in joining broken parts of brass and bronze work. If their apposition is good, they can be joined in this manner so that the joint is not only strong, but almost imperceptible.

A solution of copper for copper-plating steel or cast-iron before soldering is easily made and applied. It is identical with the one recommended for coppering the flutes of reamers before stoning, and is composed of copper sulfate $3\frac{1}{2}$ ounces, sulfuric acid $3\frac{1}{2}$ ounces, distilled water 1 gallon. Dissolve the copper sulfate in water and add the acid.

The best solder for gun work such as soldering ramps, rear-sight bases, sling-swivel bases, etc., is 75 per cent lead and 25 per cent tin, which has a melting point of 482 degrees Fahrenheit. Solder having a low melting point is not recommended for gun work because of the heat a rifle or shotgun is subject to in rapid fire. The tropical sun of Africa has been known to melt off soldered parts of firearms where no attention was given to this feature.

The soldering copper for ordinary use should be about $1\frac{1}{2}$ pounds in weight, length $2\frac{1}{2}$ to 3 inches, octagonal in form, and pyramidal point with square edges. It should be fixed to a straight or angulated iron rod about 8 inches long with an ample wooden handle. When heating for use, the best way to ascertain correct temperature is to hold it near the face. By virtue of heat emanation one soon learns to know if the copper is heated to the right degree, and if a bright warm glow is felt, it is hot enough for use.

Taps and Tapping—When the amateur first finds use for taps he is likely to become discouraged, since most tapping troubles are caused by the use of drills that are too small in diameter. Tap drill sizes made specially for machine screws should be varied according to the material to be tapped and the depth of the tapped hole. Soft, tough material such as copper, Norway iron, stainless steel, aluminum, etc., should have a larger hole for the tap than harder metals. If the recess is a trifle too small when tapping soft material, the thread is in danger of being torn off, the effectiveness of the thread depth is decreased, and is not nearly as perfect as it would have been had the tap drill been larger. When tapping soft material, the metal at the top of the thread is somewhat drawn, thereby increasing the depth of the threads, particularly if the keen edge of the tap has been dulled from use.

For the beginner it is best to check from a table of double depth of threads. As an illustration, suppose we wish to tap for a 6 x 48 screw which is a U. S. standard form of thread. Let us turn to the table of double depths of thread, where it will be observed that for a number 6 tap measuring .138 inch in diameter, .027 is double depth of a 48 thread. But because the metal expands as a tap is used in a hole, we can drill a hole only 75 per cent of that depth of thread. Therefore the correct drill would measure 0.111 inch; this being too small we must select a size larger, which must measure 0.120. The nearest drill to that size is selected, which is #31. When only a shallow hole is to be tapped, two drills are needed—one for starting and one for bottoming. The latter may be accomplished by use of a drill ground off square at point, or a flat-bottom drill, originally constructed for the purpose, permitting installation of the greatest number of threads. In the use of small taps, be particular to grind them with the correct leed, which is the cutting point of the tap. Most taps are furnished with a correctly ground leed, but after they become dulled, it is necessary to grind the end back and regrind the leed. Before grinding a tap, study a new one for the purpose of learning how the manufacturer first ground the leed, and follow that pattern. Even the best mechanics are inclined to grind too much clearance, which causes a tap to break easily. Satisfactory results are obtained only when using a tap wrench, proceeding slowly with small taps, and never trying to complete a full turn of the tap. The secret of success is to back it out a good half-turn, starting again slowly, for taps are brittle and easily broken. If you are conscious that a tap springs in the least, reverse and start over.

To Remove a Broken Tap—When broken near the surface it is an easy matter to remove it by

driving on both sides with a round punch, ground in the form of a round-nose chisel. Two persons can do this much better than one by striking light blows; when they are striking evenly the force of the blows can be increased as may be required. By driving on both sides, the tap is not wedged against one side of the hole as when using a single drift, but is forced to turn out. This is an old method, and one of the first I was taught.

Another method, which has proven a life-saver many times, is to inject into a hole a little nitric acid, diluted in the proportion of one part acid to three parts water. The action of the acid upon the broken part and steel loosens the tap so that it can be removed easily. The remaining acid should be washed out so it will not destroy the threads in the steel, which then should be coated freely with oil.

Lubricants for Tapping—The breaking of a tap is caused by: improper lubrication, the tap not being square with the hole, ignorance, or carelessness. Frequency of this misfortune can be reduced greatly by proper lubrication alone. Ranking first and best among the greases I use is a mixture of white lead and sperm oil. Another reliable combination is 10-per-cent graphite, 30-per-cent tallow, 40-per-cent white lead, and 20-per-cent sperm oil. Machine and lard oil class with the poorest of lubricants for tapping; however, they are probably used more extensively than either of the two good formulas just mentioned. When tapping in cast iron, a small amount of kerosene helps materially. In high-power firearms a full, fine, smooth thread is imperative to obviate the dangers of the sudden, violent, and repeated shocks, which have a cumulative effect upon every part of the mechanism.

Makeshift Taps—I have often made a tap by threading a piece of steel in a lathe or with a die, filing three flutes in the end, then backing off the clearance, and after hardening and tempering I had a tool that lasted for many operations. If the need is urgent, file a flat on the end, on a taper; then remove a small segment of the remaining arc, constructing thereby a cutting edge; harden and temper and finish the hole with this. You will find very often in gun work that the manufacturer has not used a standard screw or thread and it will be necessary to ease out a tapped hole for just one particular screw. A tap made in the above manner has a considerable amount of clearance, answers the purpose nicely, and is not easily broken. When it becomes dull, all that is necessary is to grind the face or flat; if it should then cut too large, narrow the face by further grinding.

Turning Tools and Tool Grinding—Turning tools are of varied shapes adaptable to the many

different purposes they are intended for. There are certain principles governing the form of turning tools which apply generally. When grinding lathe tools or any other turning tools there are three points to remember: first, the cutting edge of the tool as viewed from the top must have a specific shape or contour; second, there must be a certain amount of clearance below or behind the cutting edge; and third, tools are given a backward shape, so to speak, and a side slope, or a combination of the two on the part against which the chip bears when the tool is in use. However, experience is our best teacher in the different ways of grinding lathe tools. It is much more economical to buy the $\frac{5}{16}$ standard high-speed tool bits and an Armstrong tool holder than forged tools. These are designated by different names, such as parting, thread, side, turning or round nose, boring, etc. The shape when viewed from the top is suggestive of other uses than plain cylindrical turning. The exact form can be best determined under working conditions. This is illustrated by reference to the parting tool which is used for cutting grooves and parting work at given intervals over specified distances. Naturally it must be widest at the cutting edge to prevent binding while feeding into the work.

Aside from the contour, in relation to the cutting edge, there remains to be determined the proper clearance, amount, and direction of the slope of the top of the tool. The word "top" is used to designate that surface against which the chips bear when severed from the work. For most tools it should slope away from what is the working part of the cutting edge and be set a trifle above center. To use this type in turning a diameter of, say $\frac{1}{16}$ of an inch, it would be impracticable; so we grind one with a more pronounced point and greater clearance at the top. On small work the metal must be removed with an even free cutting effect. In thread tools the clearance must be less decided, but for really good work it is advisable to stone the point on center. If the reader familiarizes himself with the above he will at least have a working basis to start from; but, as already stated, success will be commensurate with the amount of painstaking practise which has been expended.

ACCESSORIES

Alcohol Lamp and Bunsen Burner—An alcohol lamp or, when gas is available, a Bunsen burner, is almost indispensable to the gunsmith. Let us suppose a small bent trigger spring is to be made. It can be formed by resorting to a small piece of discarded watch spring, heating it over the lamp or burner until blue, then with snips or hand

shears, cutting it to the required width. Heat again in the flame of the burner or lamp, and with a pair of pliers bend to shape. It is not always necessary to temper these springs, but when they are heated until red and hardened in oil, draw the temper to suit. This operation can be done without moving from the bench, much more quickly, and certainly better, than it could be done at a forge or with a gasoline torch.

The advantages of the alcohol lamp and Bunsen burner over the forge or furnace are: they draw temper on small parts evenly; the temper colors can be readily seen, as the flame of alcohol or gas makes no smoke to obscure it; they are convenient for small tempering such as taps, small screws, special drills, bending small files to odd shapes; and they are indispensable in laboratory work. Figure 45 illustrates the burners used by gunmakers.

Emery Paper and Cloth—The finer grades of French and Turkish paper for exquisite finishes should be on hand and used after the polishing process by the cloth. Never destroy the cloth, as

employment of a finer. When using the finest emery cloth, moisten the surface with sperm oil for a fine, soft-appearing polish; to bring the finish to a high luster, use fine French paper without oil, completing with crocus cloth. To use emery paper or cloth in a lathe, run on high speed and hold the cloth on a flat file. When holding emery cloth by hand for polishing fast-revolving round pieces, care must be taken that the hand does not get caught in the cloth, as at times it clings to the work, thereby causing a serious injury.

Forge and Anvils—These are possibly not used as frequently as other tools, yet they are extremely important and desirable as part of any shop equipment, especially that of the gunsmith. The forge may be of the regular forge design, gas furnace, or gasoline blow torch. The latter is only used in emergency, when a proper forge or furnace is not available. Suitable anvil and small blacksmith tongs to handle the work should be included. It is said that the quality of an anvil can be judged by the ring. At any rate a good anvil gives out a clear sharp sound when struck by a hammer, and

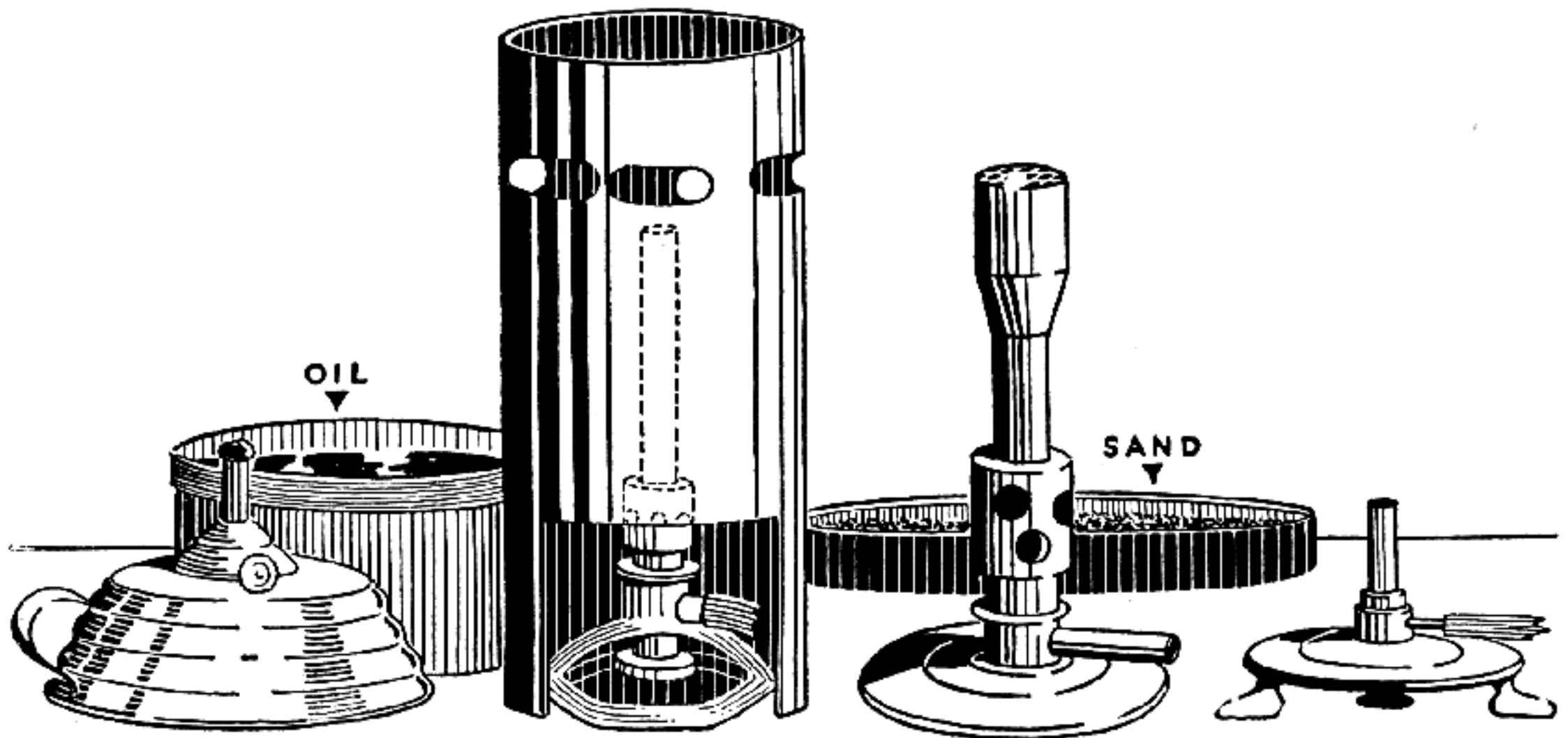

Fig. 45

Bench burners and equipment customarily used for hardening and tempering small parts

this is useful in one way or another until devoid of all abrasive. There are a number of different grades of the latter, from FF to #40. Cut or tear the sheets into convenient pieces for the work to be done. When using the cloth on work where file marks show, first use a coarser grade by folding it around a file, which is then applied in the customary manner. Be careful to remove all marks and scratches left by the previous grade before the

if soft or defective the tone is dull and unmusical. A perfect anvil so mounted that it gives out a volume of sound is much easier to work on than one having a dead ring. They vary in weight from 50 to 300 pounds, but for the gunsmith an anvil weighing between 60 and 100 pounds is adequate. It is necessary to strap it to a block to insure stability. Its height should be such that when standing beside it one's knuckles will just reach the top surface. A

solid oak block set endwise in the ground makes a good foundation, but for the small shop a cast-iron support serves as well. An anvil should never be strapped rigidly to its foundation, as this checks the vibration which tends to keep its face free from scale.

The square hole in the face for receiving the cutting and forming tools is called a "hardie hole," the small round hole near it, the "pritchel hole," and the pointed end, the "horn." Anvils are usually made with a wrought-iron body to which is welded a hardened steel face.

When hand forging, two qualities of heat figure in the operation. If the object is merely a drawing out or surface smoothing, the "cherry-red heat" is called for. The work of drawing out or smoothing is performed by striking lightly and evenly with a hammer until the desired result is secured. A like degree of heat is employed where closing the structure of the steel is the object to be attained, but in this case the blows of the hammer should be heavier. If the forging is to embrace a material change in shape, the rate of heat must be increased. A gunsmith rarely needs a sledge hammer, as the material he works with is not of a size to warrant a tool of that weight.

Micrometer and Its Use—This is the instrument of precision *par excellence* for the gunsmith, without which his activities are like those of a mariner at sea deprived of compass and sextant. It furnishes a constant means for checking screws, pins, drills, drill rod, bullets, and a thousand and one other things. To read a micrometer, count the number of whole divisions visible on the scale or spindle, multiply this number by 25 (the number of thousandths of an inch that each division represents) and add to the product the number of that division on the thimble or barrel which coincides with the axial zero line on the frame. The result will be the diameter expressed in thousandths of an inch. As the numbers 1, 2, 3, etc.—opposite every fourth subdivision on the spindle—indicate hundred-thousandths, the reading can then easily be taken mentally.

Suppose the thimble or barrel were screwed out so that graduation 3 and two additional subdivisions were visible, and the graduation 10 on the barrel or thimble coincided with the axial line on the spindle. The reading then would be 0.300 plus 0.50 plus 0.01 or 0.360 inch. Some micrometers have a vernier scale on the side of the spindle in addition to the regular graduation so the measurements within 0.0001 part of an inch can be taken. (This sort of micrometer I consult for reference, and use a plain micrometer for what I call rough

work.) Micrometers of this type are read as follows: first determine the number of thousandths as on an ordinary micrometer, and then find a line on the vernier scale that exactly coincides with one on the thimble or barrel. The number of this line represents the number of ten-thousandths to be added to the number of thousandths obtained by the regular graduation. The reading would be expressed as follows: Suppose the barrel were screwed out so that graduations 4 and one additional subdivision were visible and the graduation 15 on the barrel came over the line half-way, so the reading would be 0.400, 0.025, plus 0.015, plus 0.0005, or 0.4405, as 23 would coincide with 5 on the spindle.

A micrometer to the amateur is a novelty and he usually makes a plaything of it at first, measuring everything with which he comes in contact, from the hairs on his head to the whiskers of the cat.

Oilstones—These embrace a large variety of shapes and sizes applicable to such work as stoning reamers and actions, sharpening small drills, relief on taps, all cutting tools, etc. The natural oilstones most commonly used are the India and Arkansas. The Washita is a coarser and more rapid-cutting stone than the Arkansas, and is used mostly for sharpening wood-working tools. There are various grades of Washita which vary from the perfect crystallized and porous whetstone grit to vitreous flint and hard sandstone. The sharpness of the grit of any Washita stone depends entirely upon the character of its crystallization. The best whetstones are porous and uniform in texture, and are composed entirely of silica crystals. The poorer grades are less porous, making them vitreous or glassy, and may have hard spots or sand holes or contain grains of sand among the crystals. For general work a soft, free-grit, quick-cutting stone is required, altho a fine-grit medium hard stone is sometimes preferred. Some Washita stones are white, while others are streaked more or less with a yellow or red tinge. They are found in the spurs of the Ozark mountains of Arkansas. The Arkansas stone is harder, more translucent, and of greater density than the Washita. It has an exceedingly sharp grit, and will cut as well as polish very hard metals, such as high-speed steel tools and reamers. The Arkansas stone is used more frequently in gun work than the Washita to produce the fine cutting edge required on chambering tools, etc.

Artificial stones are made in a multitude of shapes and sizes and are adapted for sharpening all kinds of tools. Such stones are made by the Norton Company of alundum and crystolon, the former being known as India oilstone and the latter as crystolon sharpening stones. Similar shapes are

manufactured by the American Emery Works, and The Carborundum Company, which makes them in a great variety.

They are supplied in three grades or grits: coarse, medium, and fine; the coarser ones are used to rough out work or sharpen extremely dull or nicked tools, etc., while for sharpening carpenters' tools and as a general purpose stone, the medium variety is selected.

Fine Arkansas stones are best adapted to the finishing of reamers, particular cutting tools, etc.

How to Care for Oilstones—Like all other tools an oilstone can be ruined by abuse and lack of care. There are three axioms to be remembered in the care of an oilstone: first, to retain the original life and sharpness of its grit; second, to keep its surface flat and even; third, to prevent its glazing.

To retain the original freshness of the stone it should be kept clean and lightly covered with oil. To let an oilstone remain dry for long, or exposed to the air, tends to harden it. A new natural stone should be soaked in oil several days before being used. If in a dry place, it should be kept in a box with a closed cover, and a few drops of fresh clean oil left on it, preferably sperm oil.

Tools should be sharpened on the edges of a stone as well as in the middle to prevent it from being worn down unevenly, and it should be turned end for end occasionally.

To restore a flat even surface, secure a cast-iron plate having a true surface and sprinkle loose emery mixed with water or gasoline on it. Place the oilstone upon the plate and grind it true by either a circular or back and forth motion, but hold the stone in center so it will grind evenly all over. This method is adapted to all grades, but stones of special shape may be reformed by planing a groove corresponding to the shape of the stone in a cast-iron plate and drawing the stone through the groove, using water or gasoline and emery as just described. #90 or 100 emery is the best for this operation.

To prevent an oilstone from glazing requires the proper use of oil and kerosene. The purpose of using either oil or kerosene on a sharpening stone is to float the particles of steel that are cut away from the tool, thus preventing them from filling in between the crystals and causing the stone to glaze.

On medium and fine-grained natural stones and in all artificial stones, oil should always be used, as kerosene is not thick enough to keep the steel out of the pores.

To further prevent glazing, the soiled oil should be wiped off as soon as possible after use. This is important, for if allowed to remain, the oil dries into the texture and carries the steel dust with it. If the stone does become glazed or gummed, a good cleaning with gasoline will restore its cutting qualities. If not, scour with loose emery or sandpaper fastened to a perfectly smooth board. Never use turpentine on an oilstone for any purpose!

Sandpaper — This is furnished in grades ranging from #3 to 7/0. The latter is the finest grade and is used only for the finishing operation on stocks or other wood work. To use sandpaper properly, fold it, after cutting to desired size, around soft rubber or cork $1\frac{1}{4}$ by $2\frac{1}{2}$ by 4 inches, which makes a convenient and very efficient hand hold. The flexible cork or rubber follows a curve much better than if the holder were solid. When a large flat surface is encountered, or one just a little irregular, make a holder from leather and thin strips of wood. A large amount of space can be covered by this device much more thoroughly than any method I am acquainted with. For reducing the size of rubber recoil pads, sandpaper or emery cloth glued to wooden discs for attachment to a grinder spindle is invaluable. A good investment is to have a generous supply on hand embracing a wide range in grades, as its uses are many and it fills a need that can be replaced by no other accessory.

CHAPTER V

Reading and Making Drawings

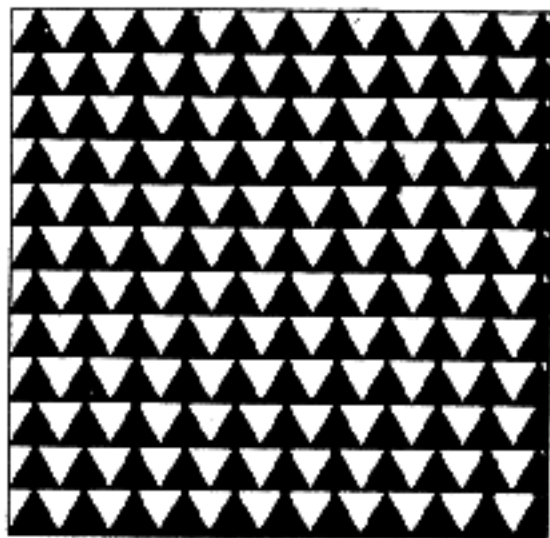

Reading and Making Drawings

AN UNUSUALLY large number of shop drawings have been used to illustrate the two volumes I am presenting on gunsmithing, especially the second. I realize that a number of these books are going to be placed in the hands of men not trained in the mechanical arts, and they should have an idea of the things the pictures represent. The drawings have been reduced from a tracing measuring 22 x 36 inches and larger down to the required page size of the book, consequently the reader may not be able to decipher many small figures and letters without the use of his magnifying glass. To be able to read a blueprint or drawing is as essential to the beginner's success as to be able to read the printed matter between the covers. To read the drawings we should know some of the principles of making them. These will be explained as concisely as possible according to the space permitted. The reader should first understand that a drawing is a record of instruction given him to read; secondly, he should realize that the language used by an engineer in making his drawings is largely a language of lines, and that unless he knows how to read lines, the instructions recorded on the drawings are written in a foreign tongue.

Study the several views until you have a good mental picture of what is to be constructed. A drawing is a flat surface, and, as with a map, it is necessary for the reader to use his imagination to make the lines and views rise from the paper. When a clear-cut mental picture has been formed, the dimensions should be studied until understood. Next, all the lettered text should be read and carefully considered. Carelessness in any one of these three respects is inexcusable.

A drawing is, in a sense, a picture made up of views; for example, front view, top view, end views, etc. These views are made up of lines which would show clearly to the eye if the part, accessory, machine or fixture were viewed from the several positions noted. A front view consists of those lines which would be clearly seen if the observer were viewing the part or fixture from the front. The drawing should also contain all the essential dimensions and indicate clearly from what surface they are to be taken. In most instances, a distinct

arrowhead with the point resting against the line represents the surface or outline from which the measurement starts, or from the work line which represents a surface edge and has been lengthened to make it convenient for placing the arrowhead. Another arrowhead is placed against the line representing the surface where the measurement stops; the arrowheads are connected by a line called a dimension line, and the given dimension is placed either in this line or directly over it. The drawing will probably also contain lettered directions: some are to be ground, and the words "precision grind" or the letters *PG* may appear on those surfaces; others are to be finished, and on these the letter *F* may be used, etc. Figure 46 illustrates the manner in which a part is viewed.

Many of the drawings in the books are mere projection drawings with which a single idea is meant to be conveyed. To understand thoroughly what the term "projection" means, study the action of light upon an object. Take as an example a street car along the street; our view of that car is made possible by the fact that light is reflected from it into our eyes. This is true of all objects which we view, and we say that we see the car or object. In other words, the light which is thrown back from the car into our eyes gives us a view of the car. If the car or object faces toward us we get a front view, if away, a rear view. While the object itself is not a source of light, it is so treated in viewing it, and the light is said to be projecting from the object viewed. When a view drawing is made, it is often known as a projection of an ordinary (part) without any dimension. These drawings are merely a means of conveying to the reader an idea of the part; later it will be found necessary to work out the details.

It would be well for every reader interested in this work to make good mechanical drawings, for with the ability to make drawings would come the ability to interpret them. But there are often many reasons why this is not possible, and it is with the idea of giving the requisite amount of knowledge and practise in visualizing the finished product from plans, elevations, and sections that this chapter has been prepared, for it will explain more to the mechanically trained man than I could

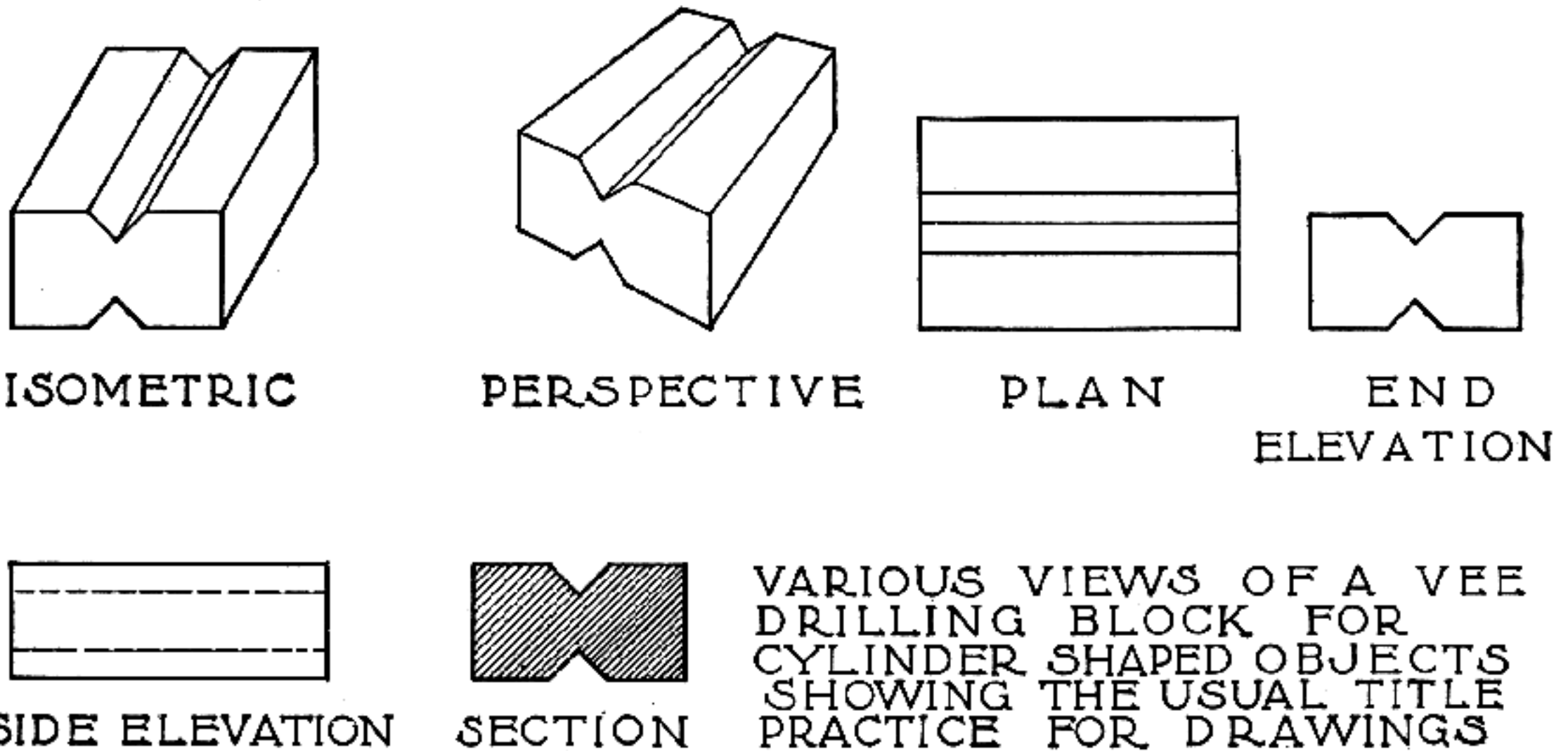

Fig. 46

Illustrating different views of an object in mechanical engineering

ever explain in writing. With a careful study of the drawings herein will come the ability to "read" one of these complicated drawings like the rest of the book; it is interesting to translate every shade of meaning intended by the designer and thus be able to carry out the work in an accurate, efficient, and craftsman-like manner.

These drawings were first sketched freehand as each chapter was written and then handed to engineers or draftsmen skilled in the art of mechanical drawing. These men first had to lay the foundation for the more advanced work by learning the kind of equipment necessary. They had to train their eyes to visualize the objects which I had drawn freehand and which only expressed the general meaning. In visualizing these objects it was necessary to measure distances, to draw with precision lines of uniform width and accurate direction. It was necessary for them to learn the rules of geometric construction, the method of representing plans, the elevations of objects, and the principles of orthographic, isometric projections and profile work.

Even tho a great reduction has been made from the original linen tracing, the reader can read every detail distinctly. If he should wish a reproduction (a blueprint) from these original drawings, I have made arrangements with the publisher, so that it will be possible to obtain such reproductions at a reasonable cost. The full-page drawings in these books are 22 x 36 inches, the half-page are 22 x 18 inches, and others in proportion. A blueprint, as used by engineers and by mechanics in the various industries, is a reproduction of what

is known as a "working drawing." A working drawing, made from the tracing, shows by means of lines what the piece, part, or fixture is, on the full scale, and gives the necessary working dimensions or whatever other data the machinist needs to know in order to build the piece or the part. In other words, it is the drawing by which the workman does his work and to which he looks for his information. However, it is essential that the tracing itself be preserved for reference and therefore a blueprint is made from the tracing; this will be what the reader uses in his shop. The lines, numerals and letters on the original tracing or drawing are black on a linen background, but these appear on a blueprint as white lines on a blue background; hence the name "blueprint."

The importance of having large-size blueprints to work from, is that they simplify the reading or solving of the problem before the student. It is well also for him to understand that his large blueprint is a real and exact reproduction of the drawing shown in the book, that it is usually drawn to scale or larger, and that, if he implicitly follows instructions and dimensions as given in the blueprint, he is fortified in any argument which may occur over his work. If his work checks up with the blueprint, he is assured that there is no possibility of error.

Sectional Lines — In addition to the working lines and the dimension lines on the drawing views, the reader will, in some cases, find a series of parallel lines drawn closely together at an angle to the working lines of the view. These are known as

to finish burnishing reamers, etc. Diamond dust may be purchased, and its preparation as a lapping abrasive is simple. The diamond after being crushed to powder in a mortar is mixed with a high-grade olive oil. The mixture is allowed to stand five minutes, after which the oil is poured into another glass. The coarse sediment left is removed and labeled #0 for future differentiation. The oil poured from #0 is stirred, allowed to stand ten minutes, and is then poured into a separate glass; the sediment remaining is labeled #1. This operation is repeated until all the dust has been recovered from the oil. The time that the oil is allowed to stand is increased from 10 minutes to 10 hours for the #6 operation, and even longer or until it becomes clear. #0 or coarse diamond is washed in benzine and recrushed unless this coarse dust is required for some particular grinding operation. To the gunsmith the intelligent use of abrasives is an invaluable aid. It finds its most important expression in lapping shotgun barrels for increase of pattern, removal of pits or tool marks, as a final finish to rifling that adds the highest refinement in accuracy, etc. It is also the only practical means of evenly removing coatings of rust, provided this has not already worked its destructive process too deeply into the texture of the metal.

Lapping Chambers in Shotguns and Rifles—This feature will be explained more technically in a separate chapter. It would be well, however, because knowledge of the subject is so desirable, for the beginner to work on test pieces to gain experience. As an example, in a piece of steel, say $1\frac{1}{2}$ inches thick, drill a $\frac{9}{32}$ hole and stone the cutting edge of a $\frac{19}{64}$ drill to a small radius, using this as a reamer for finishing. Then harden and remove the strain in the steel by passing it back and forth in the fire until unable to touch it without burning the hand. Let cool. Make a plug gauge to measure .298 inch in diameter from a piece of drill rod; it is not necessary to harden the gauge. Then construct a lap from a piece of $\frac{5}{16}$ -inch brass, the same size as the hole, 5 inches in length. Undercut it back 1 inch from the end long enough to pass through the hole. With a hack-saw, split in the center, back $1\frac{1}{4}$ to $1\frac{1}{2}$ inch, and spring it apart. Now start the lapping operation by either chucking the lap or the piece to be lapped. If same is chucked in a lathe, place a lathe-dog on the lap in order to hold firmly. Mix flour of emery with sperm oil until it forms a paste, and with a small piece of wood for an applicator, place what would be considered a reasonable quantity on the lap, and start the machine. Draw the lap gently back and forth from one end of the hole to the other, being sure to supply a sufficient amount of emery and

oil to insure cutting, the machine meanwhile revolving at a moderate rate of speed. After a short trial cut, depending on how much stock must be removed, wash out the hole with gasoline, and check progress with the plug to see how close it measures. Continue until you are just able to pass the gauge through the hole. In this form of lap the ends are more or less bell-mouthed; nevertheless, you have accomplished a lapping operation with a form of lap that is used very often for jobs that do not require close precision work. For perfect diameters the standard lap arbor and copper or cast-iron laps are used, for the reason that their construction permits delicate expansion and proper charging.

When dealing with a taper hole it is necessary to make a cast-iron lap of the same taper as the hole on a straight mandrel or arbor. The lap proper is only a shell with a pin through it and the mandrel to hold it in place, but small enough on the pin so the lap can work freely during its performance.

Reamers and Their Uses—This is another important tool furnished in different types and styles, and in many cases capable of being used for a multitude of purposes. A working knowledge regarding its sphere is most desirable. The following list conveys an idea of the number used in one way or another in the building of a firearm: ball or cherry, burnishing, center, chambering, chucking, flat, half-round, hand, pipe, taper, shell, barrel reamers, etc. Each is of a different type according to the purpose it serves. I presume the reader knows that a reamer is a tool used to enlarge a hole that already exists, whether it is a drilled, cored, or taper hole, imparting to it the desired size and finish. In Volume II, Chapter IX, full details on the making of reamers will be given, but a preliminary understanding of their use will not be amiss.

There are one or two points to remember in the proper use of reamers which should be understood by every one, as for instance, providing a proper tap wrench the same as you would for a tap, and not attempting to make the same tap wrench do for all reamers. A small reamer should be used with as much care as a small tap, always with plenty of lard oil; for when a reamer becomes dry it tears out the steel instead of cutting it. In the use of barrel or chambering reamers the best grade of lard oil should be used.

Always watch the cutting edge of a reamer carefully to see that it does not pick up metal. When a reamer starts to do this, take a fine Arkansas stone and stone the top edge to the cutting point and also the face of the flutes, creating a keen edge which, after it is once brought

section lines and are used by the engineer to tell the reader that the part of the view covered by such lines is as if the work had been cut through and a portion removed. Chapter IX, Volume II, furnishes examples of section lines in the various figures it contains. Sections open up the interior of an object or a combination of working parts; as an example, the spindle of a drill press or an electric motor is sectioned to give a clear view of the inside. To use a homely illustration, the engineer seeks the same effect as the fruit peddler does when he cuts a melon in halves for the customer's inspection. A view so drawn is said to be sectional; hence the term "section lines." In the case of the drill-press spindle, some of its parts may be of steel, some of bronze, some of cast-iron. To show which parts are of cast-iron, of steel, or of bronze, the engineer makes use of various arrangements of sectional lines, each arrangement showing a different material.

Shaded Lines — It must be admitted that the average view of a piece of work on a drawing is a rather flat and dead thing. Some imagination on the part of the reader is needed to give it life—to make it rise from the paper and take on form and substance. Fortunately for a machinist who is just learning to read blueprints, much of his work comes to him roughly in the form in which he is to finish it. This is especially true when he is finishing ordinary castings. There are several methods used to give the blueprint more life. One much-used method is to make certain of the working lines of increased thickness to represent a shaded portion. These heavier working lines are known as "shade" lines and aid somewhat in making the view stand, or lift from the paper. Shade lines are used to a lesser extent now than formerly, as the mechanic is supposed today to use his imagination when reading blueprint views.

Line Shading — The term "shade lines" should never be confused with the term "line shading," which refers to a decidedly different use of lines. Line shading as commonly used consists of a series of lines placed on the view within its working lines and arranged in such a manner as to give a picture effect of the view. As in the case of shade lines, line shading is used less in machine-shop drawings than it formerly was.

Finished Lines — Another line used in drawings or blueprint views is sometimes termed a "finish" line. Such a line is usually broken up into dashes and dots and is then known as a "dashed" line. It is placed on the view close to a working line to

indicate that the surface represented by the working line is to be finished. Dashed lines are now little used for this purpose because of the chance of their being confused with dotted lines used to represent hidden surfaces and edges, and other methods of indicating finished surfaces are popular, but eliminated in all the views shown in these two volumes. When dotted lines are shown they represent an inside hole, etc.

Certain conventions, as they are called, are often to be found in a number of drawings throughout the books. Screw threads, as an example, are shown in two ways: full thread, and parallel or vertical lines. They are seldom shown on a drawing as actual threads, but are "indicated" by an arrangement of parallel lines across and vertical to the surface which is to be threaded. A note is usually lettered on or near the threaded surface, giving the number of threads per inch and the form of the thread.

The careful reader of this chapter must now be impressed with the need of knowing things. The way to know a thing is to study it, just as a child studies his book when learning to read. The child first learns the simpler words, how they look, what letters of the alphabet are used in spelling them, and how the words are pronounced; and one who is willing to study this chapter and the drawings the books contain can learn how to read ordinary drawings readily.

It will help if you take a variety of simple drawings, with which you are more or less familiar, and select one for analysis, together with the part in your hand. Carefully study each drawing as well as the text, for in the first place you will become acquainted with good practise carried out by finished engineers, and in the second place you will, by this thorough analysis, train yourself to see in any drawing everything that was intended to be brought out better than words could express it.

Mechanical Drawing — The subject of mechanical drawing is of great interest and importance to all mechanics and engineers. Drawing is a method of showing graphically the minute details of machinery, tools, gauges, dies, etc. It is the language by which the designer speaks to the mechanic; it is the most graphic way of placing ideas and calculations on record. An inspection of any of these accurate, well-executed drawings gives a better idea of a part than a lengthy written or verbal description. The better and more clearly a drawing is made, the more intelligently the mechanic can comprehend the ideas of the designer. Thorough training in this important subject is

necessary to the success of every one engaged in mechanical work.

The draftsman or designer is dependent for his success to a certain extent upon the quality of the instruments and materials which he uses. As a beginner, he can often find a cheap grade of instrument sufficient for his needs, but after he has become an expert, it will be necessary for him to procure those of better construction to enable him to do more accurate work. If possible, it is better to purchase the well-made instruments at the start.

Paper — In selecting drawing paper, the first thing to be considered is the kind of paper most suitable for the proposed designs. For shop drawings, a manilla paper is often used because of its toughness and strength, as these drawings are likely to be subjected to hard usage. When a finished drawing is to be made, the best white drawing paper should be obtained, so that the drawing will not fade or become discolored with age. A good drawing paper should be strong, it should also have uniform thickness and surface, and it should stretch evenly and lie smoothly when stretched. The finer drawings are made on tracing cloth transferred from the pencil drawings and inked in. A linen tracing cloth should also be of the best grade, a grade which should neither repel nor absorb liquids and should allow considerable erasing without spoiling the surface. It is, of course, impossible to find all these qualities in any one paper or linen, as great strength cannot be combined with fine surface. However, a kind should be chosen which combines the greatest number of these qualities for given work.

The usual method of fastening paper or linen to a drawing board is by means of thumb tacks. Fasten the upper left-hand corner and then the lower right, pulling the paper taut. The other two corners are then fastened and a sufficient number of tacks are placed along the edges to make the paper or linen lie smoothly.

Drawing Board — The drawing board is usually made of well seasoned and straight-grained soft pine, the grain running lengthwise to the board. The experience gained in stock making should enable one with the use of wood-working tools to construct one of these very easily, in any desired width or length, together with the two horses to support it. Each end of the board is protected by a side strip, $1\frac{3}{4}$ to 2 inches in width, whose edges are made perfectly straight for accuracy in using the T-square. Frequently the end pieces are fastened by a glued matched joint, nails, or screws. Two cleats on the bottom, extending the whole

width of the board, will reduce the tendency to warp. Drawing boards are made in sizes to accommodate the dimensions of paper in general use.

Pencils — Lead pencils are graded according to their hardness, the degree of which is indicated by the letter H, as HH, 4H, 6H, etc. For general use a lead pencil of 4H or 5H should be used, altho a softer pencil than 4H is better for making letters, figures, and points. The hard lead pencil should be sharpened so that when penciling a drawing the lines may be made very fine and light. The wood is cut away so that about $\frac{1}{4}$ or $\frac{1}{2}$ inch of the lead projects. The lead can then be sharpened to a chisel edge by rubbing against a piece of sandpaper fastened to a wooden block, or even a fine file with the corners slightly rounded. Only a light pressure should be exerted on a hard pencil, as otherwise the chisel edge will make a deep impression in the paper, which cannot be erased.

Erasers — The little erasing necessary should be done with a soft rubber. To avoid erasing the surrounding work a metal eraser shield should be employed. For cleaning drawings when they are completed, a sponge rubber, or a preparation called "Art Gum," may be used, but in either case care should be taken not to make the lines dull by too hard rubbing.

T-Square — The T-square (which gets its name from its general shape) consists of a thin straight-edge, and the "blade" with a short piece called the "head," which is fastened at right angles to it. T-squares are usually made of wood; pear and maple are used in the cheaper grades. The better woods, such as Honduras mahogany, are made with protecting edges of ebony or celluloid. T-squares are sometimes provided with swivel heads, as it is frequently convenient to draw lines parallel to each other which are not at right angles to the left-hand edge of the board.

Triangles — Triangles are made of various substances, such as wood, rubber, celluloid, and steel. Wooden triangles are cheap but very apt to warp out of shape. Celluloid triangles are almost exclusively used on account of their transparency, which enables the designer to see the work already done even tho covered with the triangle. Triangles from six to eight inches on a side will be found convenient for most work. Altho there are many cases where a small triangle measuring about four inches on a side will be found useful, every student should have at least two triangles, one having two angles

of 45 degrees and one right angle; and one having angles of 30, 60, and 90 degrees respectively.

Ink — India ink is always used for drawing, as it makes a permanent black line. It is obtainable in solid stick or liquid form. The liquid form is much more convenient but contains an acid which corrodes steel and makes it necessary to keep the pen perfectly clean.

Protractor — The protractor is an instrument used for laying off and measuring angles, and is made of steel, brass, horn, or celluloid. When made of metal, the central portion is cut out so that the engineer may see the drawing. The outer edge is divided into degrees and tenths of degrees. To lay off the required angle, use a very sharp hard pencil so that the measurements may be accurate. Place the protractor so that the two zero marks are on the given line, produced, if necessary, and the center of the circle is at the point through which the desired line is to be drawn.

Scales — The scales used for obtaining measurements on drawings are made in several forms, the most convenient being the flat with beveled edges, and the triangular. The scale is usually graduated for a distance of 12 inches. The triangular scale has six surfaces for different graduations and the scales are so arranged that the drawings may be made in any proportion to the actual size. For mechanical work the common divisions are multiples of two; therefore drawings are made full size, $\frac{1}{2}$ size, $\frac{1}{4}$, $\frac{1}{8}$, $\frac{1}{16}$, $\frac{1}{64}$, etc. If a drawing is $\frac{1}{4}$ size, 3 inches equal one foot; hence 3 inches are divided into 12 equal parts and each division represents 1 inch. If the smallest division on a scale represents $\frac{1}{16}$ inch, the scale is said to read $\frac{1}{16}$

inch. Scales should never be used as a substitute for the triangle or T-square in drawing lines.

Irregular Curves — One of the conveniences of the designer's outfit is the "French" or "irregular curve," which is used to draw curves other than arcs of circles with either pencil or line pen. This instrument is made of wood, hard rubber, or celluloid, celluloid being the best, and is made in various shapes. Curves drawn with an irregular curve are called free-hand curves. In inking curves, the blades of the pen must be kept tangent to the curve.

No drawing of a mechanical nature is finished unless all headings, titles, and dimensions are lettered in a plain neat type. Many drawings are accurate, well planned, and finely executed, but do not present a good appearance because the designer or draftsman did not think it worth while to letter carefully. Lettering requires time and patience, especially for the beginner, and many think it a good plan to practise lettering before commencing drawing. Poor writing need not necessarily mean poor lettering, for good writers do not always letter well. In making large letters for titles and headings it is often necessary to use drawing instruments and mechanical aids, but small letters, such as those used for dimensions, names of materials, dates, etc., should be made free-hand.

If the reader has fully comprehended the implication of this chapter, a fair degree of drawing knowledge may now be assumed, and he is ready to pass on to more complicated problems. When we turn to subjects in either the first or second volume, however, we find that a knowledge of geometrical figures and their properties is absolutely essential to a clear understanding of the problems chosen in gun making.

CHAPTER VI
Safety With
Firearms

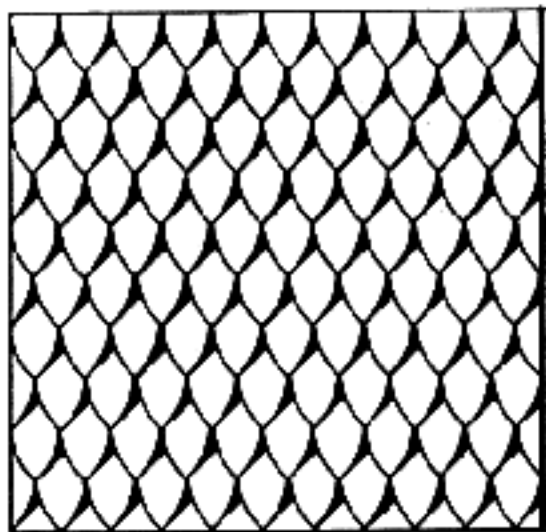

Safety with Firearms

IT MUST be realized, especially by the amateur starting to remodel guns and rifles, that firearms bear a close relationship to the ammunition they were designed for and that few of them can be "stepped up" to the use of later and more powerful loads. If one will consider the tremendous increase in pressures that has been obtained and keep this firmly in mind, it will govern him wisely and safely in his experiments. No one in his right senses would put a steam pressure of 300 pounds upon a boiler designed for 50 pounds, yet men will strangely insist on doing this very thing with firearms. Take for instance the fine old Krag rifle—why was it set aside and a brand-new rifle adopted? Because it was not a clip loader, and was only designed for a maximum chamber pressure of 42,000 pounds, while the advance in ballistics provided a new cartridge, and the .30 caliber model, 1906, required a rifle capable of withstanding *five tons* more pressure than was provided for in the Krag. Not only was a much superior grade of steel needed, but a new and different breech action, stronger in every way, was imperative. Now because these pressures are maximums, it is possible to overload a rifle and get away with it at times, but remember you are flirting with death or disablement when you attempt it; and if you deem this price too high, be ultra careful with pressures and always err on the safe side. Figure 47 will

show what happens when one makes a careless mistake.

Because of the limitations of weight, few guns carry more metal than necessary, but this is of the best quality and is scientifically heat-treated to secure the utmost of its inherent strength and stability. Remember, if you disturb this "temper" in your experimenting or changing, and do not know how to restore it surely and absolutely, you have weakened your gun to a dangerous point and rendered it unfit for the pressures it was made to withstand. The same thing applies to the removal of metal at vulnerable points. To insure your safety as well as the other fellow's, let us here consider a few rules that must never be broken.

1. *Do not* draw the temper of receivers and breech actions unless you know how to restore it scientifically and surely.
2. *Do not* attempt to weld or even braze appliances to any part of an action or receiver.
3. *Do not* remove metal from any point of an action which is involved in the stresses of explosion.
4. *Never* permit a cartridge in a gun in which the locking mechanism is faulty.
5. *Be cautious* in the remodeling of a gun to the use of a more powerful load than it was originally designed for.

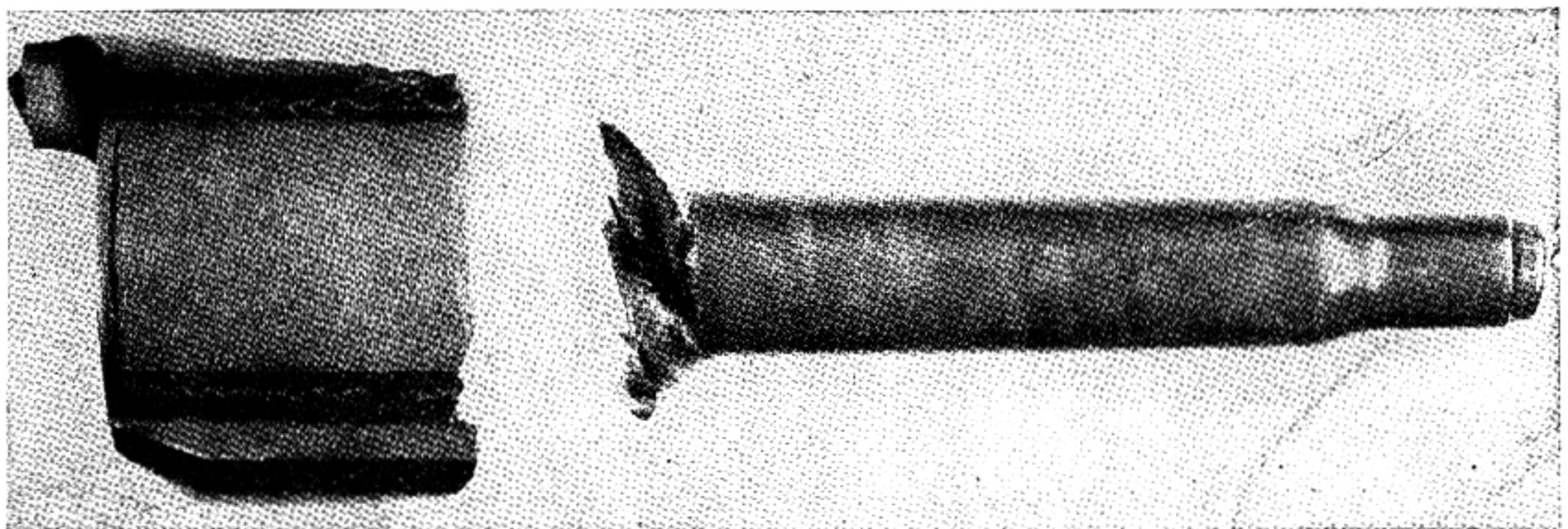

Fig. 47

A Springfield rifle that blew up because of carelessness. Heavy grease in chamber and barrel, plus excess head-space and a soft cartridge case—a perfect combination to cause such accidents

6. Remember that in ninety-nine cases out of one hundred the higher pressures, velocities, and power attainable in a rifle are not required for any work you will call upon that rifle to do.
7. Remember that in a shotgun, unlike a rifle, higher pressures add very little to range or power.
8. *Do not* spend a moment on a firearm which is to be actually used, that is not substantial, correctly designed and made, and capable of being restored to its needed strength and utility.
9. Remember that the dividing line between black and smokeless powders and lead and encased bullets is a deadline, and marks an abrupt transition in the design and make of firearms. *Never* compromise this deadline.
10. *Never* say "good enough" in firearms. If you can't say "right," put the job in the antique cabinet, or, if broken, in the junk pile.
11. Eschew makeshifts. You have seen hundreds of them just as we have. All our marvel has been that they worked. We never expected they would, and some time they *won't*. Take the makeshift firing pin; did you ever stop to think what would happen if this makeshift *pierced* a primer?
12. Watch trigger pulls. The trigger is the spark that fires the mine. Learn and teach how to press a trigger that offers safe resistance rather than reduce a pull to a point that endangers safety.
13. Remember in conditioning old muzzle-loading rifles for use that you cannot get advanced power or accuracy out of these old guns by modern propellants or heavier charges. Stick to and advise a rigid adherence to the old black powder and the bullet that belongs with such rifles.
14. It may seem strange, but people often leave charges in guns; therefore, habitually make sure a gun is *empty* the moment it touches your hands. If it is loaded, always unload it, never shoot the load out.

Modern developments have made firearms as safe as any other mechanical device that we utilize today. The automobile, for instance, is in itself a fairly safe means of transportation, yet it has taken toll of countless lives, and statistics will show that the greater percentage of these have been caused through sheer carelessness.

There are many cheap and obsolete shotguns in circulation that should be discarded or thrown in the scrap pile. Many of the old guns have been handed down from generation to generation. Naturally, there is a certain sentiment attached to them and their preservation is admirable. However, we

should be able to discern between sentiment and danger. It is a pity, in this respect, that we do not feel as the Chinese do toward their ancestors; for then it would be sacrilege to use their personal possessions. It would at least prevent a number of accidents that are incurred from using antique arms.

One day a man came into the shop with an obsolete double-barreled hammer gun on which he wanted the forearm replaced. Naturally the cost of the replacement was prohibitive, for he could purchase a modern gun for less than the price of a new forearm. Upon examination of the gun, I found that when it locked, the barrels could be raised from the action $\frac{1}{16}$ inch. There was also an opening of $\frac{1}{32}$ inch between the barrels and action. I advised him to discard the gun and to purchase a new one for his own safety. My warning only caused him to become very indignant and he informed me, not very politely, that he had used it in its present condition for two seasons, and expected to use it several more seasons, as he simply held the barrels and action together while firing! I will let the reader draw his own conclusions as I have mine.

Every now and then some misguided person replaces a broken firing pin with a common wire nail, instead of sending the arm to a gunsmith for repairs, or to a machine-shop where they have the proper tools to pattern one after that which has been broken. I can name any number of such cases of gross neglect, where a person could not foresee the results of a sharp-pointed nail piercing a primer, causing the gases to rush out at the time of ignition, and force the nail back into the shooter's face. If one should happen to see another using such a combination, the law of safety should be explained in language that a church member would not care to hear.

When changes are made, such as using one of the old single-shot actions for modern high-velocity ammunition, be very careful to see that all parts fit well, particularly the block where the firing pin is located. For instance, in fitting a new barrel for the .22 Hornet cartridge, or even using the old Winchester single-shot action that originally came for the .22 Winchester center-fire cartridge, since this is a lead bullet and a low-velocity cartridge, the firing pin or firing-pin hole is over $\frac{1}{8}$ inch in diameter in the block. It is then our first consideration to turn the firing pin and bush the hole so that it measures from $\frac{5}{64}$ inch to $\frac{3}{32}$ inch in diameter. Our better judgment will tell us, after measuring the primer, that between the primer and firing pin there is only a little over $\frac{1}{32}$ inch left on a side to hold the primer in place. This may be enough to hold the primer, but if the firing pin is soft, and it

develops a point that will pierce the primer, there is enough pressure developed to send the escaping gases back into the shooter's face, causing a painful injury and possible loss of eyesight. By all means, figure out the area of the primer and the firing-pin hole and let the results prove to you that there is present enough metal to hold back any gas that should escape from a pierced primer.

The deeply interested person will study the development of powder from the early Middle Ages up to the present improved military powders used in high-velocity ammunition. All the large powder companies distribute tables of the correct powder charges to use in certain cartridges and the weight of bullets. Still, some disregard these tables and add just a little more to obtain a higher velocity than the other fellow.

I recall that when I was at the Arsenal, tests were made with the armor-piercing bullets against armor tank plates, and the different light plates were carbonized to certain degrees of hardness. These tests were conducted on the artillery range. The plates were placed in a frame and the Model 1903 Springfield rifle in a machine rest. The regular armor-piercing ammunitions would not penetrate some of the heavy carbonized plates, so ammunition was loaded with the standard improved military powders, such as Du Pont No. 15, 15½, 16, 17½ Pyro, or No. 20, and also the later improved powders under other numbers. The recommended loads were increased by one grain at a time, in order to have the projectiles go through the heavy plates. With Du Pont No. 16, one of the fast-burning powders, a load of sixty-one grains was reached which blew up the rifle. The action held, but the case blew out the rear, allowing the gases to escape into the magazine, opening the magazine on the sides, and splitting the stock from the front sling swivel back three or four inches from the comb, completely shattering the wood. The same thing is likely to happen if only one or two more grains than the given charge are added.

I have had much of this brought to my attention. Men have brought in cartridge cases, after firing, showing the bad primer bulges, and even the primer flowing back into the firing-pin hole. Naturally, they condemn the cartridge cases, but upon questioning them I find that they increased their powder charges one or two grains. Talking seems to be of little value; it is only through bitter experience that they will ever learn or accept the truth.

At the present, there seems to be quite a fad for using old muzzle-loading rifles, and they are loaded with every kind of charge, from the military powders to the black powders. These old guns are only made of common wrought iron, a grade about ten

degrees lower than the common machinery or cold-drawn steel used today, and even an overcharge of black powder is more than they can stand. One was brought to my attention on which the nipple plug was blown out and just escaped hitting a person standing at the side of the shooter. I learned that E. C., a quick-burning shotgun powder, had been used, as it was much cleaner than the black powder which left too much residue in the barrel.

As we know, excess grease or oil in a barrel or chamber will cause the first shot to be high. It not only runs the pressure above the allowable pressure recommended, but may cause excess head space between the bolt and cartridge cases. Very often you will find a soft case among the ammunition you are using. A soft case is one which was lodged in the drums of the annealing furnaces and probably stayed in the worm for half a day. The furnaces are of the rotary type with spiral drums feeding the cases in one end, and by the time they reach the opposite end they have the proper annealing for the following draw. This seldom happens, for such conditions are watched very closely, and when a furnace shows the least defect, it is remedied. Still, there may be such a condition existing, so it is best to use every precaution. Check your rifle for head space and make sure that all oil or grease is cleaned out before firing.

Such a small obstruction as a cleaning patch placed in the muzzle of a rifle to protect the interior from moisture, and negligently left there, will split the barrel from muzzle to chamber. When a bullet hits an obstruction of this nature, it may be compared to a swiftly moving box car that hits another which is at rest, except that there is a propelling force of gas behind the bullet, and this sudden stoppage of the projectile hitting the obstruction sends the gases around the bullet, thereby opening the steel to allow its passage. Even the .22 caliber short rifle cartridge will ring or bulge a barrel when it comes into contact with the lodged bullet. If these small bullets can do this, you can imagine what a high-velocity cartridge would do.

The first thought that occurs to one, when a bullet or part of a cleaning rod is lodged in a barrel, is to shoot it out by removing the bullet from a case and inserting the case by holding the rifle in a vertical position so that the powder will not scatter around in the working parts of the action. It is possible in this manner to remove an obstruction when it is only lodged a short distance in the barrel from the chamber end. The instance of bursting a great distance from the chamber is due to the air space that is compressed with the gases which are greater in velocity than the movement of the obstruction; the whole expanding force of the gases and air concen-

tration at that point expands the barrel. If it is not possible to take the gun to a gunsmith, it will be best to remove the bullet, together with half the powder charge, and try to shoot the obstruction out, rather than spoil a long anticipated hunting trip. This, however, does not apply to a shotgun, for you will most certainly have a burst barrel and a ruined arm.

Many pistols and revolvers are also ruined in this manner. A .45 Colt automatic was brought to my attention which had exploded in the shooter's hand. The bullet was lodged half-way in the barrel, so he tried to shoot it out. The barrel opened at the bottom, split the underside of the frame, and folded it back to the trigger guard. It also blew the spring and guide free from the action. At times, it will only bulge a barrel (of course practically ruining the arm), but usually it means a completely ruined revolver or pistol.

Very often, there is improper head space between cartridge head and bolt or breech block. This condition will manifest itself by the parting of the cartridge case about one-half inch from the head. At first a rupture will appear, which is the first indication of excess head space in a chamber. Upon examination you will find, when the bolt is in the firing position, that too much space exists between the head of the cartridge and the face of the bolt; you can detect this condition by inserting shims of brass or copper. A good many Mausers have this defect, particularly the actions which were sent over after the war and made into sporting arms; also the large magnum actions that came over in the white and were never heat-treated before being made into rifles of the .375 and .275 calibers. The Springfield rifles or any other rifles using high-velocity ammunition turned out by the private arms companies have the correct head space, as they use gauges to determine this chambering to the minimum length; and since they have a rigid inspection in such factories, there is never any danger of this defect. When there is only 0.004 inch tolerance, it necessitates picking out a number of cases in order to come to some conclusion as to the proper head space.

The most prominent defect of the Model 95 Winchester rifle using the Model 06 ammunition,

was that the frame of this arm spread until the cartridges parted in the chamber; as a result it was necessary for the Winchester Repeating Arms Company to discontinue this model. There are still a number of them in the hands of American sportsmen, but sooner or later they open up to such an extent that they are discarded.

When a barrel wears out on a high-velocity rifle, many persons with limited means will look around for bargains, and of course, nine times out of ten, they never get a barrel to fit the action they have. Following the various suggestions of their friends, they either sweat or shrink a collar on the chamber end and then thread the barrel to fit the action. If you will conduct a little experiment of your own, it will demonstrate better than any description, just what results will follow from doing this. Take a test piece of the same size, with the same hole in the center. Sweat or shrink a collar to this piece and then take it to a place where they have a good hydraulic press and you will be surprised to learn what little force it requires to tear them apart. In a high-velocity arm there is a pressure of 50,000 pounds developed; by adding 50% for a margin of safety you will note that such an operation falls short of these figures. Do not think that the amateur alone is responsible for these ideas. Far from it, for generally they originate from others that are in a position to know better. The first .50-caliber gun which came to the Arsenal from the Springfield Armory had just such a collar shrunken to the end of a .50-caliber barrel, and upon the first shot for velocity, the barrel was stripped from the collar and landed seventy feet down the range. They had made doubly certain of the shrinking operation by placing taper pins on each side. These were sheared off as clean as tho cut by a chisel. Picture what damage would occur to the shooter's hand by a barrel breaking loose from a receiver in the act of firing.

The man capable of becoming proficient in the handling of firearms will require no special rules for his government in this matter. Rules are for the careless individual, and yet one could give such a person a book full of them and he would then find something that no one else has ever discovered.

CHAPTER VII
Selection of
Woods

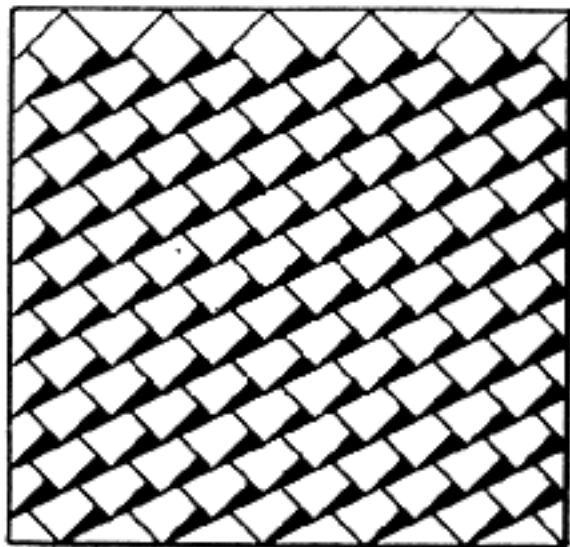

Selection of Woods

THE conditions governing the selection of wood for gunstocking are so exacting that one's choice in the matter is practically determined in advance. The wood *par excellence* is walnut, and there is no substitute. Walnut seems to be purposely designed for gun stocks. No other wood or material possesses all the qualities that are demanded by the gunsmith, and nothing better could be desired. The growing scarcity of this wood, especially the European varieties, which have been drawn upon for centuries, has caused intensive search to be made for substitutes, and the forests of the whole earth have paraded their finest growths only to have it more firmly demonstrated that walnut is king of them all.

The chief qualifications in the wood to be used for stocking are as follows: It must be tough and very strong, for gunstocks are much cut up by the mechanisms and yet have to endure not only the shocks and stresses of explosion, but the hard uses that are inseparable from hunting and the battlefield. It must be homogeneous and fine in its grain so that it may be worked down to an exact fit without splintering. This is particularly apparent when one is inletting the locks of a side-lock gun. It must be a wood that, when thoroughly seasoned, will "stay put" and not be subject to further warping, shrinking, and twisting. It must be a wood which withstands the rotting effect of lubricating oil, for lubricants and rust preventives are indispensable and continuous. It must be, in spite of its strength, of moderate weight, for balance is one of the prime requirements in a gun and this cannot be secured in wood that is too light or too heavy. Last but not least, it must have beautiful grain if it is to please the eye and satisfy perfectly. Strange and wonderful as it may seem, walnut, at its best, is supreme in every one of these qualities, and furnishes the greatest ornament you can place on a gun—its own natural, inimitable beauty.

There are a number of species of the walnut tree, several of which are indigenous to America. That species, however, which yields the nuts which we call English walnuts, is by far the best. Its botanical name is *Juglans Regia*, and it is native to all the Central and Southern European countries and that portion of Asia which we designate as

Asia Minor. It was brought to America by the early colonists, and, while not hardy generally north of Washington, D. C., there are still numbers of these trees scattered through the Northern States. Undoubtedly, hardy varieties of *Juglans Regia* can and will be developed that will thrive wherever the apple and peach can be grown. Within the last few decades this so-called English walnut has been extensively planted in California and all our nuts and eventually our gun stocks will be home-grown.

Actual English walnut, that is, walnut grown in England, is practically non-existent so far as the gunsmith is concerned. There is indeed a limited supply, and it is good, possessing all the best characteristics of the wood, except the very finest figure; but the bulk of the best English walnut comes from Southern France and Northern Italy, together with other supplies from Eastern Europe and Southwestern Asia. That known as "Circassian" is from the last-named countries and is a very beautiful wood, showing perhaps the most splendid markings of all. However, it is not generally cut and handled so well as that grown and cut by expert foresters in Europe, and for this reason it is hard to get blanks free from preventable defects.

Our American black walnut, botanically *Juglans Nigra*, is a most useful variety and furnishes the stocks for practically all our commercial sporting and military firearms. With the one exception of *Juglans Regia*, it is the best stock wood extant. It is not generally as well figured as the European variety, but the most beautiful stocks are frequently obtained by grubbing out that portion of the tree where the roots and trunk join. These are the source of the "fancy" stocks furnished by our leading gunmakers. Black walnut is a dependable wood and fortunately relatively cheap (it would be a calamity not to have a constant supply available for all time), but it is not—for we must not assume that all of the great Creator's masterpieces are confined to our country—nearly as good a stock wood as its European congener. I am quite sure of myself when I say that you, Mr. Amateur, will do a much better job in much less time if you use the more compact, yet more easily worked,

European walnut. When machinery does all the cutting and profiling, the case is not quite the same, as a lightning-speed spiral cutter does things in inferior woods that hand tools only accomplish laboriously and slowly.

The seasoning of wood is well understood professionally, and great advances have been made, especially in our own land, in artificial drying. For most purposes this quick method serves well, but where all the latent strength of the timber is to be preserved it is not nearly as good as the slow and more expensive natural seasoning. Time and fresh circulating air always do the best job.

One of the chief causes of the high price of imported blanks is this expense of seasoning. It means, in the first place, a dead investment for several years, necessitating suitable storage facilities, constant inspection, and frequent handling. The walnut forester has learned how to cut stock blanks to the best advantage and he simplifies his transportation and saves freight or wastage by doing this on the ground. These blanks are sold to visiting buyers largely from Liverpool, England, who grade them and store them for partial seasoning ready for later distribution to the trade. There is quite an art in this preliminary seasoning, and it is remarkable how clearly the expert distinguishes the hidden beauty in an ordinary-looking blank. Moreover, the preliminary seasoning calls for definite knowledge, for this is the really critical stage. Excessive dryness of atmosphere would be fatal. At times artificial humidity must be provided. The ends of the blanks must be coated with some sealing material such as paraffin, paint, or specially mixed creosote to prevent too rapid shrinkage, and the butt ends kept from the light.

The gunmaker, having bought his supplies from the dealer, now continues the seasoning to the point

of completion. This is practically only a question of time, and so each batch is dated and set aside for a period well in the future. As the time of use draws nigh the blanks are weighed at intervals, and not until they have become static are they deemed thoroughly seasoned and ready for use. All this has doubled and trebled the original value of the wood, so we see very plainly why perfect stocks cost so much money. This is particularly noticeable in one-piece stocks where so much more attention has to be given to the direction of the grain and the continuity of the figure. This accounts for the apparent discrepancy between the price of rifle and shotgun stocks. It is very easy to obtain, in the smaller piece required for a shotgun butt, the choicest figure; but when you double the length and ask for ten times the strength your demands are far greater. Figure 48 illustrates shotgun butt stocks.

A great many of you, I fear, will for various reasons be compelled to get your stocking wood locally and of local material. By all means get walnut if procurable. If you expect to make a number of stocks, buy a supply that you can cut up and lay aside for complete seasoning. Don't get your plank too thin. To get straightness and cast-off in the right direction you will require a 2½ inch raw plank. Do not cut the piece into blanks until it is air-dry. It should be at least a year-old plank. Store your blanks inside—a loft over an outbuilding is good, and it is well to start a rack overhead in your workshop to finish their drying.

There are many features that contribute to the great difference in the quality of walnut. Rich soil hardly ever produces beautiful figure; the tree has grown too swiftly for that. Figure, like virtue, seems to be the product of struggle, of adversity.



Fig. 48

Shotgun stock blanks, furnished by Mitchell Bosley of Birmingham, England. Circassian and French walnut

Climate also has its effect. The walnut tree in the Middle States is the largest and cuts up into the best merchantable lumber. Rarely, however, does this have the closeness of grain and the firmness of texture that is found in the lumber of the hotter and dryer Southwest. Walnut grown in high, well drained soil is invariably better than that grown in swampy ground or river bottoms.

So, as far as you can, be very "persnickative" in your wood, getting the best procurable, and however strong the temptation, do not use a piece, ever, until it is as dry as the proverbial bone. Good stocking is the acme of all our wood working. You will get more real satisfaction out of this phase of gunsmithing than anything else, if you do it splendidly; so start without handicap.

In choosing a particular blank for a specific arm, you will have to keep balance uppermost in your mind. A heavy gun forward will require weight at the butt, and you will need a dense stock; while on the other hand, a light, lively weapon, such as a small-bore shotgun, will need a light butt-stock. Weight of stocks cannot, how-

ever, be entirely controlled by the wood itself, and it is quite permissible to reduce butt-weight by boring cavities under the butt-plate. This in no way weakens the stock. By artificial weighting in the same place, balance can often be improved.

Be very careful, in selecting your stock blank, to see that it is free from shakes and checks. The former are caused either by wind strains in the growing tree or by carelessness in felling the tree; checks, on the other hand, are the result of too rapid drying. Both defects have an unpleasant habit of getting worse rather than better as you work your stock down, owing to the fact that you are relieving them from the support of the surrounding wood; so be careful to ascertain the depth of these defects before placing a lot of work on your stock.

There are a number of British firms who supply stock blanks and who will send by parcel post to your door just what you order. The price charged is based entirely on the quality, and you will be treated with absolute fairness. There is no duty on these blanks. Our outdoor journals also carry



Fig. 49

Rifle stock blanks, furnished by Mitchell Bosley, of Birmingham, England

advertisements of several American purveyors of seasoned blanks of American wood. I have found these equally reliable. Figure 49 illustrates rifle blanks.

There are a number of our native woods which have been used at various times for gun stocking. The early American gunsmiths were partial to hard maple, especially when they could obtain those beautiful freaks of nature which we call "curly maple" and "bird's-eye maple." There was good reason for this. Maple has many valuable characteristics; it is strong, close-grained, and in its own particular way, handsome. With a profusion of brass trimmings it toned quite well. It does not harmonize nearly as well, however, with the blue of our modern steels and colorful case-hardening. Its light color makes it a bit too conspicuous in the woods, and in my opinion it gives up most of its beauty when stained to a darker color. It does not tone down attractively by age, and it is particularly susceptible to the rotting effects of lubricants, soon becoming "dotey" when impregnated.

The selection of a wood depends upon the personal taste of an individual. Some like the American black walnut, others the foreign walnut, and still others admire such woods as cherry, apple, mahogany, maple, etc. A list of all the woods, not only for gun stocks, but inlays and cabinet work, etc., may help the reader to make better selections. Some of the woods can be used for experimental purposes.

The weights given in this chapter on woods are the weights per cubic foot in pounds. The ideal weight of wood for a gun stock is between 37 and 48 pounds per cubic foot. All substances are judged by this method, and the gunsmith must also judge his stock blank by this rule. All figures are taken in the dry state.

Almond Wood — Weight 42 pounds. Cuba. In texture, weight, and general character it reminds one of Cuban mahogany, but differs greatly from

this in its color, which is grayish-brown and is marked with bluish streaks. All blanks display a more or less wavy and curly grain, with those forms of rich figure that are commonly designated as "roe" and "splash mottle." A very fine wood when one wishes something a little different in a presentation stock.

Amboyan — Weight 39 pounds. Borneo. The name *Amboyan* or *Kiabora* wood is applied to certain burrs imported from the Moluccas (including Amboyan) and Borneo. The wood is brown, tinged with yellow or red, but changes with age to a dull brown-leather color. It is marked with little twisted curls and knots in a manner similar to, but more varied than, bird's-eye maple. With the naked eye it is difficult to distinguish between the burrs of Amboyan wood and *Thuya*, or even yew; but tho the burr wood of the yew is similar to that of the other two as regards color, it is, nevertheless, unlike them in all other respects. Amboyan wood has been freely utilized in the manufacture of ornamental or costly furniture and for the interior decorations in motor cars. This wood is very fine for decoration on firearms such as forearm tips, pistol-grip caps, and inlays. It is rather expensive in large pieces.

Beef Wood — Weight 59 pounds. British and Dutch Guiana. The wood from British Surinam is the best quality. It is a dull plum-red color and in this respect somewhat resembles raw beef. It is a very durable wood and stands exposure. It is one of the best woods for cleaning-rods, handles, and other useful articles, because when it is turned thin it is still very strong.

Apple — United States. This has its individual qualifications. It is a very close-grained wood and most homogeneous. It inlets beautifully because of its matted fiber. It works well and is a strong wood, but has no natural beauty, being neutral in

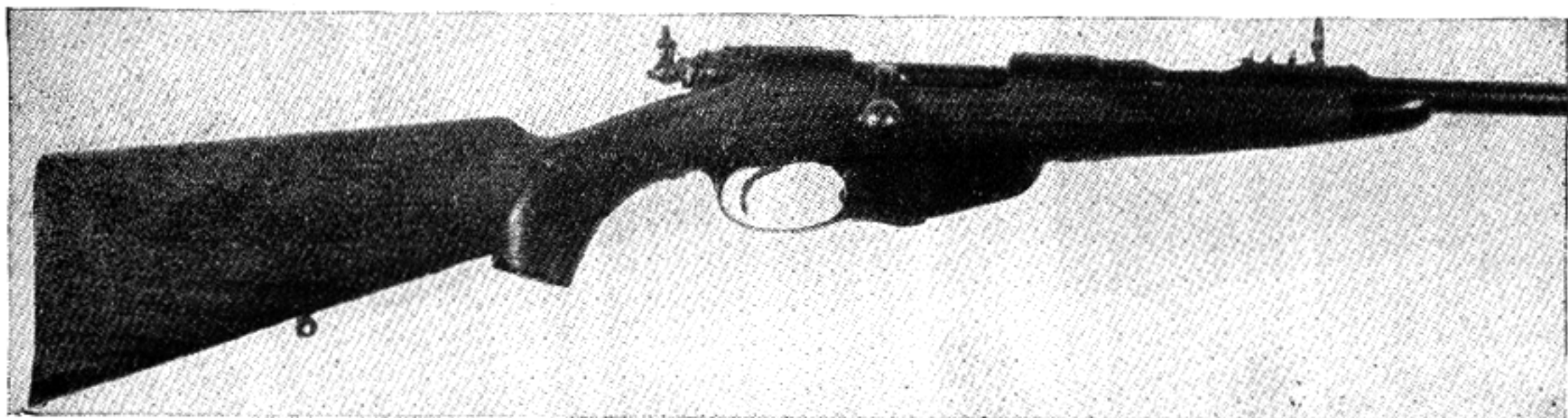

Fig. 50

Caliber 6.5 mm. Steyr action. Twenty-six-inch barrel made by Rigby. Stock of plain French walnut

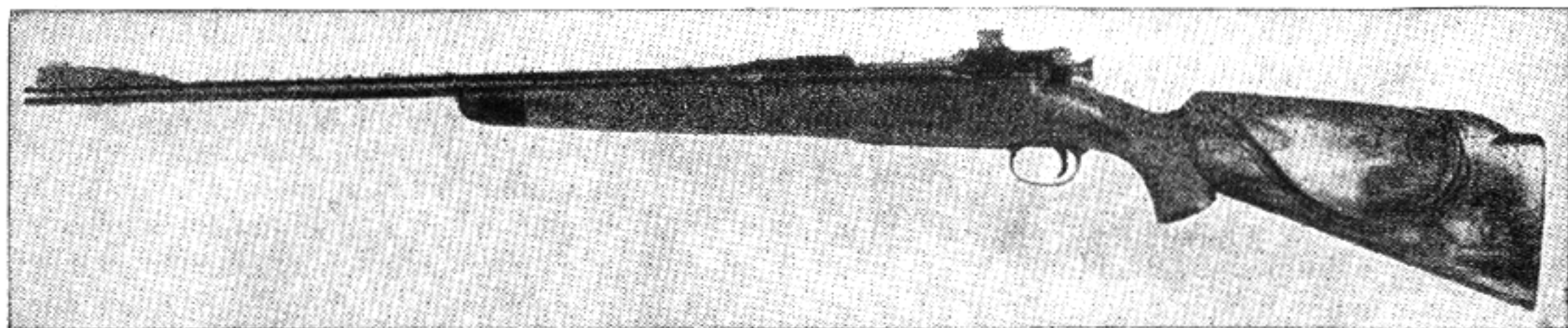

Fig. 51

Light caliber 30-06 Springfield designed by Dr. George Quay. Weight, 6 pounds 14 ounces. Stock of Circassian walnut with much character. Small knot-holes were filled with ivory

color and devoid of ornamental grain or figure. It is not on the general market and consequently is hard to come by.

Bedd — Weight 46 to 58 pounds. India. The heart wood is very dark red, very hard and close-grained, beautifully mottled with light and dark, i.e., black and orange streaks. It seasons well, works and polishes admirably, and is distinctly one of the finest and most beautiful woods in India. This wood can be used for a stock on a rifle or shotgun when one wishes something just a little different.

Benteak — Weight 53 pounds. West coast of India. This wood is a warm brown color similar to that of black walnut, and has a smooth close texture and straight grain. It is highly suitable for decorative furniture and gun stocks, and could be used where black walnut is required. This wood will take checkering very readily.

Blackbean — Weight 40 pounds. New South Wales, Queensland. The merits of this timber are well known in Australia, and some of it is sent over here and sold as myrtle for gun stocks. Blackbean or *Castenosper Mum Australe* has an attractive appearance showing various shades of brown traversed with black streaks, and is often beautifully mottled so that it resembles slightly bleached East Indian walnut. A gun stock of this wood is rather beautiful. It works well with edge tools.

Blackwood, African — Weight 89 pounds. Tropical Africa. This is a dark purple plum-colored wood, now imported from Mozambique and the east coast of Africa, known for this reason as Mozambique ebony. It is mostly suited for turning, as it is very hard, close, and free from pores, but not destructive to the tools. When they are in proper condition the wood receives a brilliant polish. It is considered free from any matter that will cause rust. On this account it is used for the handles of surgeons' instruments. It is used

also for fine inlay work on firearms, forearm tips, pistol-grip caps, handles for fine tools, and grips for side-arms.

The blackwood of Australia is just half the weight of the African blackwood, and in color it varies from a rich reddish brown to nearly black, banded with golden brown; sometimes it is brown and red with dark streaks, and may show a metallic luster. Its grain is close and often curly, and it appears to be somewhat cross-grained, so that the wood often shows a beautiful figure and mottle. This class of wood is used more for fine cabinet work when one wishes a dark wood in an exceptionally fine product. This is one of the strongest woods, and can be successfully used in many ways when strength is required.

Beech — United States. This has probably been the commonest substitute for walnut in gun work by backwoods gunmakers. It was a very usual wood in the old military muskets of muzzle-loading days. It is a serviceable wood for its strong qualities. It is of proper weight, and has an interlaced fine grain that permits close work without danger of splitting. It is neutral in color and devoid of natural beauty. It is purely utilitarian and is never used when better woods are available.

Birch — United States. This, like cherry, has many fine characteristics. It is a strong, firm wood, pleasant to work with and amenable to a good finish. It is generally available in seasoned stock; sometimes a freak plank displays good markings, but this is unusual. It has no natural beauty, but can be stained to the color of walnut or mahogany very readily and successfully. Staining, however, requires a varnish finish, and this is not to be recommended.

Cherry — Weight from 33 to 45 pounds. United States, Europe, Asia Minor. This wood when first cut is light red or pink, has a close firm texture, and is capable of a very high surface polish. It is mostly used for chair making and for the backs of

brushes when stained with lime, oiled, and varnished. It is also used for common and even the best furniture. The wood of the blackheart cherry tree is considered the best grade. This wood was used by the early American gunmakers. There seemed to be a fad existing between 1830 and 1860 for cherry stocks on the muzzle-loading rifles of those dates, when these rifles were made by the backwoodsmen themselves. Cherry is a much easier wood to work than curly maple. I have seen a number of such stocks on these antique arms and could not help but admire their beauty, as the workmen had finished the wood by various methods. Today, with our advanced knowledge of woods, we would not care to stock a rifle with a cherry blank.

Wild Cherry—Weight 41 pounds. United States. This too had its admirers, and when it was plentiful, which it was until thirty or forty years ago, there were opportunities to select pieces of good

Curly Ash — Weighs 38 pounds. United States. This is a most beautiful wood when you can find one of the logs which exhibit this unusual but marvelous figure. Ash varies greatly in its weight and denseness. It is a strong wood for its weight, and this is why it is in universal use for implement handles. It is usually coarse and straight grained, two characteristics which make it unfit for a good stock wood. It is also light in color and so is generally unpopular in gun work.

Ebony, African — Weight 78 pounds. West Coast of Africa. This wood is sent over in billets and short logs with the centers left in. The billets are from about 5 to 10 inches wide and from 2 to 7 inches thick, the logs from 2 to 13 inches in diameter. Gaboon is a good black ebony of fine grain. Ebony is a handy wood to have around the gun shop, for it is possible to do so many inlay jobs with this black wood, particularly when used with ivory to offset the wood. You can not make

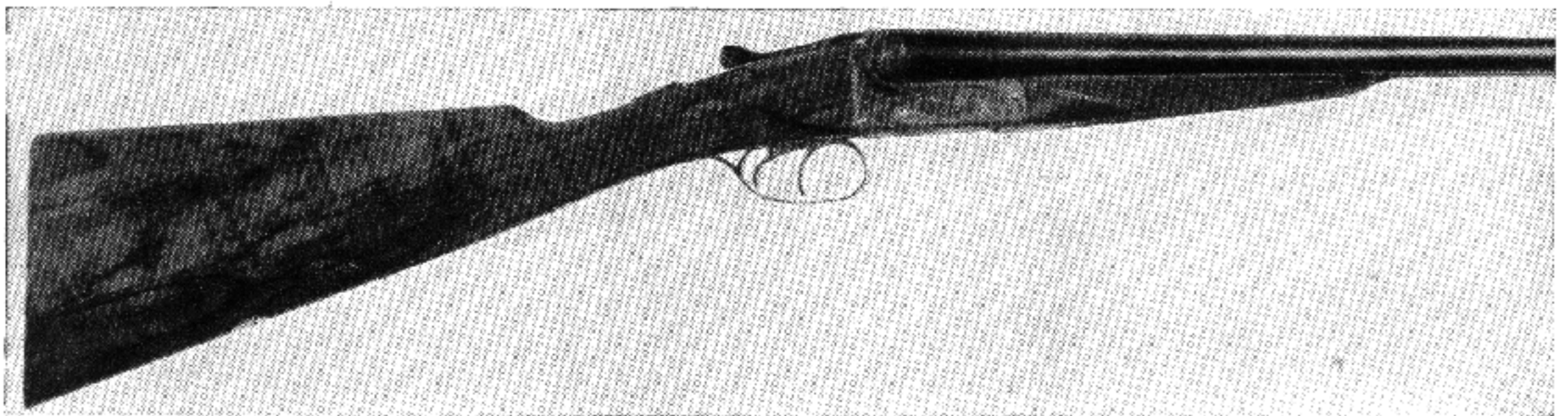

Fig. 52

William Ford 20-gauge double. Restocked with beautiful piece of French walnut of unusual figure and color, and perfect markings on both sides

color and texture which made rather good stocks. Wild cherry is a hard firm wood with little grain, and it is a delightful wood to work with, as it cuts clean and takes a good polish. It also, when dry, is very stable. It is not a strong wood, usually has very little figure, is often marred by "gum pockets," and nowadays is scarce in most markets.

Cocobolo — Weight 85 pounds. Tropical South and Central America. The striped heart-wood shows alternately bright orange and deep red bands, the latter being often streaked with dark or even black veins. Its rich, handsome appearance sometimes has the effect, both as to color and markings, of tortoise-shell. It is hard and heavy and yields a fine finish. When well polished this is a bright wood and is used for such parts as forearm tips, inlays, pistol grips for revolvers, also handles for fine tools.

a more beautiful pistol grip of any other wood when you inlet elongated pieces of ivory about $\frac{1}{8}$ inch wide through the center of a cap, for it stands out so distinctly with an ivory center.

Holly — Weight 47 pounds. Europe. This wood is white to gray in shade, is exceedingly close-grained in texture, and capable of a very light surface polish. Holly is chiefly valued for inlay work and is the whitest and most costly of woods. When fine walnut is inlaid into holly it gives a fine contrasting effect.

Mahogany — Africa, Cuba, Central America, Honduras, West Indies. This wood might suggest itself to many of you, owing to its universal appeal in the best cabinet work. It is easily the king of cabinet woods. It has, in some varieties, the utmost beauty in grain and color, ranging from

light cherry to reddish brown, and is reliable, for when seasoned it "stays put." Mahogany is really a generic name, for it is the product of a number of trees, botanically quite distinct. The mahogany of commerce ranges all the way from the soft, plain "buy wood" of Honduras to the hard, beautiful San Domingo type which is now almost unattainable. The African varieties are also splendid cabinet woods, often with fine figure, but do not possess the lovely color of the West Indian varieties. It would be folly to say that there were not odd specimens of mahogany that would meet the gunmaker's requirements admirably, but this would only be the exception that would prove the rule that mahogany is not a suitable material for stocks.

Maple — Weight 38 pounds. United States and Canada. The best is always asked for and sometimes obtained. It is termed in specifications "hard, white, rock maple." A considerable quantity is found with a curly, twisted grain, and is known as "curly" or "bird's-eye maple." This variety is much in demand for veneers and decorative work. A particular variety of a wavy, curly grain without bird's-eye markings has also been

can Stink-wood — Nearly all the wood imported into the United States and sold as myrtle is the Australian blackbean. This species of wood is very easy to work with edge tools, takes a beautiful polish, and checkers well. The grain runs very close and is of a fine texture. These woods have come nearer than all other tropical woods to the standard set by walnut. But for various different reasons they must stand aside and bow to his majesty, "Royal Walnut."

Osage Orange — Weight 48 pounds. North America. The wood is a bright shade of orange, deepening with exposure to air and light. It is rather lustrous and very pliable and elastic. The fruit is green, orange-shaped and large, with a very warty appearance, and late in the fall of the year the fruit still hangs to the tree. It would be well for one living in a district where these trees grow to cut and cure one, for it is useful in the construction of bows to take the place of yew; in fact, it is known as *bois d'arc* (bow wood). It is also for ramrods for muzzle-loading rifles.

Oak — Weight 52 pounds. United States. This grand timber has great qualities, but none of them



Fig. 53
Savage caliber 25-3000 bolt action rifle, restocked with bird's-eye maple

called "papapses wood," and this is in demand for gun stocks at the present time. The early American rifle makers and gunsmiths used this wavy, curly grain on their best stocks from the flintlock to the percussion period. In those days maple seemed to be the wood mostly used even for the finest furniture. I have made up rifle stocks from this class of wood, but do not encourage a prospective customer to use it, as it is so much harder to work than the walnuts. I must admit tho that there seems to be something in our blood that makes us admire this wood, for when a rifle stock is made from a fine curly piece of maple, it stands out and apart from all other woods.

Myrtle, Queensland Honeysuckle, and Afri-

such as would recommend it for gun work. Of all the oaks, the wood of the live or evergreen oak of the Southern States doubtless lends itself best to gun work, as it is very tough and closer grained than the deciduous varieties. Oak, however, is a wood for large surfaces, and "big" uses. It is not, in nature's scheme, a wood for little things, but it is chief of our native woods that might, in a pinch, be used as gun stocks. None, however, are in all ways as good, and few in any way as good, as walnut.

Paduka — Weight 53 to 59 pounds. Burma. This wood is the product of the true forest paduka tree. The wood varies in color from a bright yellowish red to a dark brick-red and is sometimes

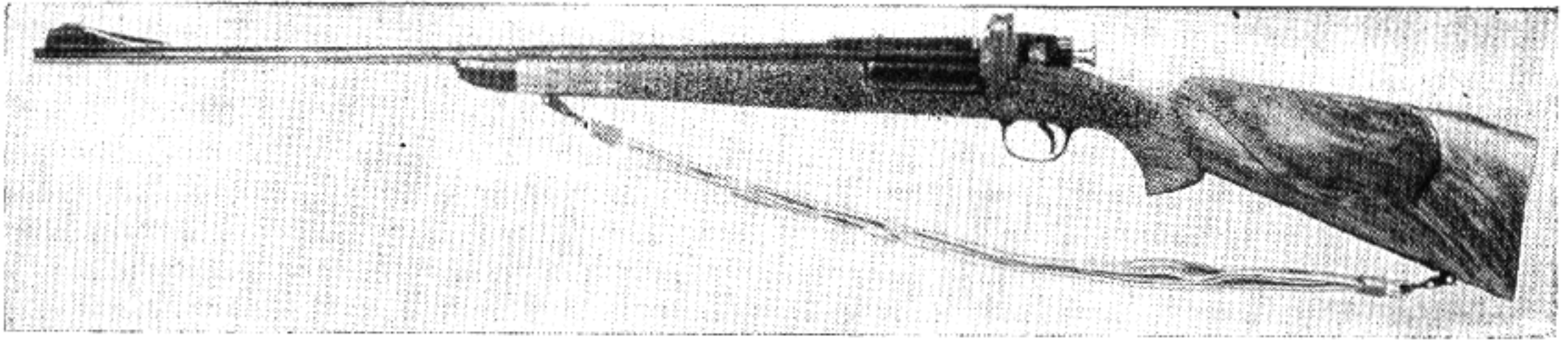

Fig. 54

Restocked Krag rifle. Model 1898 Springfield. Beautiful stock of richly figured Circassian walnut. Note perfect structure of grain in the wood

streaked with brown. For any one who likes red, this class of wood has the proper shade with dark streaks.

Persimmon Wood — Weight 49 pounds. North America. This is the ebony of America. Persimmon wood is the most suitable for shuttles, because it wears smooth, is hard, strong, tough, and of the proper weight. Sometimes the amateur gunsmith is a golf enthusiast, and it is a hard matter to find a better wood than this for golf-club heads. Very rarely a few pieces are found that have a handsome marking of light yellow, brown, and almost black streaks. The nearest resemblance to this can be found in a selection of highly striped ebony or coromandel wood.

Plum — Weight 54 pounds. Europe. There are many wild species of plum, but all are more or less similar. It is a very handsome wood and is not valued as highly as its undoubted qualities deserve. It is a reddish brown with darker and lighter streaks of the same color and is occasionally varied by some yellow. No tree of this nature should ever be wasted or burned, even in America, as it frequently can be used by the gunsmith for some decorative work on gun cabinets and to carry out other ideas which come along from time to time.

Rosewood — Weight 53 to 65 pounds. India. It is generally known as East India rosewood or as Malabar or Bombay rosewood. It is also occasionally termed Bombay blackwood. The color is variable, ranging from light red to a deep rich purple, and streaked with every shade from golden yellow to almost black. The chief use for this wood is for furniture, as it takes an exceedingly fine polish. It is so heavy that it is seldom used solid in any but small articles, and is known to us chiefly in veneers. It is very hard to work, is brittle, and far too heavy for gun stocking.

Satinee — Weight 54 pounds. French Guiana. This valuable highly decorative wood reminds one of curly maple, except that it is of greater beauty. The color is a light red which bleaches a little and assumes a very bright luster or sheen, especially when treated with a thin transparent polish. There is always a slightly marked, narrow shade of roe caused by the contrary soft and hard grain. With this figure in the wood, beautiful stocks can be made up—stocks to delight the person who has a liking for fancy maple.

Walnut, European — Weight 40 to 48 pounds. N. W. Himalayas, 41 pounds; Sikkim, 33 pounds. Great Britain, France, Italy, Turkey, Caucasia. India, China.

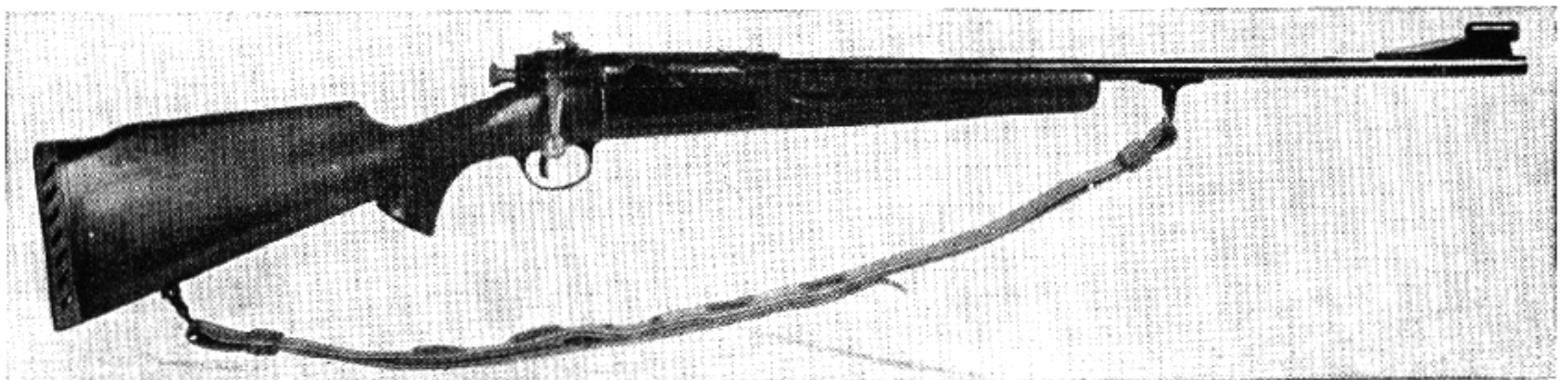

Fig. 55

Model 1898 Springfield remodeled. Wood, very plain piece of American walnut

In color this varies from light grayish-brown to dark brown. It is often traversed by black and golden or golden-red streaks and stripes, or is beautifully mottled and shows a wavy, roe grain.

Walnut requires some time to season, and shrinks considerably during the process; yet when subsequently exposed to drying or moistening influences it stands up excellently, and it is exceedingly difficult, if not impossible, to find another wood possessing this attribute to the same degree.

growths showing black lines which curve and twist into fantastic shapes. These forms are what is termed "blister" or "snail" figure. Other unusual markings also occur. The color is somewhat similar to that of French walnut, but it nearly always has a golden tinge. By careful selection, a yellowish brown or golden tint can be obtained which is quite unique. When this wood is carefully selected it makes a very fine rifle or shotgun stock, rather light in weight.

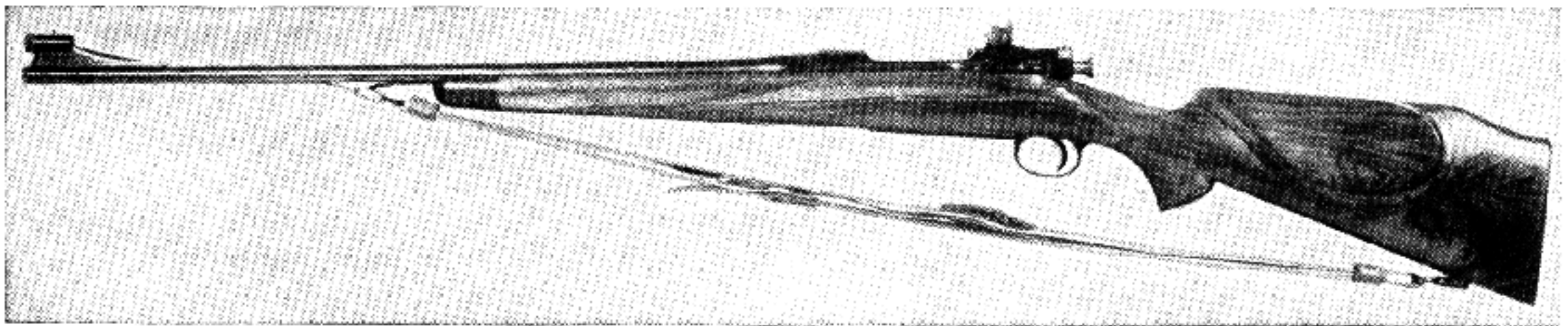

Fig. 56

Model 1903 Springfield rifle remodeled into sporting type. Stock of French walnut, not of the finest figure, yet not lacking in character

For this reason it is the best wood known for shotgun and rifle stocks. After the stocks have been cut out and shaped, the wood retains its form and shape exactly, so that the rifle barrel and receiver or the shotgun locks will drop into their position and rest without bending the locks or throwing the barrel out of line. No variation in climate affects this.

The combination of characteristics which confer on walnut its reputation of being far the best wood for gun stocks may be summarized as follows:

1. Relative strength, toughness, and elasticity, which provide the power of resisting shock.
2. Appropriate weight, which gives proper balance.
3. Relative freedom of the seasoned polished wood from any shrinkage, swelling, or splitting when exposed to wetness, dampness or heat.
4. Uniform texture and appropriate hardness, so that the wood is readily cut into delicate shapes, yet yielding a smooth surface which is easily plugged by polish.
5. Hardness necessary to prevent the wood from being dented.
6. Lack of brittleness or tendency to split, which decreases the danger of fragments of wood being knocked off.

African Walnut—Weight 30 pounds. West coast of Africa. The woods which are obtained from Benin and Lagose show a large portion strongly marked with stripes or roe, which, tho sometimes straight, is more often broken up into irregular

Black Walnut—Weight 37 pounds. North America. This wood is so familiar in this country that a detailed description would almost appear superfluous. The color, which is of a more uniform tint than the European wood, is a rich purplish brown. The beauty of the color is apt to deteriorate under the unfortunate and ill-advised use of shellac or French polish as employed by some of the arms companies; altho admirable for some woods, this is quite out of place with black walnut. A limited quantity of burrs or "burl" is still obtainable at extraordinarily high prices. During the European war, black walnut, besides being largely used for rifle stocks, was employed to a great extent for propeller blades for aircraft. The demand was so great that supplies rapidly diminished.

The black walnut that comes from Texas, California, and other States that have a hot dry climate, is the best. The black walnut that comes from Ohio, Pennsylvania, New York, Iowa, and other States where freezing weather occurs, is a very dark, porous wood. When working such wood you will notice in the sunlight a fine crystal effect. The walnut that is grown in the warmer climate and does not freeze has the finest grain, is much harder, and of a lighter figure, providing it is grown on the high ground away from water where the soil is more or less rocky. Consider the stocks on the Springfield service rifles; this class of wood is called the "Mississippi river bottom walnut"; it is porous, a quality due to the low swampy ground and a quick growth. This is a very familiar tree

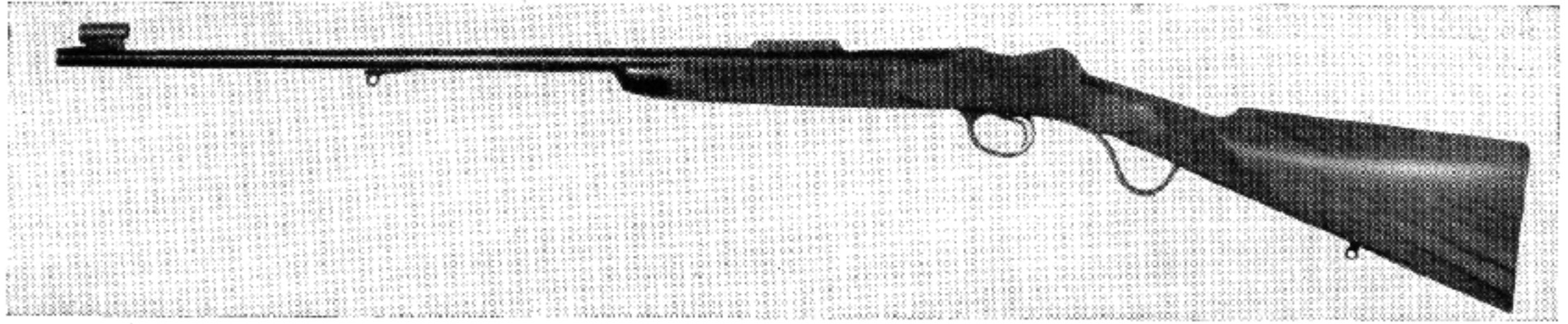

Fig. 57

Caliber .22 made on a Martini action. Turkish walnut. This wood is very dense, hard, and straight-grained

in the rich lands of the Mississippi basin; but because of the locality in which it is grown, the wood has a figure that is not the best for gun stocks in which you would take great pride. From the standpoint of beauty there is not a walnut that can compare with the foreign woods. True, some American or black walnut has a wonderful figure, but still you do not find the rich color that you do in the Circassian, French, English, or Italian walnuts. These are more expensive, but are well worth the difference because of the dense grain and strength of the wood. Whenever one wishes the best, he seeks the best, regardless of where it comes from or what the price. Black walnut is all right in its place as a beautiful piece of wood when given the special finishes supplied by all the gun manufacturers, but if you try to secure a fine oil finish, it becomes very dark and loses the effect it had before the oil was applied.

Circassian Walnut—In England the Italian walnut has always held the reputation of being the finest in quality, color, and figure; nevertheless, by far the largest part of the best wood in all respects is that coming from the Caucasus.

The walnut imported from Circassia has long been the best, and especially that Circassian which actually comes from the district of Poti. This supply of late years has been much reduced, and most of the so-called Circassian walnut has in reality been Georgian, Mingrelian, Imerethian, Gourian, and Abasian, all coming from districts

much farther east and farther distant from the seacoast. The traders in wood in these countries have been generally very astute, and it has been exceedingly difficult, unless the trade has been carried on by Englishmen, to discover the real source of the supply; as a result, many disputes and difficulties have arisen. Every year the supply becomes scarcer, while the quality deteriorates so that the walnut of the better class will soon become unobtainable unless some new source of supply is found. This is the case with other valuable figured woods, as the greater part of the wood finds its way into furniture and similar work.

Without examination of a great many samples of each kind it is impossible to distinguish any structural features characteristic of the wood of different countries, for in the same country the wood varies considerably both in this respect and in weight. When you are working Circassian walnut you will find that you can detect it among other walnuts. Circassian walnut is one of the best woods for gun stocks, as it has that rich brown color with the dark lines well broken; and when you have a gun stock made from a piece that shows a coon-tail effect together with a mottled figure, you have one of the most beautiful stocks that can be secured. I use more of this class of wood than any other for gun stocks, because even in the lower grades the color is pleasing to the eye. Naturally, the British control the available supply of this wood for gun stocks, but you can secure from

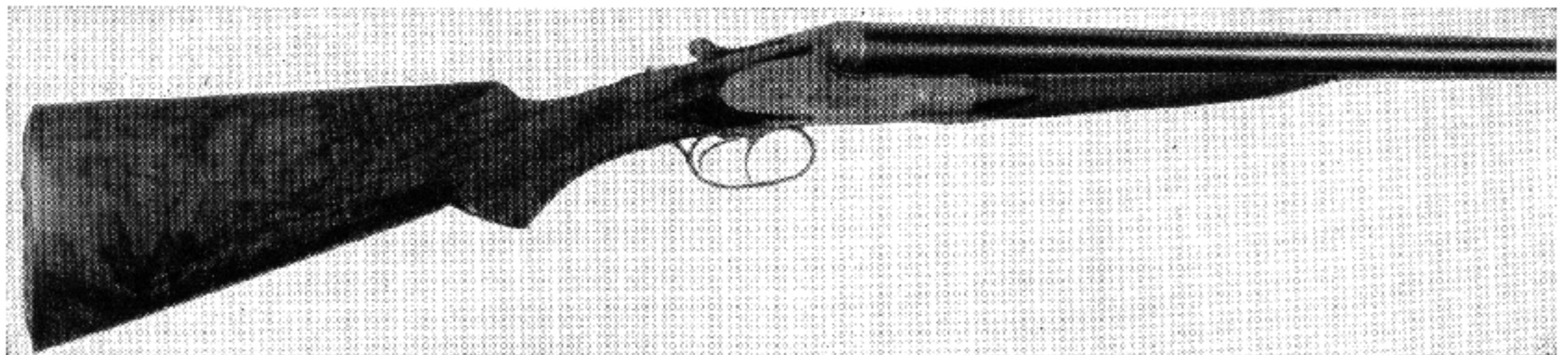

Fig. 58

Francotte 12-gauge double shotgun. Stock of beautiful Circassian walnut, colors ranging from reddish orange to black. Wavy character on both sides

England blanks of this wood at prices ranging from four to forty dollars, and as the British are most upright people to deal with, you can always expect to receive true value.

East Indian Walnut—Weight 47 to 60 pounds. India. It is a hard, dense, close-grained wood of a dark brown color, with black and gray streaks. It usually has a curly, wavy grain. Often it contains the characteristic figure of mahogany which is commonly known as roe and mottle, sometimes with a very pronounced and strongly marked fiddle mottle. The wood has a smooth yellow appearance. It has been used in this country for decorative work and furniture, especially by the Pullman Company in coaches, where it is known by the names of Koko and Laurel wood. It is not, however, suited to some of the purposes to which European and American walnut is put—for rifle stocks, for instance. It is too hard, brittle, and heavy.

English Walnut—A native of the temperate regions of the northern hemisphere. The nuts of the various species are well known. The wood varies considerably in quality, texture and color, according to the place and soil on which the tree grows. A much larger proportion than is usually recognized of finely figured, blood-colored British wood can be obtained. Its commercial culture in this country is practically confined to California, tho it is grown in widely scattered sections of the country. A hardy variety is grown in Oregon. The English walnut of Europe is of the same species and shipped under the trade name of English walnut. As this wood makes very fine gun stocks, it remains one of the most valuable of woods. Having in mind the world-wide demand and universal depletion of supplies, the planting of walnut trees should have an important place in any future scheme of reforestation. For those who live in a suitable climate with land available, what better plan could be carried out than to plant these

trees along the line fences for future generations? It is far better than a trust fund for those who are to inherit such property.

French Walnut—This wood is for the most part light-colored and straight-grained. The relatively small amount of finely figured French wood available is practically all absorbed by Paris and Marseilles for veneers. Recently a great amount of decorative architectural work has been executed in plain French walnut. The quiet gray color and straight grain produce a dignified and restrained artistic effect and particularly suit the modern style of cabinet work. You can always tell the French walnut that comes from the southern part of France, as this part of the country produces the finest, and when it is possible to get a blank from this source of supply you must pay a high price for it.

Italian Walnut—While this is most generally named in architectural and other specifications, it is actually very rarely obtained. Formerly it included a large proportion of dark-grained figured wood, but of late years supplies of all kinds have been greatly reduced and the quality in all respects has very much deteriorated. What little Italian walnut is available is of poor quality; it is much better to use the best of Circassian walnut for the finest gun stocks.

Spanish Walnut—A regular but not a large quantity of wood has been imported from Spain. The general quality and conditions are the same as the French, from which it is difficult to distinguish, except that on the whole the shipments have consisted of sizes more irregular in width and length and contained more faults with a much larger percentage of sap-wood.

Turkish Walnut—This most nearly resembles the French walnut, but includes a greater proportion of figured wood. The last shipment coming into this country which I examined was a poor grade, and when a well figured stock was found



Fig. 59
A Charles Daley three-barreled gun. Stock of plain figured French walnut

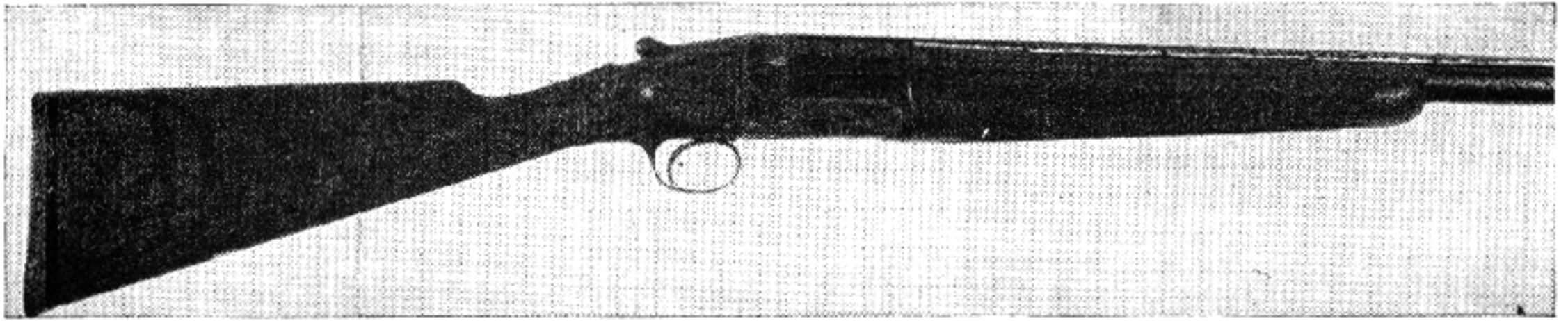

Fig. 60

Joseph Lang 12-gauge trap gun restocked with fine Italian walnut. Character of wood presents wavy appearance in certain lights

there was always a very definite defect somewhere.

Yew, British — Weight 48 to 50 pounds. Europe.

The color is a pale red somewhat like cherry-wood or pencil cedar. It has a beautiful, smooth, lustrous grain. It is sometimes beautifully figured and occasionally has a burr growth. The product will compare favorably with Amboyan, and has often been mistaken for it. The strength and elasticity of yew wood has been known for centuries particularly on account of its use for bows, and of course a number of amateurs who work on guns also make their own bows, so with this wood in mind you have the best, providing you can secure the fine strong grain. As yew wood ages it becomes as hard as steel and has a dark beautiful color.

You may not only secure the well seasoned wood in blanks, but you may also wish to secure the wood in the log as well and season it yourself. So it is well to have a clear idea as to the meaning of the term "seasoned," as particularly applied on one hand to a piece of wood, small in thickness, and on the other hand to a log or beam. The small piece when seasoned is more or less dry from the outside to the core, whereas the wood of the "seasoned" log is by no means necessarily so. This latter fact is rendered comprehensible by a consideration of the sequence of events during the seasoning of a log. While the log has been exposed to sufficiently dry air, it loses water by the evaporation which takes place over the whole surface, but most actively at the two ends. When the bark is left on the log, evaporation is excessively slow, save where there are cracks or at the ends. As the moisture is lost at the surface, the drying-up superficial wood receives water from the interior. But as time goes on, it receives less and less; the log then, when protected from outside moisture, assumes a condition in which it is relatively dry externally and relatively moist in the middle. This condition may endure for years, possibly for decades if the wood is dense. Thick walnut trunks when cut open after being stored indoors for years

are often found to be thoroughly wet in the middle. Even if such logs are described as seasoned, their wood cannot be so described when the log is cut up. The resulting pieces, including the moist center wood, will shrink and are liable to split in the same manner as unseasoned pieces. Yet such "seasoned" logs are very different in properties from freshly felled specimens. This is clear when it is remembered that:

1. Deformation, warping, and cracking are in the beginning caused by premature rapid drying at the surface.
2. Dry wood is stronger than wet wood, and in mechanical structures the important matter is to have the external part strong.
3. Wood-destroying fungi, causing rot, gain entrance solely through moist wood.
4. It is possible that wood seasoned slowly is superior in mechanical properties to wood rapidly seasoned. It is also certainly less liable to split during seasoning.

Thus the seasoned blanks on all gun work, when obtained from the dealer as seasoned wood, should be placed in a warm, dry place and not used for a considerable length of time. You must understand that gun work as a hobby is not taken up merely for six months or a year, but is continued over a period of years. There is evidence that wood first partially seasoned in the bulk and then fully seasoned after being sawed is much inferior to that which is felled, brought straight to the saw-mill, sawed at once, then seasoned. It is far more economical to season blanks and small pieces in the latter manner. The time required to season walnut properly varies so greatly according to the different kinds and sizes and the position in which it is placed, that it is impossible, almost, to lay down any general rule. A very rough manner of reckoning has been generally accepted, which allows one year for each inch of thickness, but this is not reliable.

The question has often arisen, Which is better—natural or artificial seasoning? Artificial seasoning having now been presented, comparisons can

be made between it and ordinary air seasoning. The question must be considered both from a technical and a commercial point of view. It is in fact practically impossible either for the professor with his microscope or the practical timber man with his knife to tell the difference between naturally seasoned timber and properly artificially seasoned timber, if the surface is planed off. Naturally the chief technical advantage of artificial seasoning is that it is possible to obtain with considerable precision any degree of dryness which may be required for a particular purpose. For gun stocks we must have the walnut completely dry, so that there can be no possible chance of shrinkage. In the light of commercial interest there are arguments favorable and unfavorable to be adduced. The solution rests less in discussing this disputed question than in turning to consider which type of seasoned timber is of the greater value. It is well known among those who have carried out high-class work, that besides making every effort to keep a sufficient stock of thoroughly natural seasoned wood, one should always see that the wood undergoes a certain amount of artificial seasoning before use. Of course this question rarely affects the amateur who secures only a small amount of wood, but it is for the man who figures far ahead and has the proper place for the natural seasoning, such as an attic or a place where a fine circulation of air is possible. As supplies of different wood are added, they are to be labeled with the date so that a complete record can be kept.

When selecting blanks from high-grade pieces of wood in the log, it is far better to consult those who know the proper method to quarter-saw and board-saw the timber, for if you do not saw these for figure and strength, you will note that the quarter-sawed planks have the edge grain presented on the flat surface, while the others have the edge grain on the edge with the layer carried by the annual ring formation showing on the flat sides. Edge grain as presented in the quarter-sawed plank is stronger if the strain is brought to bear against the flat sides. Since the strain on a stock usually comes in the direction of the bend at the pistol grip, it is found that the board-sawed planks are better adapted to resist the strains at that point. But if one so wishes, quarter-sawed planks can be selected to obtain the finest results without any danger of breaking as explained. Walnuts have a great margin of strength, particularly when the stock pattern is correctly laid out on the wood with due consideration for the direction of the grain. You will find places where you can lay out your pattern to secure the curly twisted grain coming up to the grip and out from there, a straight grain

going to the end of the forearm. Your choice may be the board-sawed to secure the opposite effect. With these facts in mind, selection is a matter of individual taste. Figure 61 shows patterns to be used when cutting blanks.

In cutting a blank from a plank, always make use of a templet. This you can cut from a piece of thin, soft wood. By using it you can prospect your plank in all directions and decide how best to cut your blanks. You will not only be able in this way to get straight grain in the "hand" of the stock and figure, where figure shows to the best advantage, but by reversing your pattern you will be able to see just where you can save lumber and get results. This is very much safer and easier than guesswork. A perfectly sound tight knot, if surrounded as it often is by fine markings, is not entirely objectionable in a stock, but you will see, of course, that it does not occur where strength is needed. Your templet will enable you to judge this perfectly.

Checkering and polishing are two operations which must always be in one's mind when one thinks of stock wood. Good sharp checkering is almost impossible in open-grained, soft wood, and when it comes to the modern and durable oil finish, you will find that the work of getting a surface and a polish is primarily in getting the right kind of wood. This last operation is far from being an inexpensive one, and the saving in labor easily pays for more costly but suitable wood. Incidentally, I might say that your checkering will be determined in some degree by the material you are working on. Don't attempt too fine a checker on open-grained wood: this applies to American walnut. A shallow checker with obtuse grooves will be easier and safer. Only in firm and dense woods will fine checkering be possible and suitable.

The virtue of planting trees has long been recognized, and is daily being stressed by organizations, societies, and various smaller circles. Forest preservation is taught directly or indirectly in every school, for timber is one of our greatest natural resources, and it is rapidly disappearing. If we turn back the hands of the clock, many of us will see ourselves as small children, listening to the story of a very wise man who planted a fig tree for his children and grandchildren. The man who owns land today—and it does not matter in what part of the country it is located—may wisely plan reforestation with black walnut or the hardy varieties of English walnut, for the supply of these, more than any other, is rapidly diminishing and the demand is ever increasing. The virtue of such men will always be recognized; they create a veritable trust fund for those they leave behind.

For those who wish to embellish a stock with inlays (it always seems to us a sacrilege when rich walnut is the foundation), some of the rare woods are suitable and decorative when used with ivory, ebony and ivory particularly being very effective when judiciously applied. I question, however, if ebony is as good as bakelite or buffalo horn when one wants black for any purpose.

Stock blanks run from about \$3 for plain sound wood to almost any price one wants to pay. Really fine-figured, full-length rifle blanks of choice Euro-

pean walnut will run from \$20 to \$40 and are worth it. You must and will, however, "cut your garment according to your cloth."

In the Directory we give the names of reliable firms from which walnut can be obtained. Those firms we list we know from personal experience to be reliable. State your price limit and you will get the best which that limit will buy. In other native woods we can offer little help. Your local lumber yard and planing mill will have the information and perhaps the material you need.

CHAPTER VIII

Designing the Gun Stock

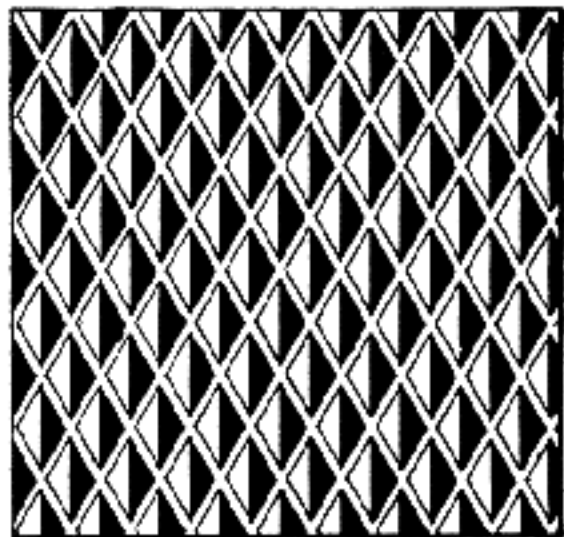

Designing the Gun Stock

IN CONSTRUCTING a gun stock, design is a very important point; the lines must be graceful curves, and conform to certain basic principles. When the stock possesses these qualifications it will give its maker that satisfying sense which we associate with a work of art. In an article, however, as highly developed as a gun, there is now not much room left for individual expression, particularly in design, for master minds during several centuries have gradually evolved outlines which have become established in our consciousness and set a standard of taste and utility. Only as to applied ornamentation is there really scope for new expression, and this necessarily is limited. We therefore cannot give the amateur better advice than to "hitch his wagon to a star," choosing for his star the work of a master gunsmith.

In reviewing the evolution of firearms and tracing this wonderfully interesting subject through the centuries, we find that the earliest shoulder gun was an unwieldy affair; it was really a small cannon lashed upon wooden scantlings. These forms can hardly be called hand guns because of the inability to use them except in conjunction with a forked support thrust into the ground to sustain their weight. With the progressive development of explosives, lighter barrels became possible, and by the time of the matchlock the stock or "stalk" had reached back to the shooter's shoulder. These, in the intervening centuries, approached gradually our understanding of accustomed lines, but were remarkable because of their excessive ornamentation rather than a worthy advance in design. The development of the stock, as we know it today, was very largely the work of that greatest of all gun-makers, Joseph Manton of London, who lived a century ago and brought the shoulder gun to such perfection that it could be used efficiently on moving game.

The problem of "fit" is of paramount importance, especially when we realize that most of the process of aiming must be done subconsciously. There are comparatively few shooters who appreciate this fact and are not under a continuous handicap in their effort for advancement. It is not difficult to determine the fit or misfit of a gun. Select some object, at a distance over which it is

clearly discerned, preferably with a background that will bring it into bold relief. Stand in shooting position opposite this, visually determine its exact position, close your eyes, and bring the gun quickly and naturally to your shoulder, aiming blindly at the mark on which your eyes were fixed. Then open them and see where your gun points. Do it several times so as to avoid any unusual stance, and if your error is consistently repeated you will see exactly what is wrong. It may show that you are shooting high, which means too straight a stock or too high a comb; or it may show that you are shooting low, which means too much drop; or to the left or right, which signifies the need of "cast-off." Length and pitch of butt will also be apparent in the ease or difficulty with which the gun is alined. To determine actual measurements it is highly important to take into consideration the build and anatomy of the shooter. The tall, long-armed man will require a longer stock than one who is compactly built; and drop or bend will be similarly influenced.

In a shotgun, let it be remembered that when you see only the top of the action in aiming, you will be pointing too low, whereas, properly, the last few inches at the muzzle should be in line with your quarry. Determine well these two facts before deciding the correct drop of your stock.

There is a tendency, I am certain, in most shooters, toward a too liberal bend in the stock. Nothing is so conducive to an annoying recoil as too much drop. It should be understood that recoil operates in a direct line with the long axis of the bore, the gun meanwhile being converted into a lever with the weight at the shoulder and fulcrum at the point of drop. Trap shooters know this and are not slow in taking full advantage of it. The straightest possible stock consistent with a minimum in drop would suffice if game guns were used exclusively for bird shooting, but as ground and running game must be considered, we are driven to a compromise.

For deliberate shooting, such as at the trap or at stationary targets, a stock which is a mite too long is preferable, for it minimizes recoil and has a tendency to keep the gun well up; but in the marsh, when one is bundled up with heavy clothes,

a long stock would be a distinct disadvantage.

When I construct a new stock for a customer, I request him to go through the performance of aiming at an object in my presence in order to arrive at a definite conclusion as to his style and shortcomings. If he repeatedly places the butt too high I know forthwith that he needs a more generous drop, the amount of which may be exactly determined as the shaping progresses. As in the case of a suit of clothes, if the customer is available during the course of the work, there may be a greater number of fittings and a better chance of an ideal result.

Instinctive, correct aiming is what we are after. This saves time and speed in getting on your mark if it is in motion; it is of vital importance, since the vexatious problem of holding ahead, above, or below increases with distance.

The position of the head in relation to the right shoulder obviates largely shooting to the right, unless the left eye is the stronger or "master" eye. This is a more difficult error to rectify in stocking. It is true that cast-on, which is the swing of the butt to the left, is possible, but the distance between one's eyes is considerable, a feature which, when compensated for in the stock, distorts it and produces an unsightly result. I think the stock maker is well advised to encourage deliberate holding in this case. To learn shooting from the left shoulder may well be the better plan.

One point which is frequently overlooked in stock design is "pitch," or the angle of the butt to the gun. This is a very essential point, for altho one may have everything else in perfect balance, this simple fault may cause over- or undershooting. When a gun is made without pitch, it overshoots for some, and when it is made with too much pitch, it undershoots. Again we have to consider the type of build of the shooter. The man who is more or less thin-chested must have less pitch or none at all, whereas the erect person with a full cheek must have considerable pitch. I have found that a person with the latter build requires a pitch of between 3 and 5 inches in shooting a 28-inch barrel. In all cases, however, one must not forget

the importance of a correct stance in the act of firing. Some stand in an awkward posture, and in such instances a correct stance must be acquired as a preliminary to correct gun fitting. The gun must not be expected do all the courting.

Strict attention should be paid to the proper balance or to the center of gravity of the arm when the stock is being constructed. The center of gravity must be determined by hefting and can only be checked by the feel. When a gun balances well the arm is far easier to handle and carry. If the stock is too light, by removing the buttplate, lead may be inserted to advantage in the butt at the toe.

Warning must be given the beginner that making a stock is not the simplest task in gunsmithing. The change between metal working and wood working is so great that you really have to be two mechanics in one. Yet it adds a very pleasant variety to your work when you have mastered the difficulties. Try not to let one branch suffer at the expense of the other.

If the stock is not fitted to the action perfectly, there results an opening between metal and wood which in every instance appears exaggerated. The fitting of the receiver, action, locks, guards, etc., must be done with care, precision, and perfect contact. All metal parts must be in close alinement with the wood, yet easy of removal or insertion.

The forearm or the left-hand grip of a stock on all standard shotguns has not been given much thought except in the case of trap guns. These have been improved by a flat, beaver-tail effect, which fits the palm of the hand and is rather pleasing in appearance.

In a double gun, owing to the width of the barrels, there is little room for improvement. For formal shooting, such as at the trap, an enlarged forearm can be advantageously constructed; for field work it is questionable if improvement is possible.

A study of the position of your hand in the act of holding will reveal a twisted effect which is very uncomfortable. Figure 62 shows a design of forearm to facilitate comfortable holding, as it re-

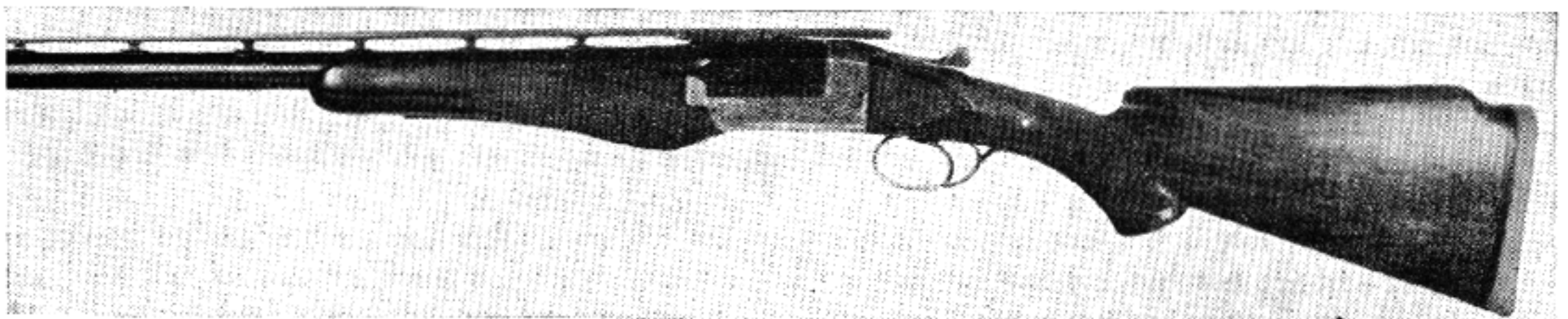

Fig. 62

Francotte 12-gauge trap gun stocked for the shooter's holding comfort. Note the unusual forearm and removal extension rib



Fig. 63

Restocked caliber 30-06 Newton rifle made with a close pistol grip and thumb rest back of the bolt handle. Designed for persons who have lost the use of certain fingers through accidents

lieves the muscle strain when the left arm is extended. True, when it comes to graceful outlines, it is rather out of balance, but it is practical and worth consideration.

When a pistol grip is added to a well formed stock it should blend perfectly into the lines of the design. Pleasing, graceful curves may be achieved here, and they can either help or detract to a degree that does or does not spell approval. A pistol grip on a rifle adds greatly to steady holding, providing, of course, that the grip is shaped to fit the hand and is properly placed.

Sometimes I think we are in danger of going a bit too far in what we call "close" grips. Our anxiety to get away from the useless pistol grips of yesterday has led us to another extreme. A grip too close and too pronounced certainly does not look well, and, in my opinion, restricts the free movement of the hand, especially in the operation of mounting the piece to the shoulder. Figure 63 shows a very close grip made for a man who had lost the use of three fingers and retained very little sensation in his index finger and thumb. Note the thumb-rest at the side. A stock design such as this is unusual, of course, and requires individual thought. There is no set rule to follow in the designing of a pistol grip, for hands are of different shapes and sizes. In the case of a shotgun stock the owner must be guided by personal requirements often known only to himself. When a person uses both rifle and shotgun, he may not want to be without a pistol grip on either, because he prefers that the "feel" be the same. When designing a full pistol grip on a shotgun, do not round the end of the grip as on some of the cheap European guns, but finish it in the same way that you would a rifle

grip, except that you should carry the lines down much finer; it adds to beauty to have a cap of buffalo horn.

There are other faults aside from those just mentioned, and in your shooting education you will not discover them all at one time; hence you will find it necessary constantly to check and analyze the reasons why certain errors persist. The stock is not the whole gun. Rib, barrel, trigger-pull, sights, etc., must all be under observation for possible correction.

The correct method for estimating length of stock is first to place the latter in the hollow of the elbow, flexed to an angle of 90 degrees. If in this position you can reach the trigger comfortably with the index finger, between its end and the first joint, the stock will be about right in your case. For shotguns used at the traps, add from $\frac{1}{4}$ to $\frac{1}{2}$ inch in length. For rifles, $\frac{1}{4}$ inch or less will be comfortable. This practise is by no means infallible, but it is a convenient procedure in determining the approximate length. Only actual trial will really settle the question.

I have merely mentioned the target shooter so far, or the designing of the proper stock for his style of holding. This subject is a never-ending one, for of all the stocks I have made and built for this class of shooter there have never been two alike, and their requirements vary to the same degree—they are in a class by themselves, and with the trap shooters comprise the genuine gun cranks. One day I extend the stock, the next day add a cheek piece, and on another day remove the extension and bring the stock back to the original length. The following week the cheek piece is removed, and another extension glued to the butt stock; and the

following month a new stock is made, only to be butchered up again. Under no consideration would I permit myself to express unbending individual views on the proper designs for a stock which will suit the target or trap shooter; there is no such thing, except as suggested in Figures 64 and 65. The enthusiast has to analyze his own requirements, and build airy dreams which never quite materialize, but give him endless pleasure. Bless his heart, he is the fellow that keeps us gunsmiths from the poor-house and up on our toes.

Having discussed the outstanding points, it is now in order to touch upon measurements of parts which enter into the design of a stock, with final measurements on forming and shaping. The latter will be treated fully in another chapter.

Stock Nomenclature — Before going further into a consideration of the essentials of rifle-stock

the measurements taken from below instead of above.

On a game rifle, the sights are usually set for 100 yards. Length measurements are made from center of the front trigger to center of the butt plate; *bc* measurements are taken to the outer surfaces. The measurements from trigger to heel or toe vary in different instances. Length of pistol grip is measured from center of the trigger to edge of the grip cap, *c*. Most important are the measurements given in Figure 67 in relation to the correct outlines for pistol grips, regardless of the length from the center of the trigger to the edge of the grip cap. These measurements have a great deal more to do with the feel and handling of the gun than the distance; such measurements will answer for both shotgun and rifle. When constructing a rifle stock refer to Figure 84.

The line *H-pi* is at right angles to the line of

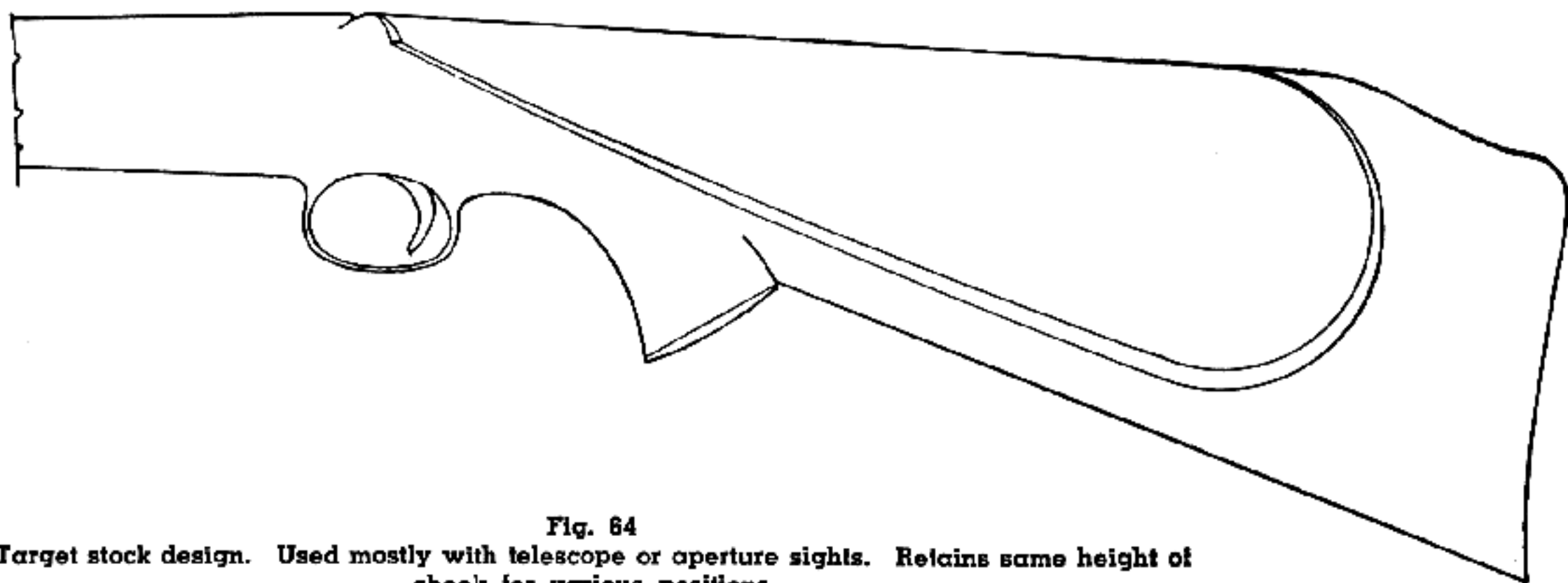

Fig. 64

Target stock design. Used mostly with telescope or aperture sights. Retains same height of cheek for various positions

design, study Figure 66. If you are not already familiar with the nomenclature of a modern sporting stock, *A* is the fore-end or forearm. *FT* is the forearm tip. *G* is the hand grip, or upper part of grip. The British gun makers call it the "hand." *PG* is the lower extension of hand grip or pistol grip. *CO* is the comb. *C* is the cheek piece. *B* is the butt stock. *H* is the heel. *T* is the toe. Gun makers include both comb and heel when measurements are taken; this is necessary, for altho comb measurements are pretty consistent, there are variations. The line *S* represents the line of sights reaching from the front sight at muzzle, resting in the center of the rear sight and running to the extremity of the butt.

When taking the measurements of a shotgun, a straight-edge resting evenly upon the rib, and extending from butt to muzzle, provides the best medium. If a straight-edge is not available, the gun may be inverted, rib downward, on a table, and

sight, and the distance *pi* to the toe *T* determines the "pitch" of the stock, if any. (Pitch means the distance of the front sight from the perpendicular when both heel and toe of butt plate are resting on a horizontal surface, i.e., the floor.)

When a stock has no pitch, it often causes the user of the gun to shoot high; this is because the toe gets a maximum amount of pressure under the shoulder when the gun is brought to the firing position.

In contradiction to a stock which has too much pitch, we have the opposite extreme, that which causes the gun to undershoot. The same rule applies to shotguns as well as rifles. Pitch has very little bearing on prone shooting, but it is well to have a butt plate with more convex surface when using a rifle in this position since it provides a rigid support that is lacking in a straight one.

It seems unreasonable to the average person that the fault of too much or too little drop causes so

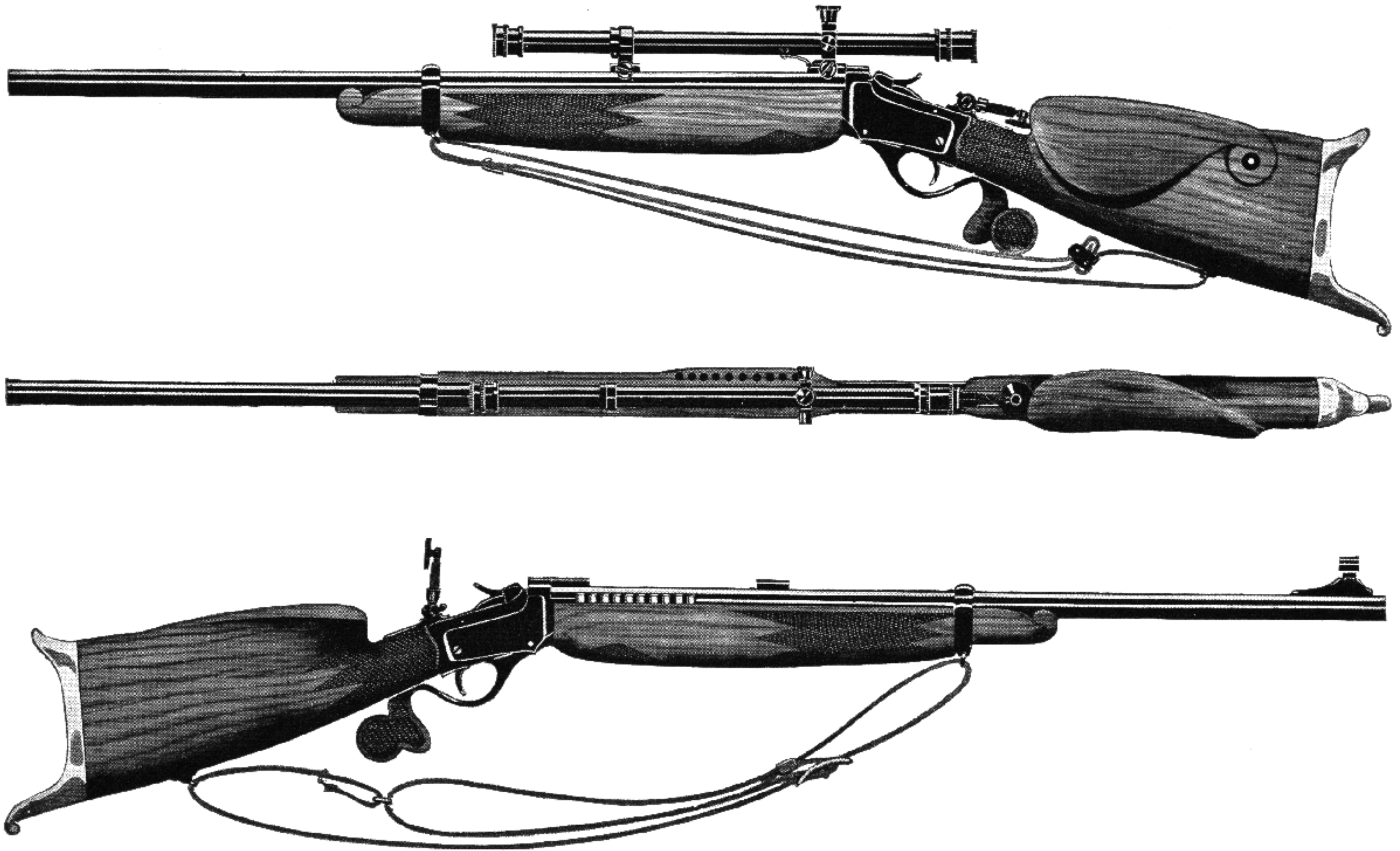

Fig. 65

Caliber .22 match rifle, single-shot Winchester action. Lyman 5-A telescope. Lyman iron sights. Carney target sling. An amateur's successful attempt to design a suitable stock for his own individual target shooting

vast a difference in shooting, and many novices fail to understand how the angle of departure of the bullet will be altered under these circumstances. With a stock made for a tall, long-armed person, the piece does not require any pitch. Let the short-necked, full-chested person shoot that gun and he will overshoot eight times out of ten, for the simple reason already mentioned—that there is too great a pressure at the toe. Vice versa, the tall, long-limbed person, using the short-necked and full-chested person's gun, will undershoot consistently.

When making a stock to fit a woman it is well to take into careful consideration the difference of physique in the sexes. Pitch and drop on account of perceptibility of recoil is here very important; also the position of the toe, which should be rounded and swung outward. The butt plate, in addition to the concavity from heel to toe, should be convex across its narrower direction; not as much for a shotgun as for a rifle, but enough to warrant a fit that conforms to outline of shoulder. We shall refer to this again.

The pitch of guns as usually encountered is between 3 and 4 inches, with as much as 7 and 10 inches for a heavy-chested person who stands very erect in the act of firing. This is presuming the barrel length is 24 inches.

The lighter the gun, the more recoil will be noticeable, but when a stock fits perfectly, the recoil will not seem so great, for you will feel it more when shooting a ten-pound gun with an ill-fitting stock than you will with a seven-pound gun with a perfect fit. For that reason I always recommend that the light rifle should have perfect balance and a well designed stock.

Cast-off — Looking at Figure 66, the small view of the butt end of the stock illustrates what is meant by "cast-off" in a stock. The line *g-g* is given by the vertical center line drawn between the front and rear sight to the exact center of the butt stock, and the cast-off is the amount *j-j* the stock is thrown off or out of line with the sights in a perpendicular direction. "Cast-off" always means that the central line of the stock is placed to the "right" of this lateral direction, when the gun is held in a normal shooting position. "Cast-on" means the distance the stock is thrown to the "left" of the perpendicular line. The man who shoots from the right shoulder requires "cast-off" and the person who shoots from his left shoulder requires "cast-on."

Cast-off or Cast-on — Drop at comb and heel, and length of stock, are naturally all dependent upon the build of a man and his physical deviations. This is a factor which the stock maker estimates by

experience. Too much cast-off will cause a gun to shoot to the right. The usual amount of cast-off is $\frac{1}{4}$ inch at the heel, and is about the correct amount for the average person. Some stocks have more cast-off at the toe than at the heel. When a shooter involuntarily cants his gun to the left, I bring the toe to the center line, with the heel between $\frac{1}{8}$ -inch and $\frac{1}{4}$ -inch cast-off. Remember when giving cast-off to a stock that the angle of the butt plate must conform to it so that seating against the shoulder will be correct. With a large cast-off, it is best to have a convex section in the butt plate. Figure 66 shows a stock blank laid out for a cast-off stock, *a-a-a* being the perpendicular center line, *b-b-b* the new line in a lateral direction.

Balance — The word does not do full justice to our understanding of the term. When a rifle comes up to the shoulder only with an effort, we say it balances badly, and as this is what we mean, let us continue to use the term until a better one is found. In designing a stock, the weight of the wood must not alone be taken into consideration, but the metal parts as well. In shotguns it is a very easy matter to secure balance, as you can either remove or add weight to the butt stock, and have the gun balance at a desirable point ahead of the trigger guard. In the case of rifles, with their comparatively heavy barrels, it is much more difficult, for we have many different types to consider. Some rifles balance naturally at the right point when remodeled, especially the Springfield, Mauser, Winchester, and Mannlicher, and it is fairly easy to secure the correct proportions of weight between barrel, action, and stock. On the other hand, our tubular magazine repeating rifles with full-length magazines can hardly ever be made to balance. That feature is very greatly aided and more easily obtained when a certain proportion of the total weight of the arm can be centered between the hands while holding. Extreme care must be exercised not to remove too much weight from the muzzle, for a muzzle-light rifle or gun loses the degree of stability which is essential in the act of shooting. The forward part of the barrel helps stabilize the piece while in position, but the exact proportion of weight that should carry to that of the whole gun must depend largely on the individual. Some men require distinctly more weight anterior to the support of the fore-end hand than do others. Again, some cannot use a short-barreled gun; others find such guns a great benefit, in that they provide added speed and proficiency in maintaining elevation, while many trap shooters still swear by barrels 32 and 34 inches long. We must confess that, to our mind, convention plays a great

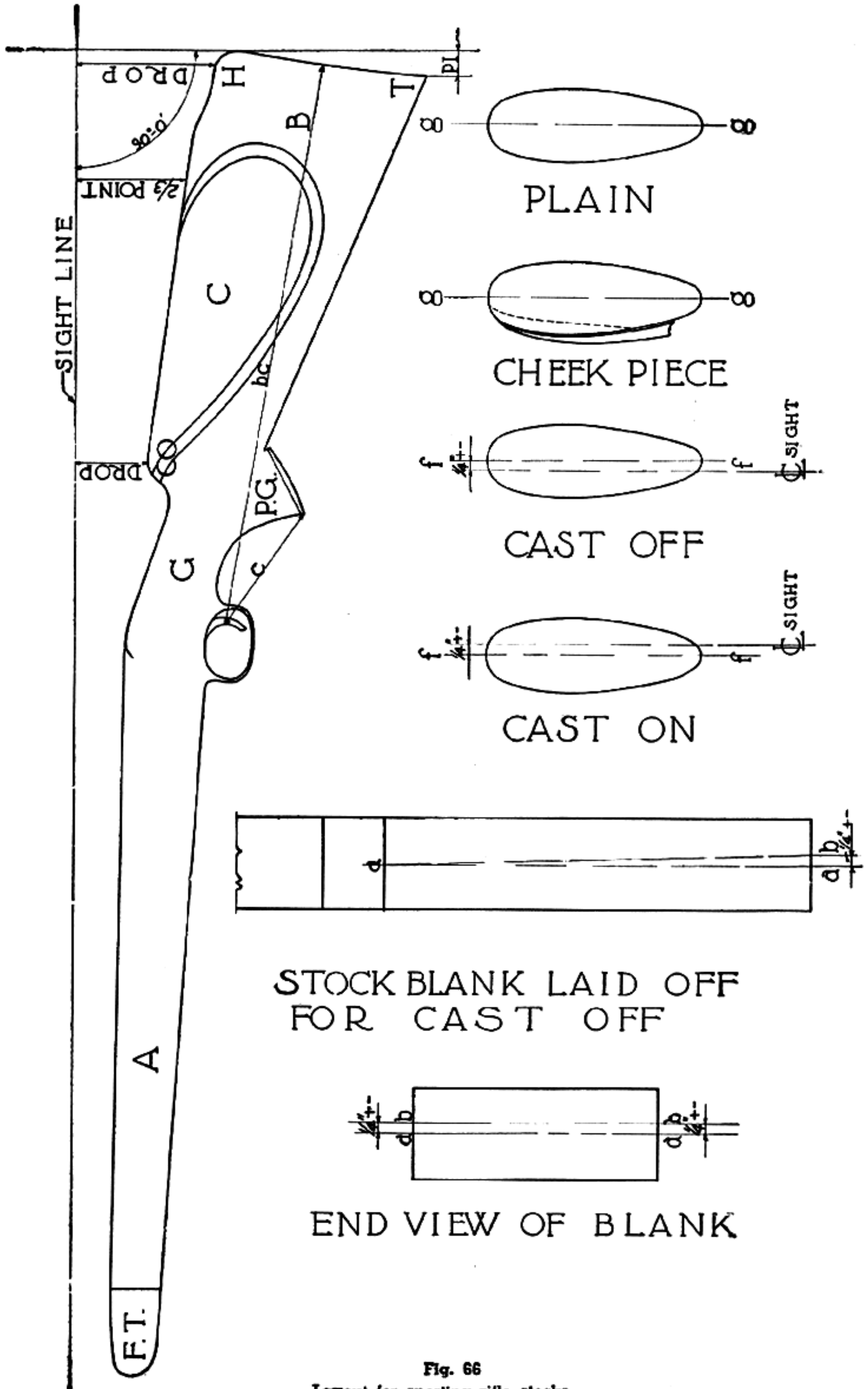

Fig. 66
Layout for sporting rifle stocks

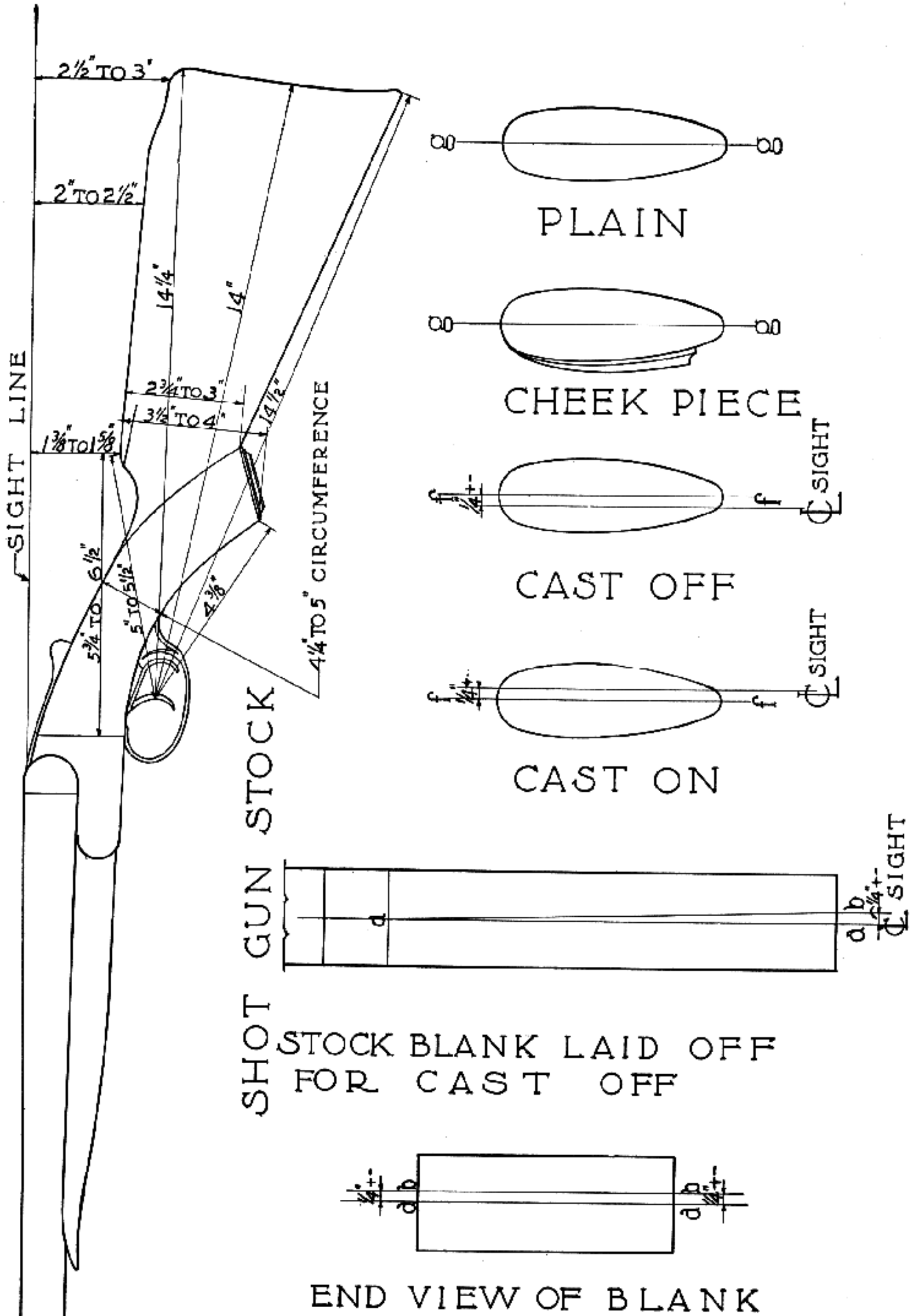

Fig. 67
Layout details for average shotgun stock measurements

part in this. A necessity of the black-powder days has persisted as a custom.

When it comes to balance, we have reached the point of perfection in our finest shotguns. For the better grades, the makers have studied this question from every angle, and whenever a person secures such a gun he may be sure of having it near to perfect balance. A like practise would improve universally the handling of many of our cheap guns. It is well known that many individual shooters and gun cranks require specially designed stocks; one for the prone position and another for the offhand position. This is, in a manner, justified, for a given rifle cannot excel in both cases. The rifle used in prone position does not demand balance, and muzzle weight is an advantage; but too much weight in this direction is disastrous in offhand work.

Butt Stock Design — All butts are fitted with butt or heel plates of different forms and materials; some are good and others unsatisfactory. The hard rubber plates furnished on standard arms are a poor makeshift and easily broken when subjected to hard usage. On the other hand, the steel curved plates of our commercial rifles are only a relic of our early American muzzle-loading rifles. Some prefer these plates because they do not slip so easily from the shoulder when one is working the lever or bolt in rapid fire, but their day is passing. The more modern steel butt plates which are made in Europe are by far the most practical, for they have the desired convex surface in the center and also the proper concavity from heel to toe together with the right length and width. Those made for the Mannlicher-Schœnauer rifle are particularly good. The correct measurement of a plate should be $1\frac{5}{8}$ inches wide and $5\frac{1}{8}$ to $5\frac{1}{4}$ inches long. The next choice of a heel plate is the compressed buffalo-horn plate made in England. The manufacturers soften the horn in some manner and then re-form it in moulds under hydraulic pressure. These plates are nicely designed in every detail so that they take up the effects of the recoil evenly. Third is the rubber recoil pad. This form of butt plate never adds beauty to a well-designed stock, but it is a boon to those who are sensitive to recoil, particularly in heavy double rifles when used in a hot climate, the shooter wearing possibly nothing more than a thin shirt. Recoil pads are a great aid on trap guns where many successive shots are fired. A pad on the well-designed stock of either a rifle or shotgun where the recoil is not very severe is not altogether desirable; it adds weight to the end of the stock, and tends to cling to one's clothes or stick at the wrong place on the shoulder. The friction can be overcome by cementing on a piece of leather

which is glazed on the outer side. Trap plates must fit perfectly, and it is therefore well to surface the bottom edge of the plate so that it and the wood will adapt evenly. When these plates are given the final shape in the forming die, the outer edge of the metal assumes a slight angle, ostensibly to secure an outside fit, but this must be filed straight with the stock so the butt plate will have continuous contact with the wood. When fitting any form of butt plate, it should be done in the same manner.

Bringing forward weight to secure balance is done by boring out the stock under the butt plate; you may find it necessary to enlarge the opening until only a skeleton remains. When this process is attempted where no trap plate is used, the cavity formed in the butt is sealed by gluing in a plug of wood to match. This should not be less than one-half inch in thickness so that it will protect the inside of stock from moisture. When using a trap butt plate, holes may be bored to hold accessories, such as extra firing pins, cleaning rods, pull-through, or several reserve cartridges.

In the design of a butt stock, the top center line from comb to heel and the bottom center line from grip to toe, should be in the same vertical plane. This refers, of course, to the ordinary straight stock. When there is a pistol grip, the thickness is governed by appealing outlines and the shape of the hand, while the comb should be well proportioned with undercuts at the point. For about $1\frac{1}{2}$ inch back, have the comb well rounded. By continuing the shape of the butt plate forward on a taper you will find it possible to carry out graceful lines, with the undercuts ending gently $1\frac{1}{2}$ or 2 inches back of and interior to the tip of comb. A

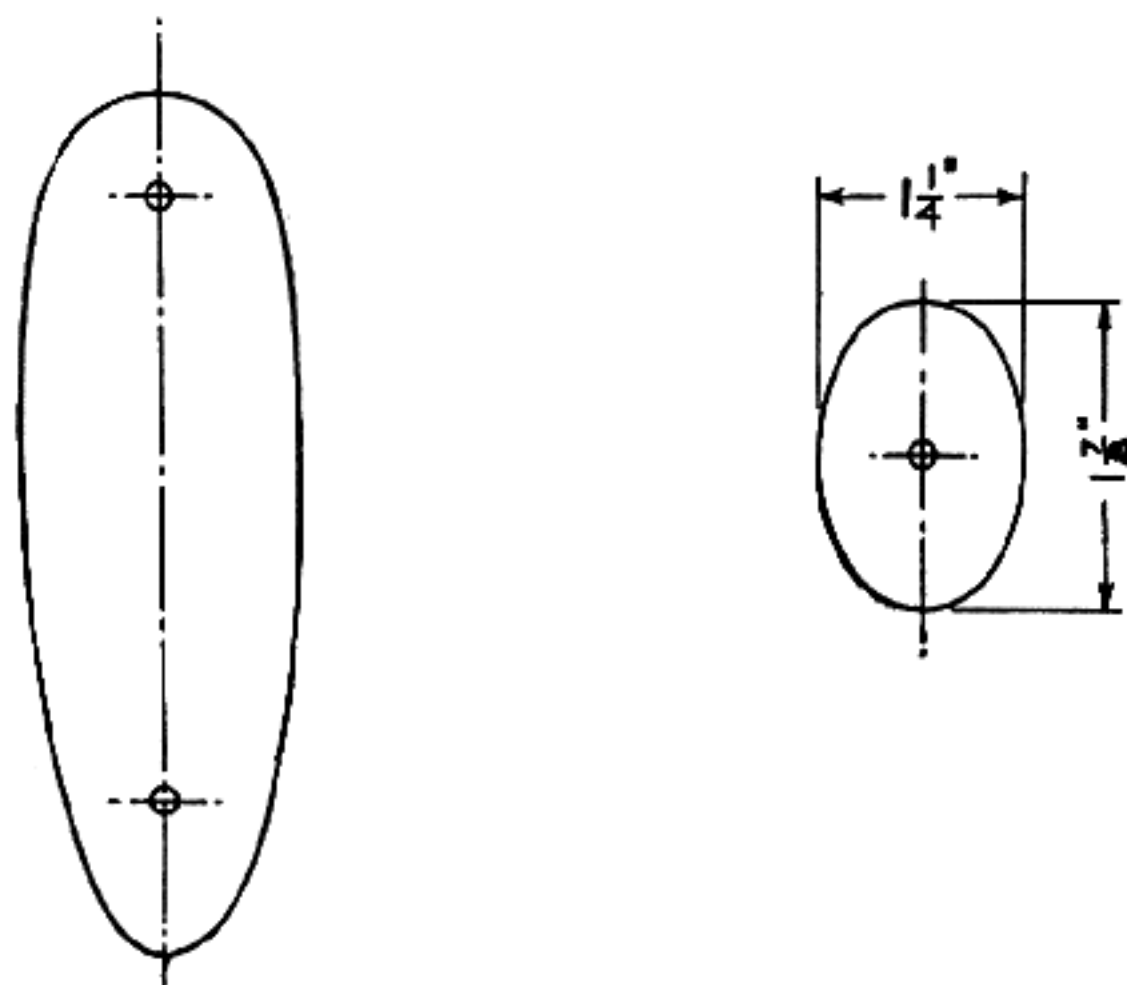

Fig. 68
Butt-plate and pistol-grip templates

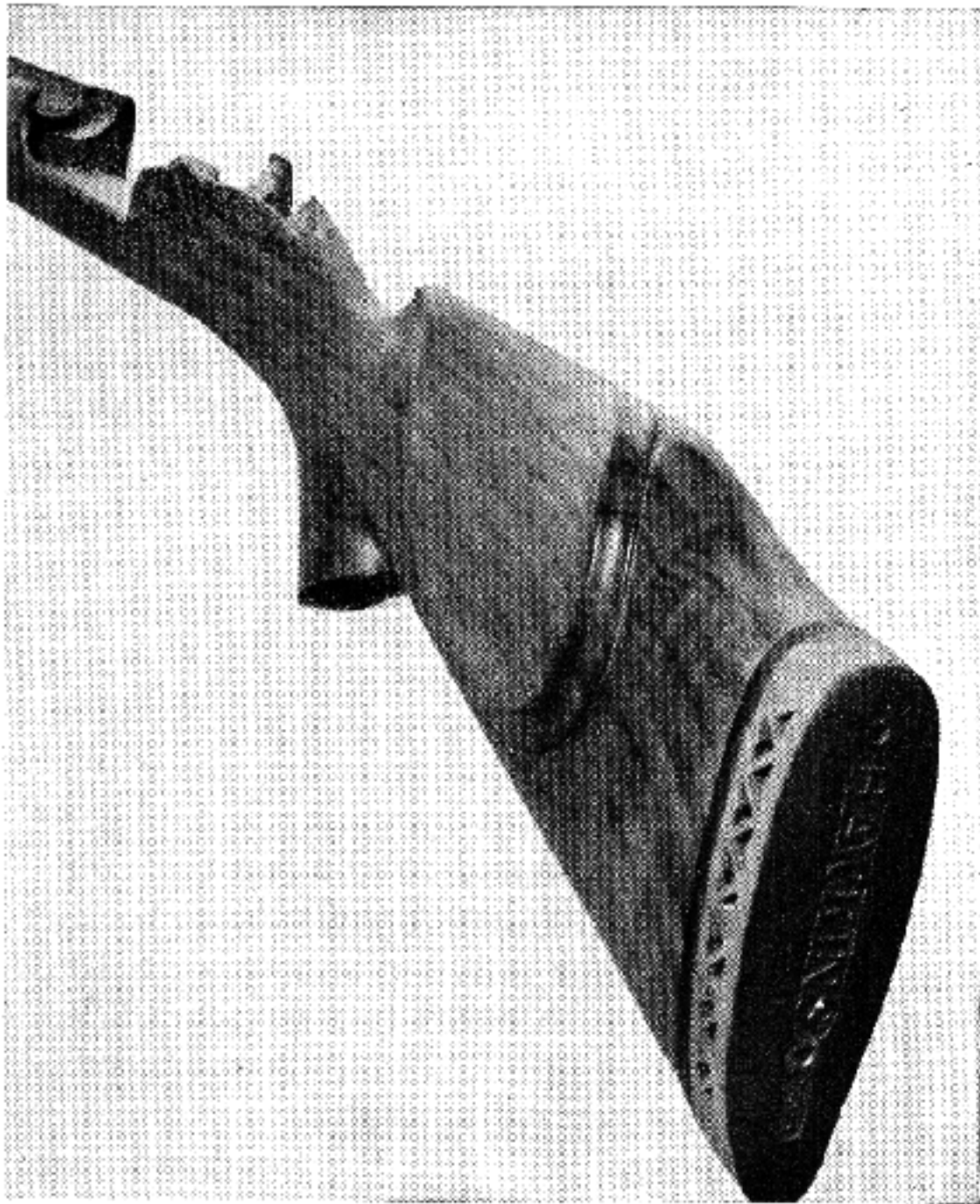

Fig. 69

End view of a Monte Carlo stock, and special cheek piece

neat plain comb, well rounded without undercuts, carried well in from the sides, is also attractive and practical. Figure 77 shows the correct method in which to form the undercuts on a comb. The low undercut from the comb to the hand grip is a great mistake, but one made by a number of beginners. Figure 68 shows a butt-plate templet—and also one for the pistol grip—which is about the ideal form for plate and lap. One-sixteenth inch added width may be allowed for a rather large full butt, but $1\frac{5}{8}$ inch is wide enough when used in a new stock design.

Let me repeat, the line from grip to toe must be straight. A few years back, I had the habit of crowning this very slightly. The center was about $\frac{1}{8}$ inch lower than the toe to the pistol grip. To-

day this curve is deservedly out of place. A slight fulness is permissible on a target rifle or a single-shot stock, but on a well-made rifle or shotgun used for other purposes—never! A shield or crest plate, half-way between the grip and toe, with the owner's initials, looks well. On the best guns these are made of gold, but silver is just as pleasing and satisfactory. Initials, when placed on a gun in a monogram, add a distinctive note and are ornamental as well.

Cheek Pieces—A cheek piece adroitly added to a rifle stock may be beautiful, or if poorly shaped may be ugly; in the latter case it is a source of annoyance, and is as useful as a sore thumb. When designing cheek pieces try to express refinement in every curve, with each one blending gracefully into the other. At the same time, do not lose sight of the fact that such an addition is made for the purpose of acting as a rest for the cheek when aiming and holding. A cheek piece is really essential for a thin-faced person. When it is added for use of a full-faced individual, I deem it in most instances a personal preference and for appearance only.

After having made many different forms of cheek pieces I decided the correct form was the one illustrated in Figure 69. It should add distinction to the rifle and be a help and comfort to the user. Figure 70 illustrates such a cheek piece, giving both lateral and underneath views. The one showing the bead must be carried well out in specified proportions, beginning at the comb and ending at a given distance ahead of the butt plate. You will notice that the lines blend harmoniously and have their point of perspective at the top.

The curvature of the cheek rest should conform to the convexity of the cheek. The rearmost section is high, gradually sloping forward to the comb, so that when recoil takes place, the cheek is perfectly set and no discomfort is felt. The common ones are seen most frequently on cheap popular rifles, as they are easiest to construct.

The Whelen cheek piece was designed at a time

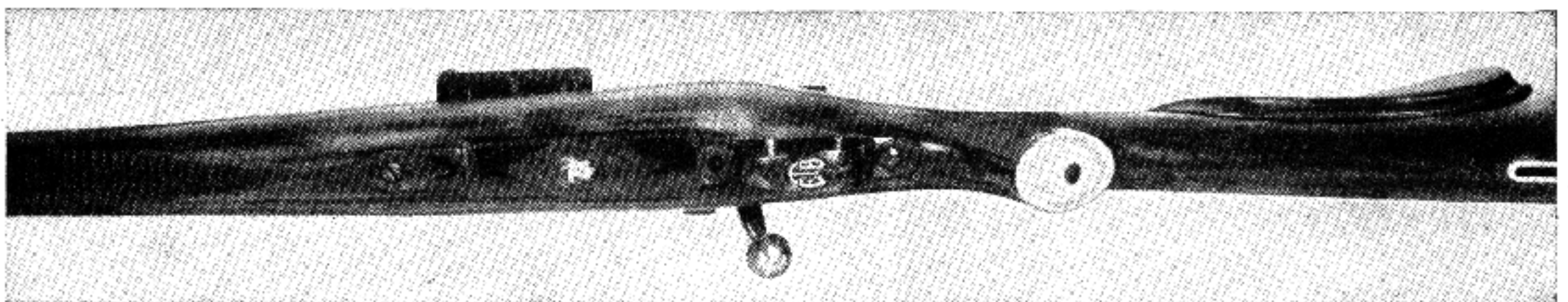

Fig. 70

Under side of a well-formed and graceful cheek piece. Ivory pistol-grip cap, ivory and buffalo-horn inlay near the toe

when the development of rifle stocks called for greater refinement, and the result was a beaded edge which eliminates the unsightly one found on low-priced stocks imported into this country. The Whelen cheek piece, as shown in Figure 84, when carried well to the top, is one of the best.

Figure 66 will give the student an idea of how to lay out a cheek piece. You will note in Figure 69 that the cheek piece does not vary in thickness to the comb or upon edge of stock, nor does it increase as it follows the line down, and it is only when it starts upward on the rear that it becomes full. The concave surface sloping forward permits the cheek to rest in such position as to allow the recoil to divert the pressure from the face. It is like a good saddle when a horse starts bucking, and makes the stock both safe and comfortable to shoot. A cheek piece constructed along these lines aids in the formation of an efficient and artistic comb.

This accessory is a great aid on target rifles, especially those of small bore; however, it should extend further forward to, or almost to, the action, so that it will be possible to assume the position best adapted for that form of holding. Conveniently, it should be high enough so that the sights will readily and without effort fall into perfect alinement. If you are a small-bore enthusiast it might be well to experiment upon a cheek piece of this construction. If you do not care to design at first a new stock with this feature added, insert a cheek piece by cutting into the stock in its central portion, approaching the action, and finally gluing it in place. Your creative ability will be answered by a result fitting your requirements. When you get an understanding of just what you want, it is time to build a stock, using for a model the one you inlayed. Figure 66 will give you an idea of how one of these should look when completed.

Comb Design — Upon the completion of the cheek piece, a comb is the next important feature to be considered. The reader might think this a simple matter of design, but he must take into account the vast number of double shotguns, rifles, and single-shot arms, together with the well-known standard factory output. Comb and stock formation are proceeded with together, beginning at the well-rounded tip of the former, with diverging lines extending backwards to the desired height and thickness of heel. Ideas in dimensions for toe, heel, and grip are as numerous as those of the men and women who have use for guns. I have found that for most requirements a measurement of $2\frac{1}{4}$ to $2\frac{1}{2}$ inches from the end of the receiver to the comb is about the correct distance. On shotgun stocks, there is no fixed dimension, so we must place the

comb tip in the position which adapts itself best to the position of hand and cheek bone, conforming meanwhile to the symmetry of the stock in general.

When designing a new stock for a shotgun, take the measurements from the front trigger. If the model is of the single-trigger variety with trigger in the rear position, deduct about $\frac{1}{2}$ inch to the point of comb. On the Springfield, Krag, and Mauser rifles with single trigger, a measurement of $3\frac{3}{4}$ inches will be about right for the average person. Whenever possible, grip and comb should be fitted to the shooter's hand, keeping in mind the bolt which on its under surface must just clear the comb, and no more. This will give a drop, there, of about $1\frac{7}{8}$ inches.

Most beginners have a poor conception of the proper design of a comb, and this reflects on their ability to make a perfectly designed stock. By carefully studying the figures of combs throughout the book and on stocks that appeal to you, the desired pattern may be found; I know of no better way or more direct line to a satisfactory result. For trial, take any piece of wood and form up a comb as you think it should be. Compare it with the photographs of different arms, remembering to make the undercuts in position. To get it exactly right, you will find, is rather a difficult feat. A comb is a tricky thing to shape, for with this, as well as a cheek piece, the greatest pains must be taken to bring forth the ideal that is admired subjectively and that answers all requirements objectively.

Forearms — The question of forearms and fore-ends is wholly a matter of choice. On double shotguns they should be kept more or less to the well-known standard, except in the beaver-tail model, which is seen exclusively on trap guns. For a shotgun, select a sound strong piece of French, Italian, or Circassian walnut. These woods are tough, hard, and not liable to split. The beauty of the wood is covered often by the checkering and metal parts, and it is therefore necessary to have a wood well marked, if the figure is to stand out over these encroachments. Naturally one can use any strong wood given in the list of woods, but it is necessary to match the wood used in a forearm with that in the butt stock. I have always admired the forearms on the Winchester arms because of their shape, length, and general outline. They look well, feel well, and are to me altogether satisfactory, so I may be forgiven when I think they excel all other commercial arms. The beginner will be wise to use one of these for a guide as to size, length, and form.

Study Figure 71, then measure your hand and

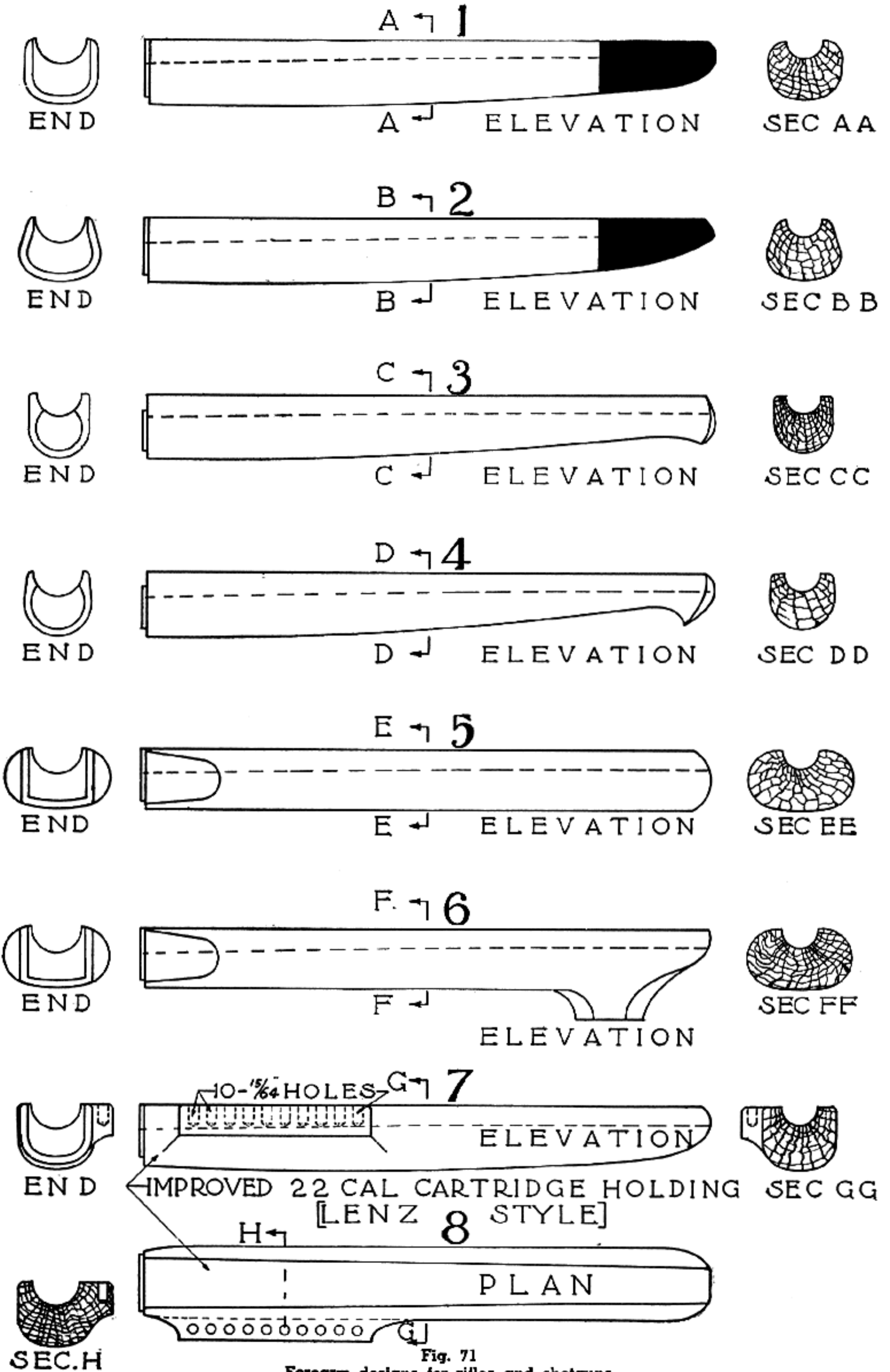

Fig. 71

Forearm designs for rifles and shotguns

study its shape. Decide which type will fit best, "1," "2," "3," or "4." The one designated "2" is universally used on best-made rifles. "1" is a modified pear-shaped forearm, but is really a matter of choice, and is an assistance when one has a tendency toward rocking or canting his rifle. It is not always an easy task to make the lines of this form blend well with the remainder of the wood work, whereas in "2" the lines blend naturally from the sides to the end of the tip. "4" assumes a true cylindrical shape which has its admirers. "5" is the full beaver-tail forearm used so much on trap guns, and lately on target rifles as well.

The general rule to follow—which also helps to bring a rifle into good balance—is to make the forearm on a rifle of a length just about half the distance from the receiver to the end of the barrel, providing the barrel is not more than 26 inches long. Above that length, I practically always use between 10 and 11 inches as a standard length. When placing a swivel base on the barrel ahead of the forearm it should be about 2 inches ahead of the forearm tip, which avoids a cramped or crowded appearance. Attached to the forearm, a distance of 8 or 9 inches from the end of receiver is about right. On a very short barrel with proportionate forearm, it is wisest to place the swivel on the barrel.

The peak of the forearm tip is finished in a number of ways, varying with ideas, likes, and dislikes. Figure 71 illustrates different forms of tips used. A very common method is to shape a "schnabel," so called from the German word for a bird's beak. "3" which pictures a plain, tapered, efficient forearm, adds a mark of distinction to any well-designed stock when formed gracefully. An improperly designed schnabel is always an eyesore, and so unattractive that it never fails to bring forth derogatory remarks. This, like the comb, reflects your taste and calls for practise with an easily-worked block of wood in order to secure the sought-after form and graceful lines. Make up a number of sample pieces so that you may express your ideas and compare them. Simultaneously, study those on factory arms, which, because they have been made by machinery, have a simple design and will be easier of construction. These patterns reproduced by hand can be further improved by any number of artistic curves. "2" in Figure 71 is the plain, common tip. It is not attractive to a well-designed stock because the under sides slope too abruptly toward the barrel. "1" is the British style of forearm tip made with buffalo horn, bakelite, ivory, and various other substances, including the forearm wood itself. If you are designing a fine rifle, Asiatic buffalo horn is the proper material

to use, for it adds not only refinement but beauty and worth. You may file any shape you desire, but the plain British method is far superior to any other.

Design of Sides — Shaping the sides, from the end of the magazine and action, must be done with a sense of proportion, and this is an important consideration in the construction of all stocks. Starting at a point from the grip to where it begins to broaden out, it should be well rounded from the action to the guard and magazine. There are no set rules to follow, except to carry the lines well into the forearm and grip. Do not make the sides too thin, or too thick either, for neither answers the appeal of satisfactory outline. From a point half-way from the end of the receiver at the trigger guard back to the beginning of the pistol grip, each curve must be fully carried out, blending into the sides and pistol grip proper. When stocking a large caliber magazine rifle, the same rules particularly apply; and do not think that because it is of heavy caliber you must increase the thickness. Also, never cut out for the magazine cut-off on a Springfield rifle. Allow only for the cut-off to come down to a point where it is possible to remove the bolt; a cut-out at this point only spoils the appearance and is quite unnecessary. Some may wish to use the Springfield as a single-shot with a magazine full of ammunition, but while this is all very well in warfare, there is no need for it in a sporting arm. It is just as well not to cut out on the right-hand side of a stock, at the loading gate, any lower than the upper edge of the receiver; and when rounding this edge, do not carry the curve any lower than half the radius of the wood thickness. When fitting a Lyman 48 sight, always allow $\frac{1}{32}$ -inch play between the slide and the stock, for when cutting out a recess for the slide under these circumstances, the stock at this point will assume a clumsy appearance. This sight requirement will be a guide to the thickness of the wood on both sides. Methods will be described later to cut off the sight base and slide, without cutting out any wood.

You will notice there are panels cut on some foreign-made arms, which extend out from the sides in different forms. This is perfectly correct for parlor furniture, but on a well-designed stock it seems ridiculous in the extreme to attempt to make hand work compete with a beautiful wood design. That part of a stock should, I think, be perfectly plain, relying on harmonious lines and handsome wood for its beauty.

Grips, Hand and Pistol — The finished design of a pistol grip on a rifle depends naturally upon

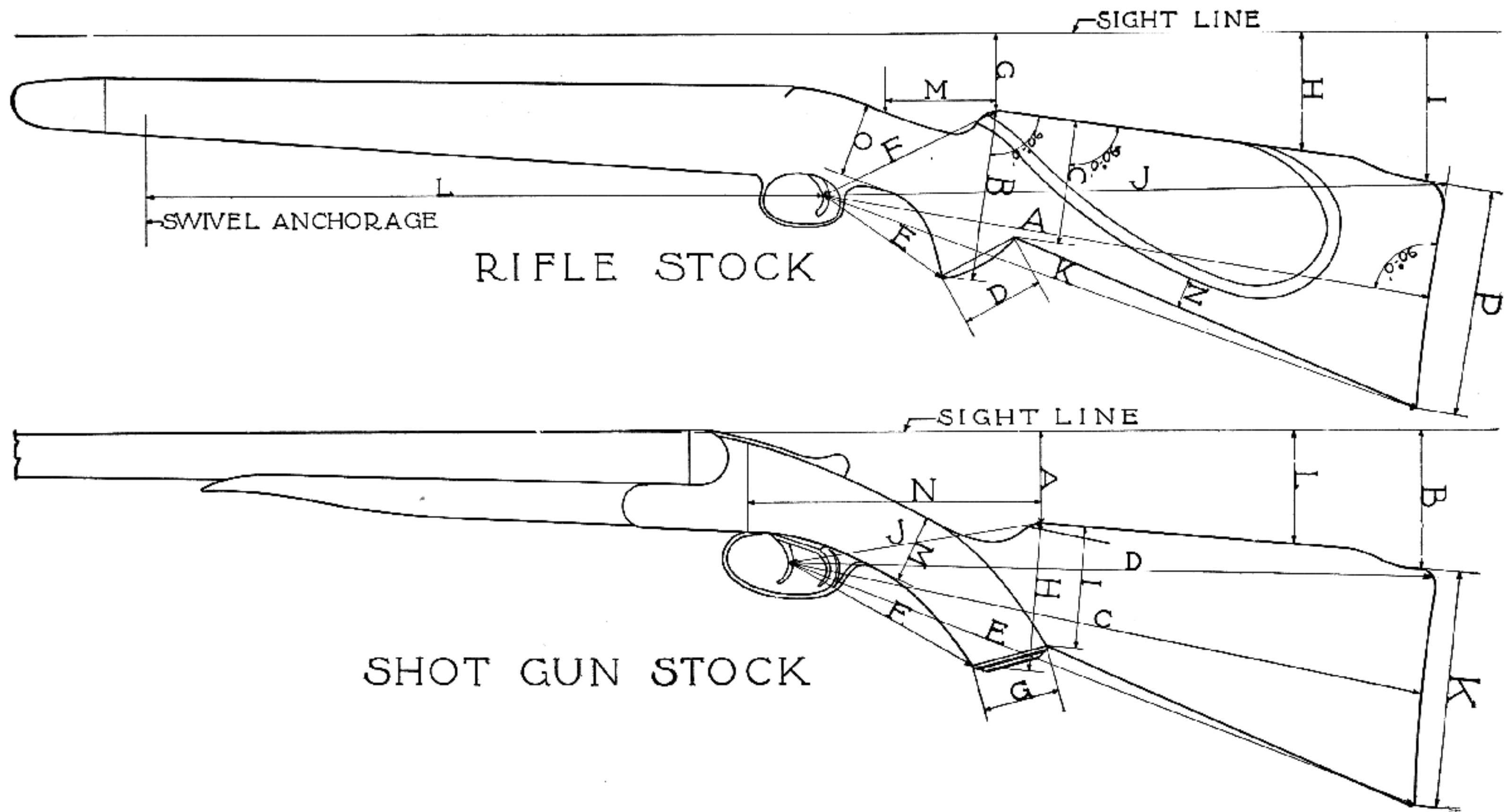

Fig. 72
Rifle and shotgun stock designs

how it was laid out to begin with. If the reader will follow Figure 66 he will have no trouble. Pattern and dimensions are important, but if you follow them there is no reason why you should not be rewarded by pleasing lines. Pistol grips on rifles vary, of course, with the form and size of the user's hand. On military arms they first appeared in connection with the German army rifle. The British also evolved a grip which looked like a stock upside down, but you would be greatly surprized, on handling it, to see how much better it is than it looks with its slight offset in the stock at the hand hold. We, on this side, were very quick to see the merits of this addition, even tho it was so inadequate and placed so far back that it did not really answer the purpose intended. To Colonel Whelen and Adolf Wandhammer must go the credit for the improved design of pistol grip. When Colonel Whelen and I first experimented with pistol grips, we placed them at once closer to the trigger, at the same time constructing them so that they snuggled the hand in the most advantageous position, obtaining thereby much steadier holding. The proper development of a pistol grip on military rifles has only been attained in the past fifteen years, and there is still plenty of room for improvement.

Figure 72 will give you an idea of how to obtain prescribed measurements of a pistol grip of a given pattern. A number of common mistakes will be made by the beginner, as in *D*, *E*, and *C*. The correct distance from center of trigger to edge of grip cap should be between $3\frac{1}{8}$ to $3\frac{1}{2}$ inches, and when this is accurately determined the other measurements naturally fall in line.

The circumference of the grip is, in a measure, governed by the size of the hand. When we speak of the circumference of pistol grip, we talk only in terms of a duplicate measurement taken from the stock which was made to suit a particular individual, and no specified size can be given for one who has never had a grip made to fit his hand. When one is making a new stock, subject the grip to repeated trials or until the hand can take a comfortable hold around the curve. You can form up a swell on the right side if you wish. It is permissible but not essential. A well-shaped grip is one which will measure $1\frac{1}{4}$ x $1\frac{7}{8}$ inches and blend into the other lines of the stock. Never make a pistol grip on the full circle as some are made; this is a mistake of which many beginners are guilty.

The most graceful grip is one which blends in well with the bottom lines of the stock when looking at the stock from the side, with a continuous, harmonious line from the forearm to the toe. Another mistake is to have the pistol grip together with the

cap extend down $\frac{1}{4}$ inch or more; it should be even with the bottom side. It is of vital importance to have the pistol-grip center directly under the comb. In forming up to the rear of the grip do not carry the outline to the comb; rather allow the form of the grip to merge into the stock a short distance to the rear of the grip cap.

The most preferable design for a pistol grip cannot usually be secured from factory stocks, as in most instances they are hurriedly made, with cheapness the most-sought-after quality. Attached to the Springfield sport-model stock is the only real grip, so placed and of such volume that it permits the changes necessary for its transformation into a satisfactory design.

I am obsessed with the idea that a pistol grip has no place on a fine shotgun, that it adds a degree of clumsiness and detracts from the otherwise sleek and racy lines. Notice the straight-hand grips on the best British doubles; also the Over and Unders, by Purdey, Beesley, Westley Richards, Woodward, Boss, and Powell. All these arms handle without effort and are noticeably smoother in action and more mobile than those fitted with pistol-grip stocks could ever hope to be. A grip on a shotgun stock should be constructed with every degree of forethought, having in mind such details as a perfect fit to the hand, correct length, distance from trigger guard, and small oval cap preferably of polished buffalo horn. On our American shotguns you will find grip caps of hard rubber with the maker's name around the edge, constituting not a very esthetic method for either advertising or embellishment, and, to say the least, a poor substitute for horn. A much neater cap can be made from a host of materials which would add greater beauty and efficiency than the present double-purpose ones furnish.

Single-Shot Action Stocks — These, you might say, are similar in design to shotgun stocks, but great liberties are taken and the variance is considerable and unending. In the case of the Swiss single-shot rifles, the makers have added everything possible for the comfort of the shooter, and more. This is likewise true of many of the beautiful American single-shot Schuetzens made during the past forty years. Today, American manufacturers do not have much demand for such arms, except by resale, and they are unprocurable. Take the famous Ballard or the Maynard (the latter made by the Massachusetts Tool Company fifty years ago), and the Stevens and Winchester. Some of the best stocking ever perfected in America was done on these arms.

Stocks on single-shot actions should, in the main,

follow the general outlines featuring other rifle stocks. It is interesting to formulate specific ideas which may be of benefit to users of single-shot rifles, such as modifying the upper and lower tang, and to place a pistol grip as often shown on one of the old single-shot Winchesters.

The Farquharson falling-block single-shot action has the tang and under-tang well shaped for a pistol grip. I have had several of these actions made for me in England, and am using them in connection with the .22-caliber Hornet cartridge. It makes one of the finest single actions for the cartridge, and when, in addition, the barrel is made by Vickers, Westley Richards, Niedner, etc., you have an extremely accurate combination.

A beaver-tail forearm is preferred by many on single-shot target rifles, but it is naturally out of balance and clumsy in appearance. Still, it adds to the ease of a steady hold, because it is flat on the bottom and very full on the sides. Further, it permits a natural position to rest the forearm, either in target or trap shooting, in the palm of the hand. Some of these beaver-tail forearms are made wider at the end than at the action; others have a gradual taper to the end, while still others have a very pronounced taper. Some are made full in the center, where the hand grips when in a normal position. I believe this last form the most attractive and useful.

Stocks placed on rifles such as models 86, 94, 95, 12, 97, and various other Winchester rifles, can be restocked to better form, also those of the Remington and Savage makes. Most of the small .22-caliber rifles in repeating models can be improved. I am of the opinion that Marlin has made the best stock in the .22 caliber, but the idea can be altered to advantage when constructing a new one. The standard forearms on all of these rifles are good, and it is difficult to improve their design. One would imagine, however, that all our American gunmakers labor under the belief that .22 rifles are to be used only by children, so diminutive is their size.

Shotgun Stock Design—A book might be written on this topic alone because of the multiplicity of opinions on just what the ideal stock is in shape, length, drop at comb, heel, and various other qualities. I have mentioned throughout this chapter different ideas of design. The shotgun stock may be taken as a standard of measurements, including such elastic points as cast-off and cast-on, balance, drop, comb, and pistol grip. There is one type which I have so far not mentioned, and that is the "Monte Carlo" effect. Its consideration may well be taken up here, since many of the ideas of

change from the ordinary, originated in the evolution of that style of stock. When I make a new stock for a customer, after knowing the correct drop at heel, I leave the high line of the comb up $1\frac{1}{2}$ to 2 inches from the butt plate, and drop it at that point $1\frac{3}{4}$ inches for shotguns and $2\frac{3}{8}$ inches for rifles. In the final setting, I begin to cut this down until I arrive at the correct drop of comb. Some will require rather a high two-thirds distance measurement, which is at the top of the high point from the comb.

It is surprising what this signifies in either a rifle or shotgun stock. I believe it is the only satisfactory method for correct measurement of any stock. I have found that with a drop at heel between 3 and $3\frac{1}{8}$ inches, the height at point of comb should be $1\frac{1}{2}$ inches, and at two-thirds distance 2 inches, and midway about $1\frac{3}{4}$ inches. These measurements are for double shotguns. For bolt-action rifles such as the Springfield or Mauser with the offset, I prefer measurements of between 3 and $3\frac{1}{4}$ inches at heel; at comb $1\frac{7}{8}$ inches, which is bolt clearance, and at two-thirds distance between $2\frac{1}{4}$ and $2\frac{3}{8}$ inches, midway between about 2 inches. Forming the step is a matter of choice, but modified step-off is the best when the lines blend well down to the top of the butt plate. The contour of the step-off is a delicate matter and never fails to be the cause of complaint when it does not accord with the owner's sense of beauty.

A comb must be placed in such position, especially on a shotgun, that it will be possible to handle the gun not only accurately but rapidly. A comb too far forward would be a bad feature, for it would be in the way of the thumb. A shotgun stock should be fitted so perfectly that the same hold will repeat itself consistently. Weight distribution governs shotgun manipulation as well as a correctly fitted stock, and must be considered seriously with the latter to bring about perfect coordination. Excellent practise for one who has never stocked a shotgun is to begin with a piece of soft wood, which should be first adjusted to the action and then formed up until a perfect fit is accomplished. The beginner will then, in a measure, have confidence and knowledge to proceed with a stock of given measurements as taken from the completed sample stock. In the soft wood you have chosen for a pattern, it is a simple matter to fit the metal parts, as you will not have to cut out except for the action and tang, together with the trigger plate. Next begin to form up the outside, not necessarily to fit any butt plate, for all you require is the length, drop, pitch, and cast-off, incorporating the ideas which I hope this chapter has imparted to you.

After securing all the measurements, jot them down on paper with a sketch showing the particular things you have done so that nothing will be forgotten, as a check on the second stock. If your gun has but a single trigger, a pistol grip is more easily installed than where you have to deal with two. I am sure that on a fine shotgun, however, the straight grip is to be preferred. Except in an army shooting school, it is definitely impossible to train shooters in general to assume the proper shooting stance, so we must continue to build stocks to suit their peculiar methods of holding. Often they figure that it is much cheaper to build a new stock than to change their habits. Such a change is one of the hardest things to bring about, for most men rebel against being told what is right or wrong, even tho they realize later that it is to their advantage.

A cheek piece placed on a shotgun stock, you must know, is not productive of special benefit unless you have a thin or narrow face. Its outline and symmetry must harmonize with the rest of the stock, else it will be an odious attraction. With many it is merely a matter of choice, and as part of the shotgun ensemble it is comparatively rare. The heavier such a gun, the heavier and fuller the stock should be at the comb, which obviates the necessity of a cheek rest; its presence then would act only as a detraction in speed of handling. The comb made with a comfortable thickness helps against recoil, and encourages more accurate aim, providing the proper cast-off is given to the stock together with the correct pitch.

On occasion we encounter stocks with identical measurements at comb and heel. These dimensions are abnormal and may be changed, often with definite advantage to the Monte Carlo comb shown in Figure 69.

There are so many conflicting ideas in shotgun stocks, both for field and for trap use, that the only natural procedure for the novice is to have a stock fitted correctly in the first place by a craftsman who has skill and experience; for then, and only then, will he appreciate what it really means to shoot a gun with comfort, accuracy, and confidence.

Abnormally Formed Stocks — In the event of a shooter losing the sight of the right eye from mishap or defective vision, no better encouragement can be given than to recommend the side rib shown in Figure 73, a monocular gun which is used by a man who lost the sight of his right eye. The same effect can be obtained with a gun modeled as if the stock had been bent over or so fashioned. The illustration gives an accurate idea

of a principle which is the idea of Mr. Frank Hogan, and his work at the traps testifies to its suitability for the purpose for which it was made. The disadvantage of having a stock with a cast-off as much as $3\frac{1}{2}$ inches is that in firing the left barrel it shoots to the left; in addition the gun would handle clumsily to any one used to the orthodox stock. A single gun would not appear nearly as clumsy in this respect as a double.

Mr. Hogan's idea consists of a master piece of flat steel running from the muzzle back a distance about 20 inches with two ivory bead sights attached. This rib is fastened to the left side of the barrels by two brackets; one at the muzzle and the other about 18 inches back from it. The sights on this rib are set over $2\frac{1}{3}$ inches at the rear and $2\frac{1}{2}$ inches at the muzzle. He has broken 98/100 clay birds with this style of gun, and on another occasion has run 147 straight. It proves that any one who has a similar disability may benefit by this addition rather than by a bent stock. For the latter it would be necessary to have the stock made of walnut with the grain curving in the bend; the tang of the action would have to be bent, also, together with the trigger guard; consequently it is advisable and much cheaper to make a rib, as shown according to Mr. Hogan's idea.

A try-gun is an odd arm to the average person, but one which is used a great deal in England to fit gun stocks. It is possible to secure length, drop, cast-off, and pitch with this contrivance. There are comparatively few of them in the United States, as only a limited number of gunsmiths understand the proper methods for fitting even the normal person. I have had two recent examples of this. One man was fitted erroneously with a 15-inch stock when he should have had a $13\frac{1}{2}$ inch, and another a $13\frac{1}{8}$ -inch length instead of $14\frac{1}{4}$, while the drop on both stocks was out of all reason. Correction in both instances ended in a most gratifying result. Should you be so fortunate as to be measured with a try-gun by one who knows how, cherish the figures sacredly and check up on your every finished stock. The British gunmakers are exact in their measurements. Practically all try-guns are made in England, and every maker who conducts a more or less extensive business in fitted stocks should have one. The expense, increased by a generous duty, is a drawback to their extensive use in this country.

I have eliminated as far as possible all numerical measurements on stock design, and use figures only where it is necessary to illustrate a specific model. Most measurements will be given in the following chapter. They vary greatly, and it will be my

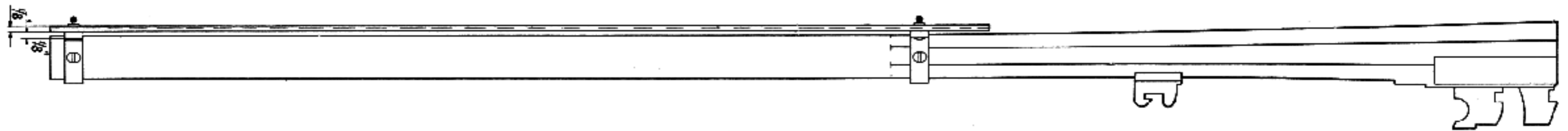

ELEVATION

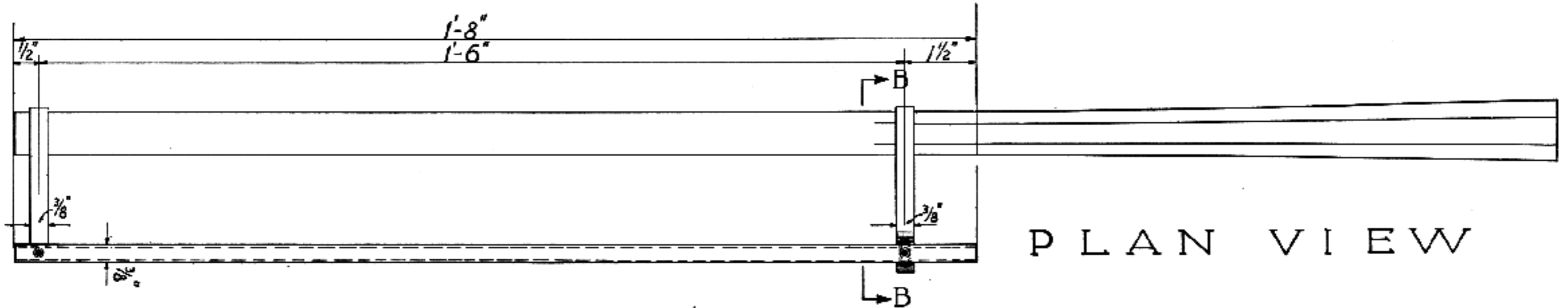

PLAN VIEW

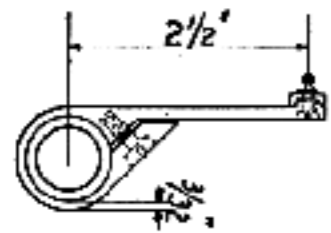

MUZZLE VIEW
MACHINE STEEL
BLUED FINISH

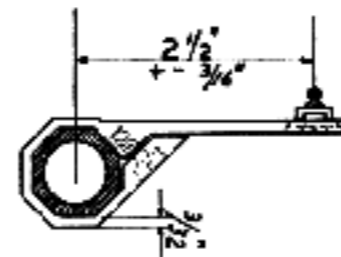

SECTION BB
MACHINE STEEL
BLUED FINISH

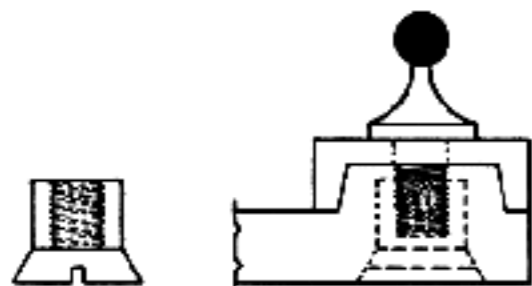

HOLLOW ENLARGED
SCREW VIEW OF
MUZZLE
SIGHT

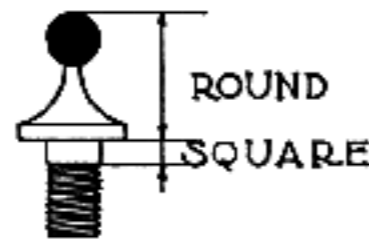

SIGHT PIN

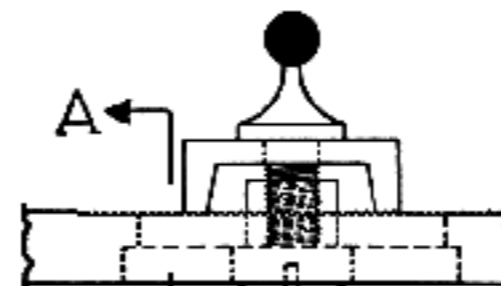

ENLARGED
VIEW OF
REAR
SIGHT



SECTION AA

Fig. 73
Offset rib used for monocular vision

endeavor to apply myself to the necessary and established ones. Figures are not indispensable to stocking a gun except in the length, drop, cast-off or cast-on, pitch, length of forearm, distance from trigger to edge of pistol-grip cap, and balance. All other dimensions and contours are attained with the aid of the eye, which is our principal guide—that and our creative ability. This, largely, is a sense which is congenital when at all present, and finds its expression in a love for beauty which prescribes and directs the work our hands are eager to perform.

Satisfactory achievement in any worthwhile venture naturally takes time, but in the end, if you are persistent and loyal to your desires, your efforts will be rewarded. Sad to relate, we have among us men who regard the gun only as a tool to slay, and more than likely stow it away, possibly without cleaning, after the hunting season, until the next one follows. The serious gun crank resents this type, for he is usually disinterested in the scientific aspects of the game and lacking in creative ability, without which it would have been impossible to bring about the present high state of beauty and remarkable effectiveness in every modern firearm.

The work outlined in this arduous chapter will not be found easy always, but I can assure you that it is intensely interesting and worthy of your every effort. My earnest advice is to proceed slowly in all your undertakings, curb impatience, and do not expect immediate perfection. The slower worker will save much time by avoiding mistakes, and this time can be devoted to productive thought for better ideas as the work proceeds.

Final work on stock and forearm consists of checkering to obtain resistant surfaces which enable the user to handle the arm with assurance, and fortunately on the finished product it forms an attractive decoration. Actually, it is not essential, but when masterfully completed it is an unfailing mark of distinction that identifies the higher type of guns.

Probably many will disagree with me relative to my choice in design of stocks; however, I am certain that under no circumstances could I have done better than to take for models the superb products of British gunmakers. My efforts have been untiring to combine simplicity and practicability with the British ideals, so that they will be within reach of the American sportsman and not beyond the accomplishments of the amateur.

CHAPTER IX

Laying Out the Stock—Inletting the Action

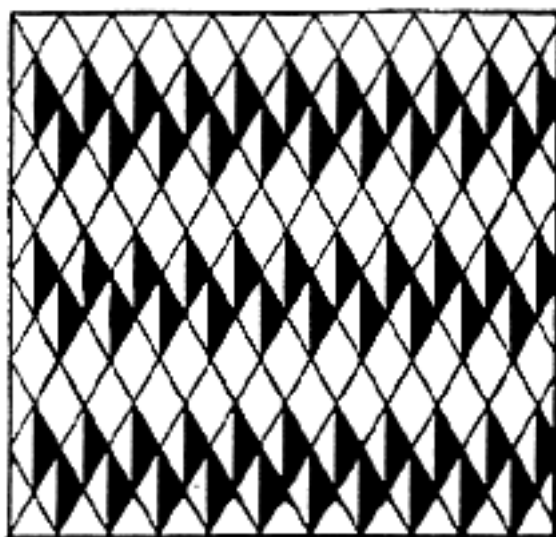

Laying Out the Stock—Inletting the Action

THE outstanding ambition of every amateur gun enthusiast is to make a stock, and it is my earnest endeavor to describe this operation as completely as possible, so that the reader will be carried step by step through each fascinating detail in the process. With long experience as a guide, I realize the many difficulties which are bound to be encountered; but if patience, accuracy and forethought are practised, these should not be insurmountable. In this work, more, almost, than in any other, forethought must be used and each move carefully planned before being executed if satisfaction and success are to follow.

The general principle of inletting is the same for all guns, differing only in the form of cut coincidental with the varied contours and actions.

Select a suitable blank from the list of woods described in Chapter VII (Selection of Woods). Have in mind clearly the desired stock design, which is to be completed according to prearranged scale, dimension and finish, not losing sight of the required thickness of wood at points corresponding to butt plate, center of stock and action. If a cheek piece is planned, select a blank $2\frac{1}{4}$ to $2\frac{1}{2}$ inches in width, which is necessary to include the limits of its outline. An essential measurement is across the end of the blank where the action is

placed, which should be at this point two inches for a straight stock without a cheek piece. Drop, cast-off and length of butt plate are additional essentials demanding constant care in the provision of sufficient wood in the shaping process. Lay out the blank for measurement as given in Chapter VIII, illustrated by Figure 72. These measurements may be accepted as generally correct. It will be of material service to cut out a pattern, laying the top edge flush with that of the blank. With a pencil, trace identical lines on the rough blank, allowing sufficient wood to finish with, not forgetting length. Figure 61 applies to a stereotyped pattern applicable to shotgun and rifle stocks. When using the shotgun pattern it is most important to follow the method described for laying out of blank, including use of pattern, since at their surface of approximation all shotgun actions are not on the same angle. An adjusting block, so called, will take care of most angles at the back of the action; but for the sake of certainty reference to the accompanying instructions should be made constantly.

The Springfield is the most popular bolt-action rifle at this period, and I shall begin with a descriptive method for inletting. Whatever finish for the metal is intended should first be completed,

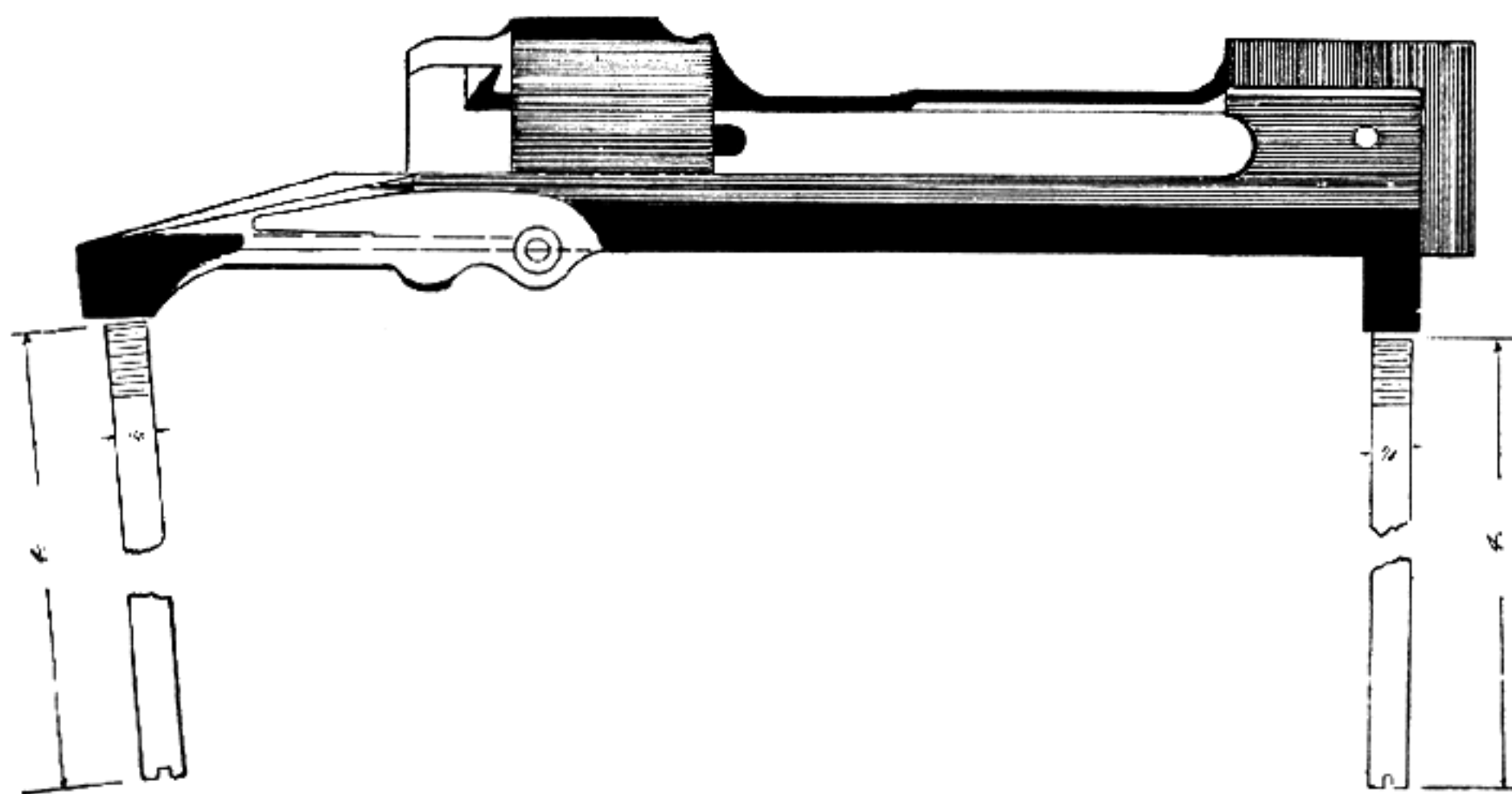

Fig. 74
Springfield receiver with locating screws in position

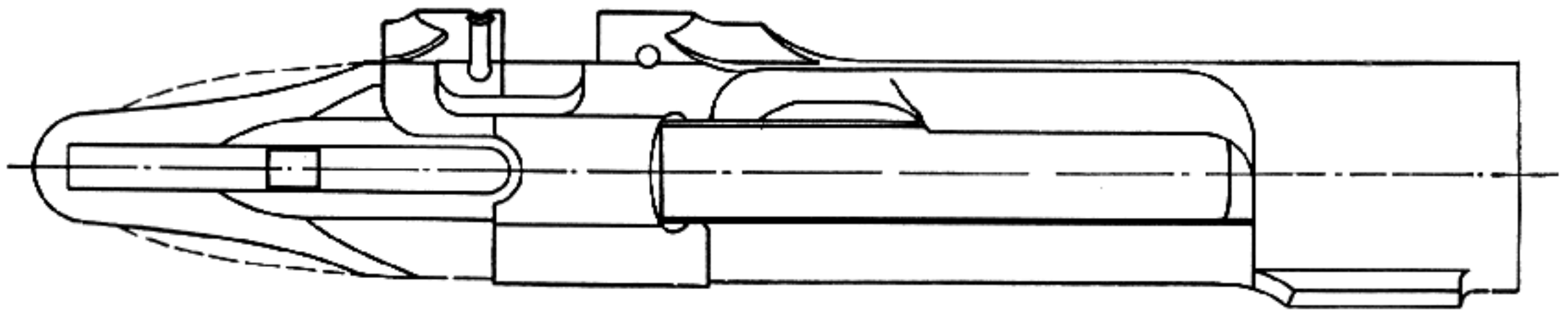

Fig. 75

How a Springfield receiver is ground at tang for more graceful outlines when restocking

in the sense of receiving its last operation in polishing. Leave barrels, ramps, sight bases, swivel bases, etc., in the white, but polish for fitting into the blank. Make two long screws as shown in Figure 74, and grind out the tang of the receiver as shown in Figure 75. Grind a $\frac{1}{32}$ -inch radius on the end of the receiver next to the barrel. To study the cuts in an old service stock would be invaluable for proper location of guard, barrel, etc. Study the action in Figure 74 to gain the correct knowledge of such important points as the recoil shoulder, tang of the receiver, trigger guard, flat under-surface of the recoil shoulder, rear-guard screw bushing, taper of barrel, cut-off, projection, sear, and trigger, the radius formed on the magazine, also at the end of the tang of the receiver, front and rear of guard, and the projection on the right side of the receiver near the barrel. There are various concave and convex sections and cut-outs to be considered also.

When inletting any action, you are working reversely, for the solid portion representing the action, etc., is cut out and the openings remain. Notice on the old stock that there are places showing machine operations. These were executed in a few moments by a fast-revolving cutter, but the same operation will take hours of painstaking labor to accomplish by hand; however, the result should and very likely will be of a higher quality in every way.

Before proceeding to lay out primary lines on the rough blank, study Figures 71 and 72. As an initial step, square the top with both sides and lay out lines such as shown by lines in the drawing, allowing enough margin for finishing. Having the top and side surfaces planed square, scribe a line in the center of the blank from the tip to the butt, continuing to and including ends and under side. With a die-maker's square check this line from one side only, and continue laying out the work from it. The measurements for drop are taken from this side only, in order to preserve an exact center. Now place the magazine and receiver, together with the trigger assemble, against the side of the stock in its required position, allow-

ing enough over all to finish the butt. The amount is determined according to instructions given in the chapter on design of stocks. After the receiver and magazine are in place, mark the tang of the receiver and the end of the trigger-guard on the flat side of the blank. Transfer these lines to the top and bottom of the blank with a try-square; they are the lines you will work with. Take all measurements of the guard forward; measure the distance from the end of the trigger guard to the magazine, marking at right angles with a line, and measure the length of the magazine and draw another line in the same manner. Having these two lines for length, with the aid of a divider lay out the width of the front and rear portions of the magazine, from the center line, connecting these two and mapping in this manner the site of the first cut-out for the magazine.

Figure 76 gives correct dimensions of the bottom side of Springfield guard. With a $\frac{1}{2}$ -inch auger bit remove this center, having first outlined it with a divider. Do not encroach on any line nearer than $\frac{1}{8}$ -inch for the reason of the tapering of the magazine from the bottom to the top. Center-punch the centers of the divider marks, and bore this out, removing the center by cutting out the thin webs with a broad flat chisel. At this stage proceed slowly, removing wood as far as the tracings show you may go, until the magazine enters snugly. Aside from the openings made with brace and bit, the entire operation is accomplished with different-sized chisels. The broad flat ones are used for the sides, the narrow ones for the ends, and the round gouges for the radii in the corners.

After the magazine begins to enter, mix a small amount of lampblack with sperm oil, and make a swab tied to the end of a small piece of wood, the end formed as a handle. With this apply a thin coating on the sides of the magazine in order to mark definitely the tight places. Gradually remove these until the magazine enters freely and evenly, showing a bearing all around where the metal touches the wood. As the magazine is entering, have a try-square at hand and place it on the bottom of the former, testing against the side of the

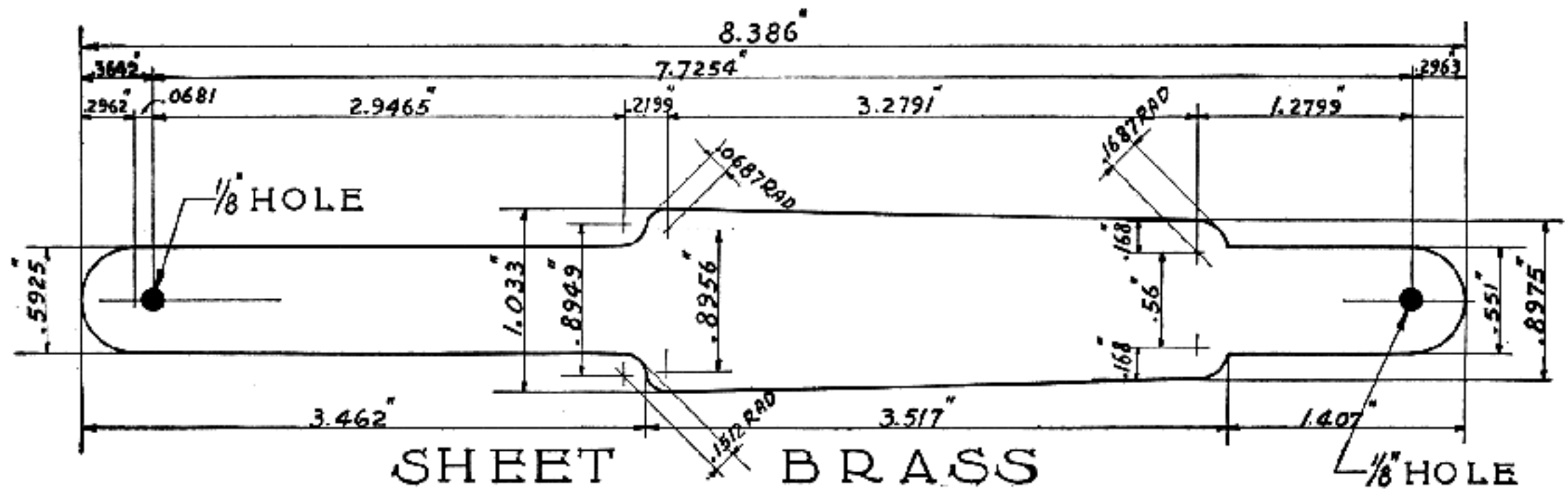

Fig. 76

Springfield guard templet for laying out purposes

blank from where the lines were taken. By this method the magazine is kept from entering the blank at an angle.

The projection on the front tang of the guard prevents complete introduction into the wood. Use lampblack on the face of this and with a small mallet lightly tap the top so that there will be made a good impression. Use the dividers to locate the center, and with a 1/2-inch bit bore in 1/2 inch; the bit is the exact size of the projection. Continue down with the guard. Notice that the guard is plainly narrower in its front portion than in the rear, and that the trigger guard slopes gradually downward from this point. Keep the top of the magazine parallel with the top of the blank, permitting the under side to come as it may, since allowance was made for this when the under side of the blank was cut out. Continue to fit in the magazine until the impression of the rear and front tang shows. Now proceed to enter these in the blank. You will notice on the front tang that there is very little support left between the projection and the end, so care must be taken to get a perfect fit on the radius. In proceeding downward, notice that the projection contacts with the bottom of the 1/2-inch bored hole. Relieve this just a little, continuing until the guard is in place, so that there will be a bearing at this point. If made too deep, most of the center support of the recoil shoulder will be removed, leaving only the sides for a bearing, in which case it will be necessary to fit in a steel block to restore adequate support to the shoulder. Since this is the most important point in recoil uptake, its bearing between metal and wood must be rigid.

When letting in the guard, allow 3/16-inch clearance for the receiver. Going back to the trigger guard, it will be noticed that the floor-plate catch, in order to operate freely, is in a cut-out near the magazine; therefore mortise for this upon completion of the inletting. Do this before inletting

the guard. You will again notice a slight angle on the radius at the end of the tang, on the guard, which is tapered to the bottom. Make these cuts on a wedge effect, which assures more perfect fit when the tang is finally let into the wood.

With the guard in place, bore completely through the front guard-screw hole with a hand drill, 1/4-inch diameter, using the hole in the guard as a guide. When drilling, keep the drill at right angles at all times. Remove the guard from the stock and replace it after enlarging the hole to 3/32 inch. Connect the long screw, making it possible by first attaching to the receiver to lay out the latter on top of the blank. With a die-maker's square, check the center of the rear end of the trigger guard for any deviation from center line. Should any have occurred, allow for it on the tang of the receiver, establish a new center line and make the center of the tang of the receiver continuous with it.

On the rear of the magazine is an extension which projects up in the receiver magazine cut. The magazine and receiver must fit as intended. If a straight edge is placed on the inside of the magazine at the rear, there should be revealed metal of the thickness of the above-mentioned projection, which, according to scale, projects into the magazine opening approximately 1/8 inch. The eye will tell and is the only guiding agent to determine whether or not the extension can enter the receiver in the right position. Done in this manner, it will be a check on whether receiver and magazine are being brought up together properly. The tendency is to place the receiver too far forward.

With a try-square, draw a line across the blank at the recoil shoulder and end of tang. Remove the receiver, measure the width of under side, and with dividers lay this measurement on the blank, scribing the lines the full length of the receiver. For a check, scribe a line across the blank at the end of the receiver where the barrel screws in.

Work can be greatly facilitated by first breaking the barrel out from the receiver, using for this a barrel vise as shown in Figure 87, Volume II. It is possible to fit the barrel and receiver together, but to simplify the operation, the receiver should be fitted separately. Assuming that the beginner has no barrel vise and must fit the barrel and action together, I shall carry out my instructions accordingly.

When starting the action in the blank, the fit around the rear tang of the receiver should be close and the recoil shoulder show a solid and even bearing. The under surface of the receiver between the recoil shoulder and the end of the magazine should always bear evenly and parallel against the wood; likewise from the rear part of the receiver to the receiver tang. The cut-outs in the wood must correspond with the contour of the metal.

When first letting the action into the wood, use a light coat of lampblack on all contacting metal surfaces, and be very particular not to remove too much wood at each cutting, which is often encouraged by applying too much lampblack to the metal. Only a very thin, light coat is necessary to give the desired impression. A flat chisel, about $\frac{1}{4}$ inch to $\frac{3}{8}$ inch, is used mostly; also pattern-maker's gouges for inletting the barrel, the width being between $\frac{1}{2}$ and $\frac{5}{8}$ inch with a gouge for the rear tang.

Before penetrating very far with the receiver, the barrel letting-in process should also be started; and when let in the wood, half-way to the short taper, draw a pencil mark along the sides, keeping it well in the center. The tang of the receiver is also down in the wood by this time, therefore hold a bearing on the flat under surface at the screw hole.

Check up between the rear of magazine and receiver to see if they are coming into correct position; also check with your eye to see that all parts are going in at right angles. This may be done by using a 12-inch combination square, laying it on the inside of the bolt-slide channel of the receiver opening. With the square in position, the eye sighting along the blade detects the slightest variation which may have crept in. When approaching the rounded sides for the action, there will be a tendency to work too far to the left; guard against this. The trough for the barrel has at this stage begun to take form in the wood. With a scribe, draw a line the full length on both sides, well in against the barrel, and with a broad thin flat chisel, take fine straight cuts down the sides. Do not try to hold the radius of the barrel for fear of rounding the edges too much by forcing the wood out, as this leaves an opening when finished.

Cover the bearing surface of the barrel with lampblack and only remove the dark impressions left by it. Extreme care is necessary to remove only that amount of wood which corresponds to the radius of the underside of the barrel. The long headless screw should be kept in place.

At the forward point in Figure 77, notice that the recoil shoulder is a true square; the guard extension lug-hole can only be seen coming up to the proper distance to meet the recoil shoulder on the receiver. At the radius point will be noticed the rounded bearings of the receiver at the rear. This greatly increases the strength of the wood at these points when the receiver is imbedded, and also helps absorb the recoil, for by forming the rounded section, you place the second recoil shoulder at the rear, which is impossible in a machine-made stock. One more position which should not be overlooked is in Figure 75, which is the projection on the right side of the receiver. The sides may be fitted very closely, but the wood should be relieved away from the radius or curve which blends in on the side. There should be just a little clearance at this point as you continue to fit in the receiver, because it has a wedge effect while bringing the receiver down in the stock. If these instructions are not followed, it is liable to cause a check ahead of this shoulder and in very brittle wood it may extend a considerable distance.

Having the barrel and receiver practically in position, notice is taken of the odd cuts for the projection on the left side for the magazine cut-off. This houses the cut-off and also the shell ejector. When fitting in the rear tang of the receiver, do not allow too much wood to build up around it, but continue to remove the surplus forming the handhold up to a point about $2\frac{1}{4}$ inches back, where the comb begins to form. The reason for paring down along the sides of tang is that many times the end grain will chip out in removing the receiver.

When fitting in the receiver it should first be fitted to half its height or half the diameter of barrel and receiver. Receiver and barrel should assume a snug fit between the wood and tang. To avoid future splitting of the handhold or grip it is a good plan to relieve the wood adjacent to rear of tang for a distance of $\frac{1}{32}$ inch.

A slight pressure should be evident between the barrel and the tip of forearm when the barrel cut-out is completed. This should not be so great but that a slight pull, one from the other, would separate them about $\frac{1}{32}$ inch. From the tip back to the receiver on the under part of the barrel there should be a good $\frac{1}{32}$ -inch clearance between this and the wood; however, the side bearing should

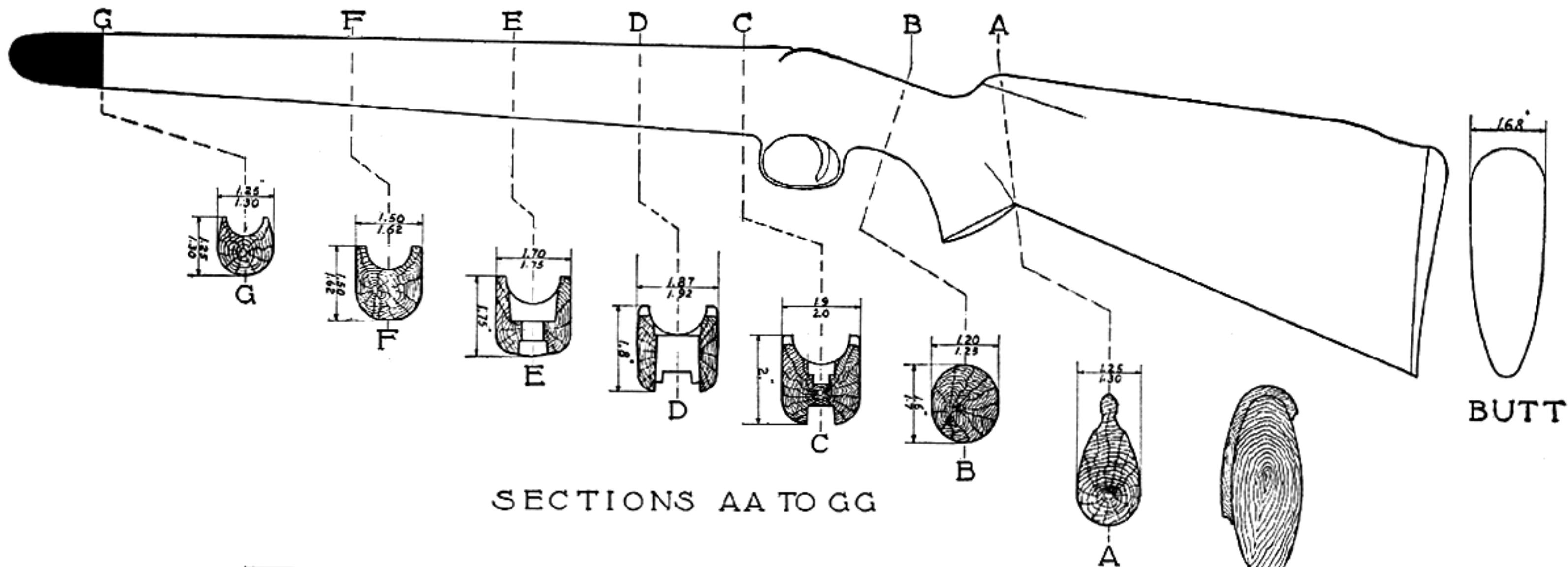

SECTIONS AA TO GG



COMB - NO UNDERCUT

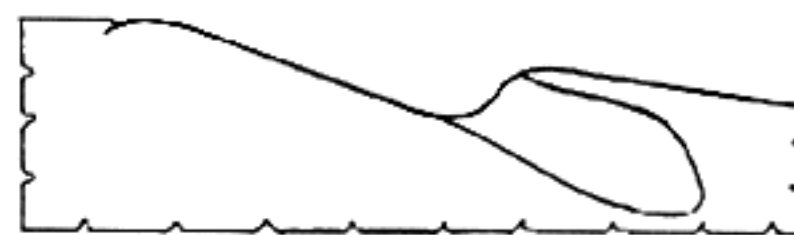

COMB - BROAD UNDERCUT

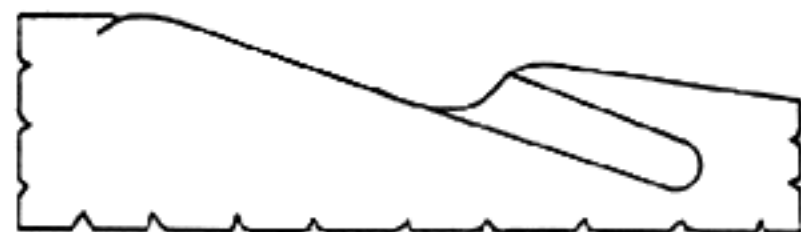

COMB - MEDIUM UNDERCUT



COMB - NARROW UNDERCUT

APPLIED CHEEK PIECE

BUTT

Fig. 77

Sporting stock layouts for Springfield Model 1903 rifle. Sectional views of average measurements for laying out on stock blank

be tight. The same rule is applicable to target-rifle forearms. When fitting a barrel band for either a sporting-type or target rifle, cause the band to bear in the wood with a clearance of $\frac{1}{64}$ inch between barrel and band. No undue pressure should ever be applied to the barrel.

When work has progressed to this point, drill the rear guard screw-hole. First make a pointed screw or use an extra guard screw, cutting it off to $\frac{1}{4}$ or $\frac{3}{8}$ inch on the threaded portion and file to a point in the lathe, or drill press. Then with a hack-saw on which the teeth have been ground down on the sides, cut a screw-driver slot in the center of the point, and screw this in the tang of the receiver. Place the barrel and receiver in position, and gently tap the tang, producing a center mark from which to start drilling for the guard screw-hole. With a center punch, increase the depth of the mark. Then use the centering device as described.

Drill-press Centering Device—Figure 78 illustrates this centering device, which is clamped

After the centering device is set up in the drill press as shown in Figure 78, with the $\frac{3}{8}$ -inch rod placed in the hole in an upright position, the guard screw-hole may be drilled. Set the trigger guard in place and use a $\frac{1}{4}$ -inch drill in the rear guard screw-hole as a guide. Place the center in the mark made by the center punch and bring the drill down into the guard screw-hole. This method aligns the hole perfectly. Now remove the guard and open the hole already drilled with a $\frac{21}{64}$ -inch drill, still holding the stock in position on the center in the fixture. Drill up to the center. Remove the drill and continue drilling until there is only a thin web left, then insert the guard-screw bushing. The rear guard-screw bushing is very essential; it not only separates the receiver and the guard, but it also gives the correct distance between the receiver and the guard. I always exercise great care in inserting this correctly, so that the two holes will be in perfect alignment and the bushing firm in the stock.

If a drill press is not at hand, and you have no

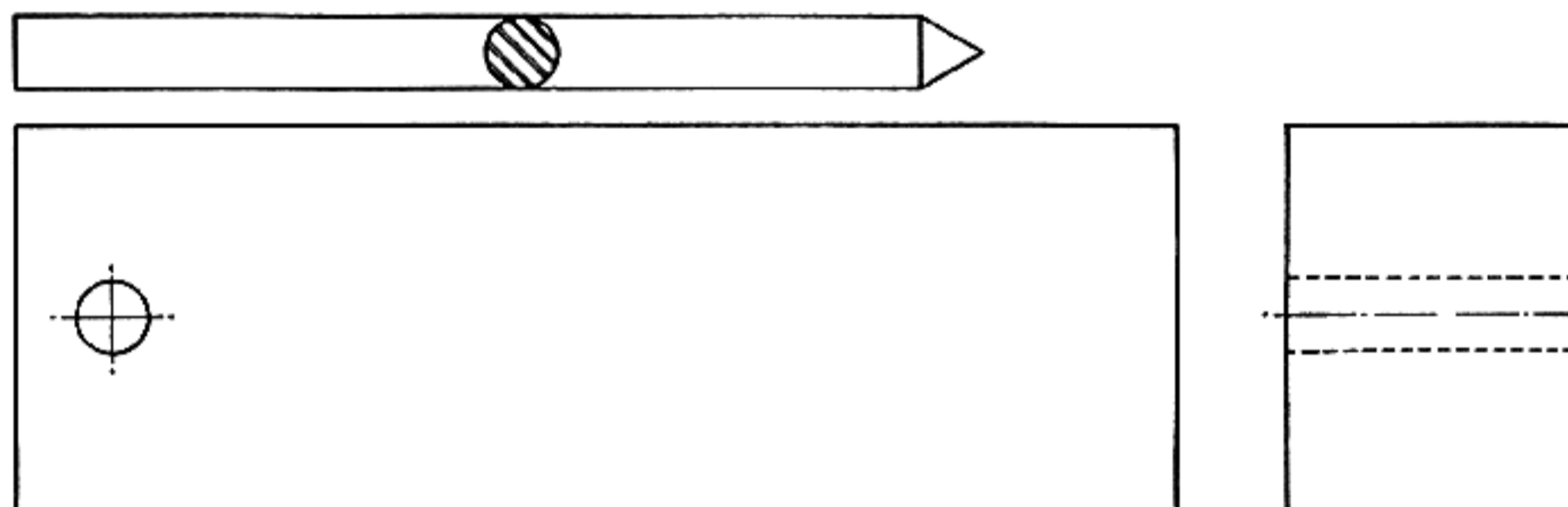

Fig. 78

Centering device used on drill press to align screw holes when fitting actions into stocks

to the table of the drill press by a C-clamp. Such a fixture is used to drill holes in line and is the only method by which holes will come in the exact opposite location.

This is a very simple fixture to make. The base is a piece of $1\frac{1}{2}$ x 2-inch cold-drawn steel with a $\frac{3}{8}$ -inch reamed hole to take a $\frac{3}{8}$ -inch piece of drill rod which has a center on one end. Line this up on the table by catching the drill rod in the chuck, and bring down the spindle, the drill rod entering the hole; then clamp. Remove the center and place it in position in the hole and the work on the center. With the proper-sized drill, feed it down until it meets the center. There are endless operations such a fixture can perform on the drill press. Being such a simple centering device, it is possible to clamp it in various positions, not only in stock work, but in metal work as well, where an offset hole is required.

centering device to work with, the hand drill answers just as well when used with due care. Proceed as follows: From the center mark in the rear of the tang seat, with a $\frac{1}{8}$ -inch drill, drill half-way to the rear guard-screw hole, which has been used as a guide to direct a $\frac{1}{4}$ -inch drill to the same distance, the two openings meeting with the centers slightly off. Allowance should be made for this when drilling. With a $\frac{3}{16}$ -inch drill open the $\frac{1}{8}$ -inch hole to the center, meeting the $\frac{1}{4}$ -inch one drilled from the bottom. Remove the guard and check to see how close the two holes meet. If they are not quite in the center, correct on the succeeding drilling.

With a $\frac{1}{4}$ -inch drill starting from hole in the tang seat, meet the $\frac{1}{4}$ -inch hole from the bottom; then, with a $\frac{21}{64}$ -inch drill, open to this width and insert the guard bushing. When drilling these holes, grind the drills until they are quite pointed,

with a considerable amount of clearance so that they follow the center more readily.

With the bushing in place, finish fitting the guard to the receiver. When the receiver with guard is fitted to the stock, and before the front or rear screws are tightened, an opening of about $\frac{1}{32}$ inch should show between the guard and receiver. The front screw should be tightened first when the two guard screws are drawn up, pulling the guard up to meet the receiver, and approximating the barrel at the tip of the forearm, allowing a slight pressure to spring them apart as described. Now seat the rear screw, pulling it up very tightly, binding the receiver and guard together, so that they will be immovable when recoil takes place. When this screw loosens, moderate accuracy is usually the result. For this reason, in stocking a target rifle, after pulling these screws up rigidly, I always place anchoring screws in front and rear.

The guard may be fitted somewhat tight, so that a blow with the hand or a small piece of wood will seat it in place. Light taps with a small mallet may be used, providing you do not use the mallet as a hammer to drive in the parts. When the guard is to be removed, hook the index finger in the trigger guard and tap lightly in front of it on forearm, which easily removes it from the magazine mortise. When fitting in the tangs of the rear and front of the guard, the edges naturally blacken the sides. The sides must be tight, or the fit must be so that metal and wood come together with slight friction; therefore, do not be deceived by the lampblack marks and remove more than the necessary amount of wood. Light conditions will at times deceive, especially when shadows convey the impression that more wood should be removed than necessary. At the tang of the receiver, the line of approximation must be close, but not to the extent that wood is broken out when removing the former from the mortise.

Remember that all parts must fit perfectly and the work proceed slowly and with patience. Forethought, good judgment and determination will solve most of these difficulties. Bring into play those tools that are the most convenient to use. I might tell you to resort only to those designated for specific purposes, but on the whole it would be poor advice, for I have found that many men "use a shovel to better advantage where a pick should be used."

When fitting the barrel to the forearm the channel should be slightly narrower than the barrel, for when you scribed the lines along its sides, you turned the scriber inward. The barrel rests on these edges not quite half-way to its depth in the

groove. Work away the lampblack which has left its tracing on the bearing points, using extreme care to remove the thinnest cut possible with more freedom in excavating the heavy bearing points that are made by the receiver in the wood. Finally the barrel will rest on the bottom of the radius, but not seated to quite half its depth for the reason again that the lines are made to encompass a narrower space than the barrel. They should be obliterated and new tracings made which impart the illusion that the space between will be too great; this makes one doubly careful. Wide thin chisels are used subsequently and for final hollowing-out purposes; to avoid tearing the wood they should be brought to the keenest edges. The cuts must be straight down, overlapping each other, and scarcely scraping off the surface. Lastly, the radius at the bearing points shown by the lampblack should be removed with round pattern-maker gouges.

When the final fitting of the guard is in order, assemble the floor-plate catch. You have left between $\frac{1}{8}$ and $\frac{3}{16}$ inch to pull the guard in place. At this stage of the final fitting, pull the guard and receiver together with the front and rear guard-screws, which furnishes the opportunity to make any final necessary correction.

Remember when using a thin flat chisel to make the cut straight down. Beginners are liable to undercut the sides, which calls for a deeper cut and results in an unsightly and disappointing opening. The latter mistake is common not only to the novice but to experienced cabinet makers and carpenters in their first attempt to inlet an action. It is far better to cut a slight angle in the opposite direction than to hollow out the wood, thereby enlarging the bottom.

Do not lose sight of the fact that the top line of the stock must be held straight as the cut-off housing is fitted, and that the recess is considerably deeper than in the service stock. Keep it straight from the tip of the forearm back to the end of the cut-off with the slope of the receiver tang, allowing the cut-off to come in the center of the plunger catch to remove the bolt. Notice also that the wood projects high over the cartridge opening on the right side. It must be removed from the radius of the forward projection, back to the outlines of the tang; this can be done while the receiver and guard are assembled and then completely finished on the final shaping.

If one should wish to restock a number of Springfields in the course of say a year, it would be better to secure an extra receiver from the D.C.M.*, using it as a model when inletting this

* Director of Civilian Marksmanship.

part. It takes less time to inlet the receiver alone, but when it is done in this manner and the barrel is afterward screwed in place, the succeeding steps are identical with those described for the inletting of the two parts jointly.

To do a refined job, sandpaper carefully the entire mortised surface, being careful not to touch the edges. A workman with some experience and with sharp chisels may, by the exercise of a little care, inlet an action so smoothly that sanding is superfluous.

Before laying out for trigger and sear seat remove all metal parts and observe again how this was done in the old stock that is being used for reference. Make the opening no larger than the space necessary to clear a full travel of the sear and trigger when operating.

Templets are used in turning out stocks on a production basis, but the beginner is advised against their employment except in an experimental way. In Figure 76 the proper dimensions for a Springfield guard and magazine templet are given, which in this case is completed $\frac{1}{32}$ inch less in all directions, so that when inletting, extensions may be made to a hair-line fit. If the student has no sketch such as Figure 76 illustrates for other arms like this to go by, a good plan would be to secure a piece of No. 18 gauge sheet brass, and scribe first a center line, and square one side; then with a combination square you may scribe two lines at the top and bottom of the sheet, representing the front and rear guard-screw holes the correct distance apart. Then with the dividers lay out widths and connect these, forming the lines rather deep. Allow all measurements to be $\frac{1}{32}$ inch smaller than the figures on a side. Templets should be $\frac{1}{16}$ inch smaller in width and also in length. Never make a templet by cutting out paper from sample pieces, pasting the pieces on brass or tin, and filing to the paper; rather, measure the templet to be made, and lay it out with accurately scribed lines. File to the center of the scribed lines and drill two small holes on the ends for the purpose of locating the templet, and holding it in position for scribing.

I am firmly convinced that almost any man who has seriously completed his first job of inletting on a Springfield is entitled to a feeling of superiority over the average gun crank. Many mistakes will have been made on the first one; the second will, however, be much more simple, and the experience gained is sufficient to do this work on any bolt-action rifle, the essentials being the same except for minor differences, such as location of screw holes, side magazines, trigger guards separate from magazine, etc. No high-grade bolt-action rifle is

more worthy of a fine, well executed stock than the Springfield or Enfield, especially since their popularity is bound to continue for years to come.

Due to difference in shape and construction of a Krag action, the method of inletting is not quite the same as for the Springfield M-1903 action. The magazine and action are combined, necessitating rather odd cuts, but generally speaking the same mechanical rules apply to both.

The first operation is to lay out the magazine and action in proper relation to the size of the blank, having first scribed a center line the full length on top and bottom. Next, measure up to the recoil shoulder. The magazine on a Krag is part of the action, and the recoil shoulder is one solid piece which forms the rear end of the magazine. Scribe a line at the forward end of the magazine and place another line at the end of the receiver. Scribe these lines across the blank. The receiver end measures 1.3 inch; as with dividers, lay this out on the receiver cross-line, also at the recoil shoulder. Then draw lines between the two, extending the lines rearward at least one inch further since the diameter of the receiver is the same at the front as at the point. The full-length line of the left side must be held, for this continues from the end of the receiver to the magazine cut-off. You will notice on the left side of the recoil shoulder a recess, which has rather an odd form. Remember to lay this out on the top of the blank, as it acts as a recoil shoulder. Many make the mistake of cutting it out square with line on the left side.

When the above scribing is completed, lay out the center section for removal by drilling. Do not approach nearer than $\frac{1}{8}$ inch to any scribed lines. Measure downward from half the diameter of the receiver to the bottom of the magazine, and mark the depth on the right side of the stock. This is the final depth when the action is fitted, and with a $\frac{3}{8}$ -inch bit bore out the surplus wood. Next, cut out the recess for the magazine. Remember to keep the larger radius in the front of the magazine and recoil shoulder at the left side.

Before fitting in the magazine and action, grind the tang of the receiver with a radius on both sides, just as you ground the Springfield receiver tang. This makes a much neater finish than to allow a sharp edge at the end. Cover the contacting surface of the magazine with lampblack as previously described for the Springfield. Gradually work out the wood for letting in the magazine action and barrel. As these parts begin to go into place, scribe the outline and rough out all the surplus wood. Continue to spot and fit, slowly and carefully, until all metal parts are properly placed,

leaving no open seams between metal and wood. There should be no hesitancy in constantly resorting to inspection of the old stock to familiarize oneself with the general outline of the cuts and avoid thereby heartbreaking errors. As the Krag's recoil shoulder is at the rear of the magazine, on the left side, it is very important that the wood in this location fit closely against the magazine.

The guard-screw holes are located the same as on the Springfield, except that in this instance there are two to locate, front and rear. The pointed screw, made for the Springfield rear guard, may be used to locate both. Use it first in the front screw hole, then in the tang, tapping gently in order to secure an impression. Center-punch the two holes deeply. The front guard-screw hole is straight; bore it through with a small hand drill, following with a $1\frac{7}{64}$ -inch drill ground pointed to enlarge the hole to the required size.

With a small caliper, using the old stock again as a guide, measure the thickness of wood between the magazine and the bottom of the stock, allowing a full $\frac{1}{4}$ inch for a tolerance to work to. After measurement has been made, remove the wood from the bottom of the blank to the required thickness, keeping in mind that the rear of the trigger guard slopes gradually, for which a slight angle must be allowed.

To let in the trigger guard, place barrel and action in position, and with the long screw which was used for the Springfield to set in the receiver, line the guard in position. Having squared the sides of the blank, with a die-maker's square set the blade to the center of the tang on the receiver. With this setting, locate the trigger guard by scribing a line in the center at the rear; then place the guard in position and scribe around it. It will be in the proper location in relation to the rear-tang screw hole, and by holding the front end in position, inletting may be proceeded with. Make wary use of lampblack coating, and try for a hair-line fit, not forgetting the rear slope where the wood must be heavier. When the guard is in about half-way, try to catch the front guard screw; if unsuccessful, mortise a little deeper, or until it is possible to enter the screw into the magazine, pulling the guard up tightly. Remove the screw, action, and barrel, and with the trigger guard in place, drill for the rear guard-screw hole. This hole does not require a bushing as in the Springfield; consequently it should be finished to size of the screw, or slightly larger. I prefer a letter-F drill for this opening, which measures .257 diameter.

It has often been suggested that the under surface of the metal parts be coated heavily with

lampblack to locate screw holes. It is, however, one of the most inaccurate methods, for the reason that the oil and lampblack run on the surface of the wood, making it most difficult to locate any given point definitely. The correct way is to use a center screw, which eliminates all guess work. The latter method is used in die work, when it is necessary to locate holes tapped blind in a new die.

After the drilling for the guard screws is completed, set the trigger guard down to the desired depth, using the front and rear screws to pull it in place and to produce the impression made by the lampblack. Once the guard is seated to the proper depth, the surplus wood may be cut away to the desired level. Lay out for the trigger, removing wood so that both trigger and sear work with freedom. Coat the sear with lampblack and relieve all wood where the markings show. Follow instructions on relieving wood from the end of the tang to the comb as given for the Springfield. Then cut out the left side where the magazine plate fastens. Lay the outlines of the cut-out from the inside and then saw this section out. The rear has a straight cut-out, but the front must be done to the end away from the plate with a radius at the top and bottom, in order to assure a satisfactory fit. The top radius in the front is rounded off, allowing its lines to blend with adjoining ones. It is a mistake to cut out squarely in front and at bottom, since the surface is curved in those localities.

Having acquired knowledge and experience in the art of inletting the Krag and Springfield, let us consider another type of stock—that for a shotgun. The construction of a new stock of desired form for the cheaper grades of shotguns often costs more than the original gun. Sufficient experience to carry on an experiment of this nature enables anyone to make an appreciable saving; besides, it will furnish the training eventually to restock creditably an arm of finer quality to which the fitting of a mediocre stock would be sacrilege.

The selection of wood should be in keeping with the grade and ornamentation of the metal parts, and for a high-grade gun the better and consequently more costly types of French walnut are best. Anson and Deeley actions with cross bolts and box locks represent practicality and the standard construction used in all good-grade shotgun actions. The general design has changed but little since it reached the contour we are now familiar with. Minor details have been incorporated, but the general architectural design has remained about the same during the last few decades. As in the stocking operations for rifles, study of the cuts and mortises of the original stock will simplify

many a vexing problem that might otherwise not be solved until too late. Let us imagine that our new stock is for a fine arm, say a William Cashmore with pistol grip, or William Ford.

Begin by removing the sears, top lever, spring, and safety arm from the trigger guard, and stripping the action ready for laying out on the stock blank. The latter is usually purchased roughly cut to approximate size, but it will be necessary to cut off the forward end at that angle coincident with the required drop. To determine this, place the barrels in the action, resting the assembly on a piece of straight board or plate with the top rib down. The blank should be laid parallel and an estimate made of drop at heel and comb. On the back of the action, when it joins the stock, use a bevel protractor to find the correct angle as the action rests in this position. Transfer this angle with a scribe to the forward end of the stock, at a point which will insure proper stock length over all when the latter is fitted to the action. Square top and left side of the stock and also the face of the cut end. If the amount of wood to the right of the scribed center line is not sufficient for the desired cast-off, the center line should at this stage be moved far enough to the left to make possible the inclusion of more wood to the right of it.

The scribed center line, drop at heel, and cast-off are determining points for location of the tang of the butt plate. The center of its tang and width measurement, with length, establishes its position on the butt.

There are two types of action tang, the long slender one and the one that is simply a broadening out of the rear portion of the action. With dividers lay out its form $\frac{1}{32}$ inch under full size, and cut out with a thin narrow flat chisel. Penetrate to a depth of about $\frac{1}{8}$ inch, avoiding encroachment on full width. Bring this marking up to the action and with a $\frac{1}{4}$ -inch thin chisel start to remove the wood. Now check with the action in place to get an idea of how well the cuts have been made. With a round gouge relieve the radius at the step, where the narrow portion of the tang begins, and also the face of the cut end.

Before it is possible to fit the action and the tang in place, it will be necessary to cut out for the square locking bar which extends out about $\frac{1}{8}$ inch. Having completed this, the fitting of action and tang may now be done. Place first a light coat of lampblack on the contacting metal and relieve only the heavy spots with fine shavings. When the action barely fits into the wood, attach the barrels and check for drop at comb and heel, allowing enough surplus wood for planing so that the required drop may be obtained when the action

is completely inletted. The latter will have been accomplished when the metal is adjusted to the wood both on the face and tang with a hair-line fit. Since the wood was left full at the bottom, it is in order now to remove the surplus to form the pistol grip. Allow $\frac{3}{16}$ inch of wood from the bottom of the action. Many make the mistake of cutting the wood almost flush with the bottom side, not realizing that the bottom plates are yet to be assembled to the action.

With the butt clamp shown in Figure 22 fasten the action in place, and lay out the bottom side for the trigger plate. Stay $\frac{1}{32}$ inch inside the lines, and with a thin narrow chisel bring the depth down about $\frac{1}{8}$ inch; next remove the butt clamp and with a die-maker's square, measure back to trigger housing. With a $\frac{3}{8}$ -inch bit, bore in $\frac{1}{8}$ inch; then with a Forstner bit extend the opening a trifle deeper. Lay out for the safety extension and bore out some of the surplus wood, also tool out more so that these will go down in place. With a $\frac{5}{16}$ -inch bit bore into the rear safety cut-out and remove the wood down to the bored hole, meanwhile studying the cut-outs on the original stock. When the plate has been let almost the required depth into the wood, place the action in position and check up the rear screw hole. The former will still extend up on the wood, indicating however, just how close it is to the proper depth. Again, clamp the action in place with the butt clamp and apply a light coat of lampblack, starting the plate down into the wood. Cut out until you are able to screw action and trigger guard together. Extreme care must be taken on all cuts, especially at the bottom bearing, where the large front screw holds the trigger plate in place. With calipers determine the distance between top and bottom cut-outs of trigger guard and action tang. Notice that the curve of the trigger plate, at the rear, is rather abrupt and is the commencement of the curve of the pistol grip; also that the cut-out for the safety lever is situated rather close to the rear screw hole. This bearing must be held with exactness or the recoil will be an ever-present factor in loosening the action. There is but a small bearing on the sides for the trigger plate to rest on; therefore, this must also show a full bearing cut-out only for the small screw and spring on the left side, which is part of the single-trigger mechanism.

After having the trigger plate set in at the proper depth, make a pointed screw for the large screw hole at the front end of trigger plate, similar to the one made for the Springfield rear guard screw. Insert it with the butt clamp, still holding the action in place. Next remove the plate, also the

pointed screw, and with a center punch deepen the center mark already made.

Again assemble the plate with the butt clamp still in position, and drill out the rear screw hole, using a drill the exact size of the screw. Place the rear tang tapped hole on the center of the centering device, the same as you did with the Springfield in order to drill the rear guard-screw hole. If a drill press is not available, use the method already described for drilling, which if carefully handled is amply sufficient. In any event, great care must be exercised so that the trigger plate will be the proper distance between the top and bottom of the wood, since the relative position of the hole changes whenever the plate is let in a step deeper. This naturally makes it difficult to pull the action solidly against the stock and leaves an unsightly opening at the bottom when assembled.

After the rear hole is bored, the one for the front screw should be prepared. This is a tapered screw, therefore check its size in a drill gauge. Choose a drill for the smallest size of the taper, which is at the threads; then select another which just fits the hole in the tang, and center the wood with this. Check the drill used for the small end of the screw, and place the stock on the center located by the pointed screw. Sense of touch readily reveals when center and center mark coincide, but to make sure, repeat the trial several times. Drill through and assemble the trigger plate. As this is screwed down, it forms a solid bearing in the wood because of the taper on the screw.

The two screw holes are now completed, and the front screw is in position, so the trigger guard may be set in. The rear screw, on a Cashmore, holds the trigger guard in position as well as the trigger plate, but on nearly all other Anson and Deeley actions, either one or two wood screws, accurately alined, hold this guard in position. Be particular about cuts made with the chisels on the end of the tang, as this is on a sharp angle to the bottom. Have wood and metal come flush, for an opening here is inexcusable. After the guard is in place and the long screw is in at the proper depth, the most difficult part is completed.

Disassemble, and make the necessary other cut-outs in the stock for the safety device and the top-lever spring; then assemble the safety levers on the trigger plate and make the required cuts for these in the bottom, removing just enough wood for all the working parts to clear. Put this to a test by reassembling and screwing together for a trial as to free-working quality. There may still be a few minor cut-outs for tumbler clearance. These are made on the face of the stock to clear

the sear, which may require the removal of a slight amount of wood indicated by the lampblack impression. When this assembling and fitting is completed, all parts are removed, washed in gasoline and thoroughly polished before final relationship between stock and action is established.

In the process of this work, a great variety of chisels have been used, including bottoming and several widths of narrow chisels to make the cuts for the safety lever which extends under the tang. Thin wide chisels were utilized for relieving the sides, as well as radius gouges in dealing with curves and angles. As I have explained before, it is best for the beginner to allow his choice of chisels to conform to individual needs, which can be determined only as the work progresses. Intuition, common sense, and personal equation will be guiding helps, and if instructions are carefully and painstakingly followed there is no reason why anyone with the least bit of mechanical ingenuity should not surmount difficulties which at first seemed impossible.

While on the subject of shotguns, I am not forgetting those of domestic make, such as the Parker, Smith, Ithaca, Fox, etc., with the multitude of cheaper arms and the hammer guns made in the interior between 1870 and 1900. All these may be restocked successfully. Altho not great, the demand for hammer guns still exists, and a number of European gunmakers continue their manufacture. It would be impractical to give a full description of inletting all hammer shotguns, but if the reader has working knowledge of the requirements of this subject as it pertains to a representative arm of high grade, he need feel no hesitancy in undertaking the fitting of a stock in any of the lesser grades.

Let us now touch upon the Fox 12-gauge double shotgun, where the cuts for the action on the end of the blank are started a mite differently from the way used for a standard box action, like the Parker. The safety pin of the Parker and Fox are similar, both being drilled on an angle through the wood to meet the safety lever. The method already described relative to placing the safety pin applies equally for properly penetrating the wood when stocking these two types, as do also the instructions for laying out and inletting of action. It is, however, necessary to consider the fact that a Fox 12-gauge action is wider and relatively heavier; consequently choice of wood block is limited to one between $1\frac{7}{8}$ and 2 inches in thickness. Saw off the end of blank at the angle giving the required drop, remembering also length from trigger to butt plate, with a generous surplus at the butt. Assuming that the blank is roughly shaped,

place the action against the angle at the forward end and trim down to the start of the comb so that the slope of the tang coincides with the curve of the grip.

This completed, disassemble the top lever mechanism. Observe that the side extension pin which engages the safety is riveted on, and the only part removable is the bottom screw which engages the plunger and spring. In removing this the top lever may be moved at will.

With the old stock for comparison, notice that the center has been excavated for a distance of about $\frac{1}{2}$ inch back. With a $1\frac{1}{16}$ -inch wood bit bore this out, keeping the same angle on end. A little over half of the cutting surface of the bit will be engaged, but with the end of the blank held securely between the vise jaws, a very good job may be done. Use a round file to approach the lines made for width. Measure down to the center of the extension pin and lay this off on the left side, and with a $\frac{3}{8}$ -inch bit bore to the required depth. The center you leave is what you will use to drill through to meet the safety lever.

You are now prepared to proceed with the inletting of the tang. Having disassembled the safety slide, spring, and connecting lever, there will come into view a round button for the lever to work in, and as this cannot be removed, it will be necessary to cut out a clearance for it as you fit in the tang. Follow the regular instructions given as performed on the Cashmore, from this point on, namely fitting in the trigger plate, guard, etc.

The Ithaca, Baker, Winchester, and Lefever are all on the same order, and when one or two complete inletting jobs on shotguns have been mastered, the others will be comparatively simple. It takes time and patience, but when interested in such work, one's mind is so occupied that the time is spent quickly and pleasantly. For myself, no more agreeable occupation exists than to apply my time to this class of work; it is a labor of love.

The following will be a brief description of how to let in a side-lock action for an L. C. Smith or similar double shotgun with side locks. This method is applicable to most side locks, since all except a number of British makes are very much alike. Two additional types of locks are encountered: those of the bar and the back-action variety. Side locks are those which are let into the side of the bar of the action; in others, the whole of the lock is situated behind the action body. The former type is called *bar-action side lock*, and the latter *back-action lock*. In the L. C. Smith the locks are of the bar-action type.

It might be well to consider hammer guns at this stage of our description, for the reason that the locks of all hammer guns are necessarily side locks, and their general design is identical with the hammerless side locks which we are now touching upon. The parts are all situated between an outer lock plate and an inner bridle, and the principles of mainspring swivels, tumbler, and sear are exactly the same as in hammerless side locks. The only notable differences are the shape of the tumbler and the absence of the cocking lever.

Before the locks are let into the stock, it will be necessary to let in the action and trigger plate. Follow the instructions given for the Cashmore, and when inletting the trigger plate into the stock, be careful to imbed the plate completely, in correct position; for when the lock is let in, the arm of the sear must bear upon the wide part of the trigger and not on the outer edge. If it rests upon the outer edge, when pulled to disengage the nose of the sear from the tumbler notch, it produces a twisting action with less rapidity and insufficient strength properly to disengage the sear without considerable effort.

Having removed all parts from the locks, and leaving only the plate to work with, proceed to inlet this into the stock. Remove the wood from the sides of the stock so that it is flush with the sides of the action straight back, preparatory to letting in the lock plates. In doing this, work carefully so that no more wood is removed than is absolutely necessary. See that the lock plates have all the support possible where they engage with the wood, and after they are in position drill out for the sears to meet the triggers. Assemble all parts and coat them with lampblack. Cut out for the tumbler, main spring, sear spring, and bridle. Remove only enough wood so that the parts will just clear, and the pockets thus formed will give support where necessary. Be very careful not to remove any wood where the edges of the lock plates come which would serve to leave open spaces for water, dust, or moisture to enter.

It is advisable to fit only one side at a time. Determine whether or not the sear has a good bearing on the wide part of the trigger by looking through from the opposite side, and then drill for the side-plate bolt, using the centering device as previously described.

The action and trigger plate should be kept screwed together; this gives a better support to the wood, since when the locks are completely inletted, there remains but a flimsy skeleton of wood. Great care must therefore be exercised in the manner in which the stock is placed in the

wise; with gently applied pressure when shaping the butt end.

Here, again, constant reference to the cut-outs in the old stock, if there is one, will be a most welcome help. If this assistance is not available, screw the action together, make a free-hand sketch of the openings, and jot the measurements down on paper. You will find that by doing this, fewer errors will creep in.

Fitting forearms to double or single shotguns is not necessarily a difficult operation. First, strip all the parts from the fore-end iron, such as the plunger housing and plunger roll or catch. This will leave the bare forearm ready to fit into the wood. When a fore-end iron has the automatic ejectors attached, I would not advise the beginner to disassemble these or any parts of a self-ejecting double gun without previous experience or instruction in this departure. The several parts are made to fit so closely, that if they are once out of adjustment it requires a mechanic with the proper experience to restore them to working order; hence it is far better to leave the automatic ejector in place, and fit it into the wood along with the iron.

Select a piece of wood which matches the butt stock, allowing width, length, and thickness for finishing. Plane the top, bottom and sides square, and then scribe a center line the full length on the top and lay out the width of the iron with dividers, allowing $\frac{1}{32}$ inch to finish to on each side. Start the center cut-out and begin letting the iron into the wood. Coat the metal with lamp-black and remove the wood only where the heavy bearings show. Having set in the iron to the required depth, begin to form up the wood for the end radius on the iron. Fit this until wood and metal come flush, with a perfect bearing on the radius. The iron should be fitted deep enough into the wood so that there will be a surplus amount of the latter to finish against the bottom rib, when the radii of the barrels are let down into it.

When this has been completed, assemble the barrels to the actions and cut out the contours for the barrels. As you set the iron against the radius on the end of the action, coat the barrels with lampblack to form a bearing the full length of the wood and also in the front, against the under side. Now let in the fore-end lock and scroll-iron tip, if any; then locate screw holes and fasten all parts together in order to see if the fore-end assembles without difficulty. When this is done, begin to form up the outside to the desired design, such as a beaver tail, or any special form that fancy dictates.

To protect the barrels when shaping the outside of the fore-end it is often convenient to make a wooden form to take their place in the channels hollowed out for them. Make special long screws to fasten the fore-end to the form, then remove two of the screws from the fore-end iron and use the former to fasten the fore-end to the form. This saves the trouble of frequent assembling and makes possible a constant understanding of the proposed symmetry that is sought after.

The inletting of shotgun actions requires sometimes a goodly amount of forethought, because of deviation from the accepted standard or normal type. In this sphere is included the Greener and the product of several German makers who entertain the same idea relative to locating the safety on the left side of stock, set in a scroll housing with the safety bolt running through to the opposite side. In restocking an arm of this make, particular pains should be taken to locate this device accurately as well as to fit the housing of the safety into the wood so that no opening will show. A volume could be written on this subject; however, enough of the important details have been set down to enable the beginner to embark on the venture of inletting a shotgun action, and this is my principal object, because I know that after the experience of a first attempt, faithfully carried out, the second cannot fail to reflect credit and be a stimulus to further effort.

The French Lebel and the Russian 7.62 mm. and the 8 mm. Mannlicher are similar. They are of the clip-feed type and the most difficult of all actions to inlet, according to my opinion, because of the long narrow magazine and the fact that the action must be let in first. Remove all parts possible and inlet the barrel, action, and long narrow magazine and trigger, following the general principles already described. The magazine and guard on these rifles are easily thrown out of alinement, because of their shape and the difficulty of following it in mortising. Screw holes are bored in the manner I hope every reader is now familiar with. Figure 50 will give the student an idea of a Steyr action as it appears when completed.

Among the more difficult makes to inlet is the Mannlicher-Schoenauer. Here, also, the barrel and action are first inletted, reversing the order in the Springfield, with magazine, trigger plate, and guard following. This type of rifle has a well-shaped full-length stock which instils the desire in many American riflemen to duplicate it in a Springfield, Mauser, Winchester, or Remington bolt action. Our usual care multiplied several times must be given this inletting. First the receiver

and magazine are inletted, permitting the receiver to stand above the center line $\frac{1}{16}$ inch or more and allowing $\frac{1}{4}$ inch between the magazine and action. Then screw the barrel into the receiver and gradually inlet it the full length. Be careful not to have a twist in your channel forcing the barrel to one or the other side, and see that barrel and stock come together without the least spring between them. When penetrated to the depth of the receiver, begin to inlet both the barrel and action until they come down to the center line; then finish inletting the magazine and guard, pulling them together with the front and rear guard-screws until all are in their respective places, with the end of the barrel imbedded with enough relief to require only a little effort to spring it out of its channel. When work has progressed to this stage, remove the barrel and relieve the bottom of the channel, as described, along its full length, so that only the end has a bearing.

The inletting of a Mauser receiver and guard is similar to that of the Springfield, and less difficult for the reason that one does not have the cut-off housing or projection to contend with.

The Newton, Ross, Savage bolt action, Model 1917 Enfield, Winchester Model 54, and Remington M-30 have a stamped sheet-metal magazine which is separate from the guard, and for that reason all are rather difficult actions to inlet. The Newton, for instance, which is about the most complicated, has a separate magazine and set triggers in the guard, as well as the false tang or rear receiver fastening. The latter consists of a tang which also serves as the end receiver "hold-down." A screw passes up from the guard holding it and the tang in position. In restocking one of these rifles, I eliminate the long screw which comes through the pistol grip, holding the grip cap and rear of tang in position. The reason for doing this is that the Newton grip is situated some distance back, and when placing one in the usual position it is out of line for the screw hole; therefore the better plan is to drill to the rear of the tang for the substitution of a common long wood screw.

When stocking any of these mechanisms, as we have stated before, it is better to inlet the barrel and receiver first. On the Newton, this order may be reversed, but if there is any hesitancy on account of lack of experience, it will simplify the procedure to inlet the receiver and then the barrel. Remove the front screw which is a part of the floor plate, the floor plate being used to pull up the forward part of the guard. When fitting in the guard, cut out for the set trigger housing with the guard in position and for the separate sheet-

metal magazine the rear of which fits at the sides of a projection of the guard. Be very careful to get the mortise the right width and length and at the same time leave a small bearing for the magazine where the floor plate comes, and also for the magazine shell.

The Ross is very similar to the Newton, except that the Newton guard has more metal. The student will find all such actions much more difficult to manage than the Springfield or Mauser, but worst of all is the Savage bolt action. The thin plates of the magazine make a satisfactory fit all the more problematical, and add materially to our difficulties.

Few gunsmiths make a practise of restocking the old muzzle-loading percussion type of rifle, but many inquiries are received regarding such work. The price is usually prohibitive, since it requires special effort, and more time than the job is worth in most cases. However, if the novice should have occasion to make a new stock for such a gun, he will encounter no great obstacles, especially if he has an old stock from which to take suggestions. Every variety of factory arm, including Marlin, Winchester, Remington, Savage, Stevens, is submitted for restocking with some difference presented in each, usually of minor importance. In most of these the rifle is held to the stock by a single screw connecting upper and lower tang, which greatly lessens the task of inletting. The cuts in the wood are easily made, and these types are recommended for experimentation and to obtain the necessary dexterity in the use of tools. Stocks on the last-mentioned arms are turned out by machinery and very few fit the average man. Naturally, in making a standard product it was necessary to make a stock which would answer the general requirements of most buyers. Nearly every enthusiast has at least one in his collection, sometimes a very fine arm, and it is well worth the effort to equip it with a stock which adds worth and efficiency.

In some instances stocks are held to the action by means of a bolt running lengthwise from the rear. An oversized hole is bored starting at the butt end for a distance, abruptly assuming correct diameter of the bolt used to tighten stock to action.

There is only one positive method to drill this hole and that is to do it between centers on a lathe or drill press. Should this operation be attempted by hand with a brace bit and extension drill, it would be wise to have a blank large enough when the drill drifts from center to have a sufficient amount of wood to correct any possible error.

The following is a good method where access

can be had to a lathe or drill press. After selecting the stock blank you wish to use, cut the end on the proper angle for drop, also cut near to the required length. Lay out the center lines accurately at front and rear, and mark the vertical transverse center in butt and front end. Bore the large clearance hole first, then select the proper-sized bit of extra length and chuck this in the lathe; the former should run perfectly true. Measure the correct depth and mark this on the shank of the bit. Begin drilling from the center in the butt end of the stock and place the center of the lathe tail stock in the center which was laid off on the front end; start the lathe at a moderate speed, feeding the stock against the bit until the line marked on the shank for the correct depth is reached. Next remove the bit and use an extension drill. This is made by turning down the shank of a drill, then drilling the end of a piece of drill rod a little under the size of the drill, and sweating these together in an uninterrupted straight line. The drill selected must be of the same diameter as the bolt. Three or more sizes of bolts are used for this purpose: $\frac{1}{4}$, $\frac{5}{16}$, $\frac{3}{8}$ inch, etc. Grind the drill with a long taper for drilling wood with a considerable amount of clearance, and it is ready to chuck in the lathe. Start where the wood bit left off and go through until the drill emerges at the front center mark, making what should be a perfectly aligned hole.

On some arms there is an extension from the action which goes into the stock two or sometimes three inches, the bolt being fastened into the end of this as in the M-97 Winchester. If this is the case, drill accordingly by first boring the clearance hole to the proper depth, then drilling the one for the bolt which meets the center of the hole first drilled.

A number of the single-shot rifles have bolts running through the stocks, as for instance the old Ballard. The idea of a bolt through the stock is practical in that it keeps the stock tight against the action. In these types all that is necessary to tighten the action is to remove the butt plate, and with a long screw-driver draw up on the screw until it is perfectly rigid.

For restocking an automatic rifle or shotgun, the same methods may be applied, generally speaking. The position of the recoil spring where it enters the forward end of the stock may be laid out on the side of the blank, carrying the angle down to the butt end of the stock. The centers in butt and front end are in this case not placed the same as described above, the latter being higher, with the one in the butt nearer the toe. In the end of

the oversized hole which starts here from the front is a slight angle which corresponds to the end of the recoil spring; it is not of such a degree, however, that it prevents carrying the hole to the butt in a straight line. Proceed with boring operation in a like manner as described for mechanisms requiring bolt to hold actions and stock together. This method eliminates all uncertainty, whereas laying out the course of the hole with a brace and bit is unsatisfactory because accuracy is out of the question. Some makes of rifles and shotguns have part of their mechanism in the stock not always evenly distributed; therefore, for the sake of convenience guide your work from an opposite center. Figure 79 illustrates the inletting of a Remington automatic action. Note the gun brace used.

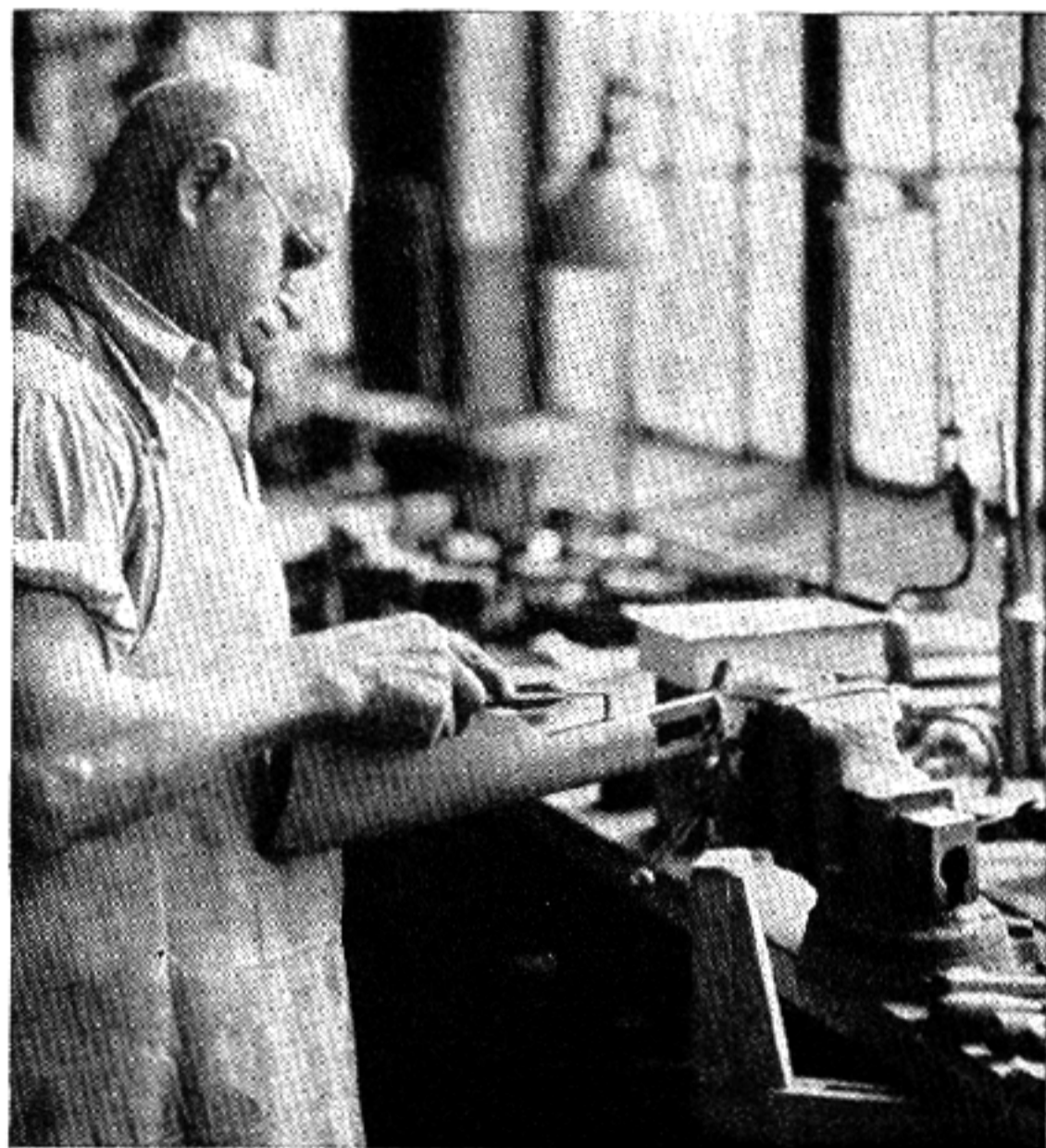

Fig. 79
Bench work. Fitting stock to an action. Note style of gun brace used

The Model 52 Winchester, at this writing, is popular; and since it is of the .22 caliber target variety, calls for restocking are common. The action is not difficult to inlet, as the receiver is cylindrical and the barrel and action are fitted together. Cut out the mortise for the magazine and trigger mechanism, and then fit in the bushing for the magazine release. Spot for the front guard screw, and then inlet the trigger guard, which is only a metal stamping; on this account you cannot expect as good a fit as in the case of a solid guard and magazine.

It has often been suggested that stock bolts be fitted through a specially built stock, and that this method be used on the service Springfield. True, such bolts are needed when soft American walnut is used. The Springfield is such an instance, but if the stock is of a better grade, such as French, Italian, or Circassian walnut, and if the recoil shoulder has been fitted with metal closely against the wood, there is no likelihood of its being split by recoil, providing proper fit has been maintained. While the following has been mentioned before, it is important enough to repeat.

When a receiver is being inletted on a bolt-action rifle, always relieve the radius at the end of the tang. The opening should show at least .020 between the wood and metal at the top. On the bottom relieve at least $\frac{1}{16}$ inch. When using the round gouge for this operation, begin a very fine cut at the top, and as it continues down, increase the angle of gouge and remove more of the wood as you go down with the radius. When a mistake is made, such as cutting out too much wood from the recoil shoulder, coat the action with oil in that locality and cut out the wood about $\frac{1}{8}$ inch and run in heavy, hot glue; then screw the guard and action together and allow to stand for 24 hours. You have thus formed a solid recoil shoulder which is as perfect as the wood itself and much stronger. When the above suggestions are followed, even in American walnut, the danger of the stock splitting has been anticipated.

When a stock splits it usually does so between the recoil shoulder and magazine opening or between the back of the magazine opening and trigger cut-out, and is due, most often, to the wedge effect of an improperly fitting receiver or guard driven into the space mortised for it. Never attempt to drive an action or guard down to secure bearing marks, for all the force that is required to obtain the lampblack tracing is a gentle tap with a light mallet. If confronted with the misfortune of a split stock, the very best plan is to insert a stock bolt half-way between the recoil shoulder and magazine; also one between the back end of the magazine and trigger cut-out. When stock bolts are used, counterbore deeply enough to make possible the covering of these openings with wood to match. Turn up the latter so the grain will run across the diameter, then cut to a length which can be trimmed off flush when completed. Use hot glue generously and work it well in against the screw head. The direction of the grain, both in the inset and in the stock, should be continuous, giving thereby as little evidence of its presence as possible.

If there is a choice in the matter, the operation should be done when the sides of the stock are roughed down to size. Let stand for 24 hours and finish flush with the sides of the stock. A well finished operation can be made to look very well indeed if the screw heads are covered with inlays.

It has been suggested to wet the surface of the wood for the purpose of softening it, and then, with a thin flat chisel, cut a shaving about $\frac{1}{16}$ inch thick, $\frac{3}{4}$ inch long, allowing the end to adhere to the wood. Then wet still more or steam the shaving, so that it may be turned back; drill and insert a wood screw to hold the break together; bring the shaving over the screw head, glue and clamp it back in place. This remedy may be adapted to certain classes of cabinet or carpenter work, but in gun-stock repair it should not be used even in exceptional cases.

It may be desired, as an added feature of contrast or beauty, to have a buffalo horn, bakelite, ivory, maple or ebony fore-end tip. The material used is a matter of personal preference or expense. Buffalo horn is probably the most practical, however; many like contrasting wood, but in my opinion this is not an attractive addition to a rifle. If buffalo horn is chosen, cut it off to two inches in length and select a piece large enough so that its width will allow finishing squarely on both sides. Drill a $\frac{7}{16}$ -inch hole, $1\frac{1}{4}$ inches deep, in the center where the finished section will be below the barrels. Turn up a hickory or maple dowel $2\frac{1}{2}$ inches long, so it will enter the drilled hole snugly. Chuck a $\frac{1}{2}$ -inch piece of cold drawn steel and turn this down just so you can force the buffalo horn on. Allow the piece of steel to stand out from the lathe-chuck at least 2 inches when the buffalo horn is forced into position. With a side tool trim this off to a true face, which is then at right angles with the hole. Now cut off the fore-end squarely to the desired length, first squaring up the sides and top; then bore a $\frac{7}{16}$ -inch hole below the site of the channel about $2\frac{3}{4}$ inches deep. By means of the dowel adjust the horn tip to fore-end, using blue chalk to spot for perfect approximation.

Cut two pieces of $\frac{1}{16}$ -inch drill rod one inch in length and point one end. Then drill two $\frac{1}{16}$ -inch holes in buffalo horn in its upper portion equidistant from the dowel hole and well back; $\frac{1}{2}$ inch deep insert the two pins, which should enter the fore-end when in place. Spot with these two pin points and drill holes for them in the forearm. With the roughing or scoring tool shown in Figure 29 rough the face of both the wood and horn. Before gluing the latter into position, take

a three-square file and form a spiral from one end of the dowel to the other. It is now ready to glue in position, after wetting the surface of the wood with water glue made in the manner to be described.

Fill a small can cover half full of boiling water. With the glue brush, drop some of the hot glue into the water, making a thin mixture. Coat the surface of fore-end wood well with this solution, and let it thoroughly soak into the end grain for about ten minutes. At the end of this interval, apply the hot glue to buffalo horn, filling the hole, and drive in the dowel. Now run hot glue into the hole in the fore-end and also on the face of the buffalo horn. Drive into position and clamp, forcing the glue out from face of the horn and wood. Let stand for 24 hours, after which time it is solid enough to fit in the barrel. Figure 80 illustrates tips and suggestions for the student to follow out.

It is almost impossible to use wood chisels on the horn; therefore file out the channel with a 12-inch round file. Coat the barrel with lampblack and continue to remove the high spots until there is perfect contact. The fit should be tight enough to require a slight effort to force it and the fore-end apart.

If you should not have a lathe to face the buffalo horn, you must do this with a fine, broad, flat mill file, testing against an even surface; then drill the horn and bore the hole in the fore-end for the dowel. Fit horn and fore-end until no light can be seen between them. Never use lampblack or oil when fitting horn to wood, as this renders the glue inert.

Invariably imperfections make their appearance and must be corrected before they are too deeply involved. Inspect carefully the entire surface of the blank for any defects, such as "shakes," "dry rot," "knots," etc., which might extend deeper with still larger openings underneath. In certain instances these do not appear externally and show only when the stock is practically completed.

A "shake" is a small or large separation of the wood fibers caused by violent swaying of the tree and by bruising injuries sustained in the process of falling. It appears as a crack or split, almost anywhere on the surface of the stock, and may not be deeper than $\frac{1}{16}$ inch or may run completely through the blank, rendering it useless. The conventional method is to fill such "shakes" with shellac or other material; but this is not to be recommended, for eventually the original crack

will still remain, showing through the finish.

Dry rot occurs in woods which have been exposed to dampness or have remained in storage for a long time. It is rarely encountered in imported blanks, but is not at all uncommon in American walnut. Affected in this manner, any stock, be it domestic or foreign, is of no value unless the part involved is of such small size that it can be worked out.

.. Sporting Rifle Foreend Tips ..

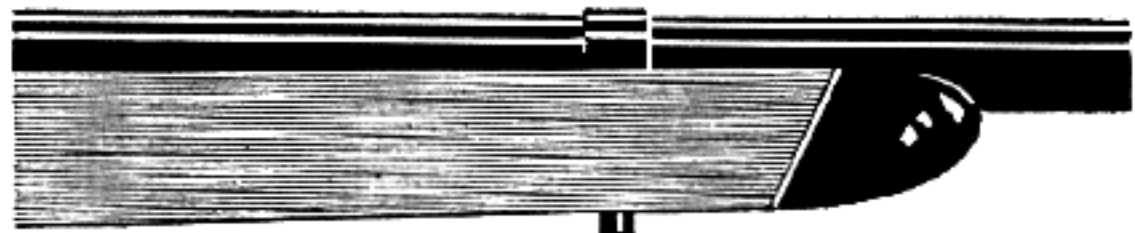

*African Buffalo Horn Foreend Tip
with Silver or Aluminum Inset*

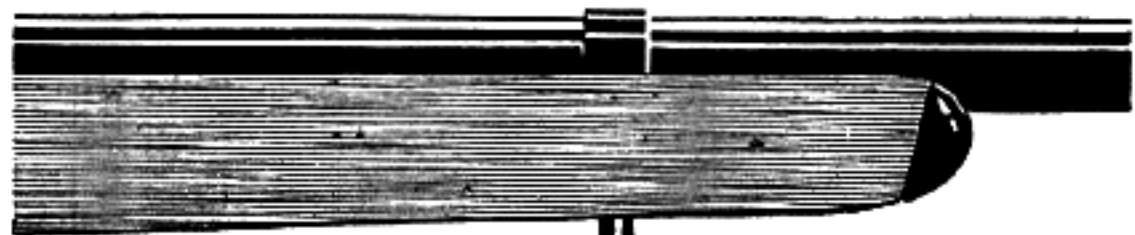

Bronze Foreend Tip

SANDBLASTED AND LACQUERED,

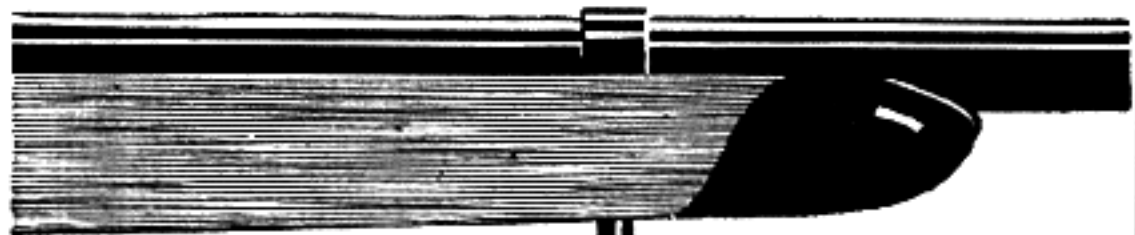

Bakelite Foreend Tip

DARK MOSS GREEN

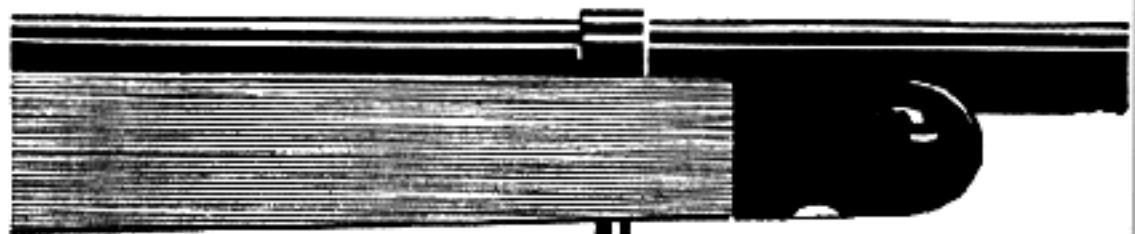

Bakelite Foreend Tip

TERRA COTTA RED . . IVORY INLAY . . .

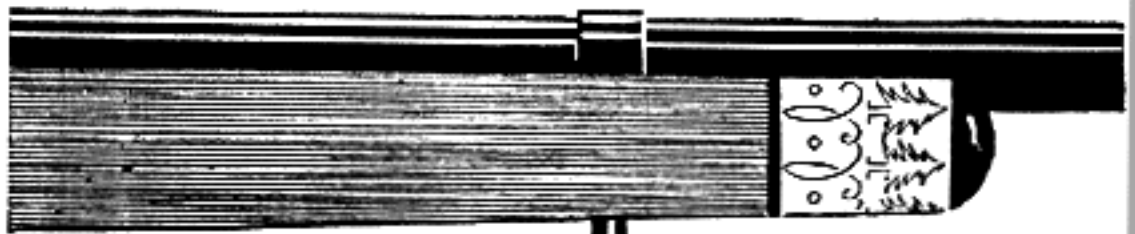

Carved Ivory and Horn Foreend

Fig. 80

Suggestions for the application of forearm tips to sporting arms

CHAPTER X

Modeling and Shaping the Stock

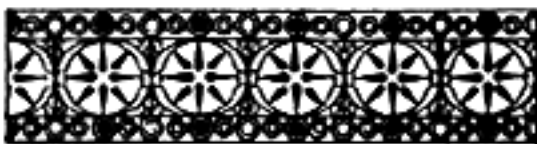

Modeling and Shaping the Stock

DURING the work described here, the chapter on design of stocks should be consulted frequently, for the two are closely interwoven. I shall presume that you have formed a mental picture of the ideal design for your stock. If this is done, half the battle is won, for you need only do as your ideas dictate, and you will find that these will in time unconsciously flow from mind to hands.

It is only possible for me to give stock measurements at certain points essential in the shaping of certain sections; for the rest, the human frame of the individual is the greatest figuration. Of the many stocks I have made for various men, no two have been alike. In general, the majority of men can be fitted with ready-made stocks just as well as with ready-to-wear clothes. We must remember, however, that most of these men wear these clothes only because they are less expensive and not because they give to the wearer that well-groomed appearance which creates self-assurance and poise. In the modeling of a stock, 20 per cent is actual measurement and the other 80 per cent is done with the eye.

When all metal parts are fitted into the blank, you will begin the actual measurements on the stock to fit the butt plate and pistol-grip cap. Chapter XIX, Volume II, contains correct measurements for a cap for a Springfield remodeled stock.

Figure 72 will give the reader a better idea of just what the stock should be, and the proper lines to form in the first stages of laying out the blank. First, we shall reduce the comb at *G* so the bolt will just clear. This is an established point, regardless of the drop from line of sights on Springfields, Krags, Mausers, Winchester M-54, etc. Adopt a measurement for the front sight, from center of bore. There are four different measurements: 1.1, 1.05, 0.925, 0.800. The 1.05 height is for the Lyman 48 and Pacific or Western aperture rear sights. The 0.925 height is for the Lyman No. 103 on the cocking piece, 0.15 lower than standard, or for leaf sights; and the 0.800 height is for the lowest possible leaf sights with a low setting of the front sight. The 1.1 height is for special target sights used in long-range work.

Figure 98, Volume II, gives the receiver and barrel gauge in corresponding figures, allowing

0.040 higher, made for the setting of the rear sight at 100 yards. This gauge is inserted in the bolt opening at the rear of receiver, and when in place it is brought up close to the bridge next to the point of the aperture sight, if one were in place. With these two gauges in position, Figure 72 can again be consulted. Place a straight-edge on top of them, long enough to reach from the front gauge over and beyond the butt. Be particular to see that the straight-edge lies along the top of the gauges touching at the muzzle and the top of the rear gauge. The next measurement is at *I* on the heel, which is termed the "drop" at heel or bend. This measures $2\frac{3}{4}$ to $3\frac{1}{2}$ inches, according to the requirements and build of the shooter. *A* is the length from the center of trigger to outer edge of butt plate. Here we refer to stock design, taking into consideration the anatomy of the person. This measurement may be from 13 to $15\frac{1}{2}$ inches. A short person may require the shortest measurement, while a very tall person might require the longest one. *M* is the distance from the end of receiver tang to the center of radius on the comb, while *F* is the distance from the center of the trigger to the edge of the comb. I never use the latter figure of measurement, for it varies on different rifles. *M* should measure between $2\frac{1}{4}$ and $2\frac{1}{2}$ inches, which brings the comb into the correct perspective to the other outlines and is at the same time in the required location. *B*, *C*, *D*, and *E* are the lay-out lines for the pistol grip. *B* is the height from edge of pistol grip to the comb, and *E* the distance from center of trigger to edge of pistol grip on *E*, *B*, and *C*. I am giving a maximum and minimum figure, and when laying out these dimensions on your blank, either use maximum or minimum figures. The first line which is laid out is *B*, and this measures between $3\frac{3}{4}$ and 4 inches. Carry this line forward and measure *E*, which is between 3 and $3\frac{1}{2}$ inches.

These two lines will intersect at the edge of the pistol grip. Then bring measurement *C* down, which is between $2\frac{3}{4}$ and 3 inches. *D* is a standard length of $1\frac{7}{8}$ inches for the pistol-grip cap. Carry this measurement back and have it intersect with *C*. When these lines are laid out you will get the distance *P*, which is the length

to the center of butt plate. Draw a line from *P* at the toe, intersecting lines *D* and *C*. Saw out this section from the edge of pistol grip to *C* and from *P* to the intersecting lines *D* and *C*, and fit the pistol-grip cap. The butt plate is also ready to fit. *J* and *K* are the distances from the center of trigger to the heel and toe—the line which governs the pitch. These two points cannot be measured with any degree of exactness, and the only reliable method is the one expressed in Chapter VIII. At this point remember to take into consideration the butt plate used, together with the build of the person, as described in the chapter on stock design. *H* is the measurement at the $\frac{2}{3}$ distance and is a matter of choice with the use of the gun; but if a cheek piece is to be considered, or even if it is to be omitted, it would be well to incorporate this feature when building a new stock, for it is very easy to remove it at the final finishing if it should not be wanted.

The cheek of the user of the rifle comes between *G* and *H*, whether a cheek piece or plain stock is intended; he always touches the stock at this point when bending his head forward to take the line of sight. This part of the stock should command particular attention. *O* is the circumference of the hand-hold or grip. This is measured with a tape and varies between $4\frac{5}{8}$ and $5\frac{1}{4}$ inches. A person must have his hand fitted to the grip where he feels the greatest degree of comfort. As stated before, particular attention must be given to that point regardless of any measurements, so that a gun will feel in perfect balance, or so that when it is brought to the shoulder the hand will have a perfect grip. *L* is the length from trigger to front sling-swivel through the forearm. Naturally this distance varies owing to the length of barrels which were described in stock design.

The next step is to fit the butt plate, after you have obtained the required pitch. Determine the proper cast-off, but first establish a true center line from the center of barrel to the butt stock, terminating at the heel and toe. There are two very reliable methods used to establish these lines. One is to take a $\frac{1}{4}$ -inch piece of drill rod 3 feet long which runs perfectly true. Turn up two brass bushings $\frac{1}{2}$ inch long and of the bore diameter. Sweat one of the bushings on one end of the rod and the other .2 inch from this and insert it into the bore of the barrel from the chamber end, allowing the rod to extend over the heel. Place a parallel over the butt stock at the heel, and with a square, just come up to the rod, first on one side and then on the other. Mark the point of contact on the wood so that there will be $\frac{1}{4}$ inch space between the marks. These two lines

are then divided and the true center is found.

The other method is to attach the sights. If a Lyman No. 48 is used, it must now be fitted into the wood. After the sight is attached to the receiver, place the barrel and action into the blank and mark the position where the wood must be cut out so the sight will be imbedded with a perfect fit on both sides and at the bottom. A fine-tooth hack-saw blade is the best to use to cut the section out, providing you do not have a fine-tooth tennon-saw. Keep away $\frac{1}{16}$ inch from the mark made and saw down into the wood about $\frac{5}{16}$ inch at the front and rear, and carefully remove the wood with a thin flat chisel. Place the barrel and receiver into position and trim down the sides until the sight base will enter the cut-out. Coat the sides and bottom of sight base with lampblack, and press into position. Remove wood very carefully until you come to the bearing of the receiver into the stock; then remove $\frac{1}{64}$ inch more wood at the bottom so that the base will be free and clear of wood. At the rear, also remove $\frac{1}{32}$ inch for a clearance so that if the action should ever set back from recoil, there will never be any danger of splitting the wood or loosening the sight.

Sight in the rifle for the desired range, usually 100 yards, using an old stock for this purpose. After the rifle is sighted in, you are ready to lay out the true center lines together with the correct height of drop at heel and the $\frac{2}{3}$ distance if the offset is to be used. If you have a surface plate large enough to make the set-up for laying out, well and good. If not, a glass surface plate as suggested, or a true-planed board without any warp will answer the purpose. Lay the rifle on the left side, and with parallels build up to a height that will be convenient to work from, using a surface gauge. First, establish a center on the end of the trigger guard, and with the surface gauge set this to the center of the small aperture. Then check to see if the center established on the trigger guard corresponds. If not, build up on that side until the center in the aperture corresponds with the center made on the guard. Line up the front sight to the center of the aperture, for the center of the front sight must correspond with the center made on the guard. With the rifle in position and the surface gauge set, scribe a line from the center of comb to the heel and from the heel to the toe. These lines will be the true center lines.

When this is completed, check for the correct drop from line of sight. Turn the rifle in a vertical position on parallels, and with the surface gauge again secure the center of the aperture and build up the muzzle until the center is in line with the top of the front sight. Having set the surface

gauge, bring it back to the heel and measure the distance, also at the $\frac{2}{3}$ distance, and as a future check, measure the distance at the comb.

After these lines are finished, determine the cast-off you will require and set it either to the right or left. Since you have studied the question of cast-off in design of stock, I shall presume that you have settled on what is needed.

Fitting the Butt Plate—There are four different types of butt plates; namely the rubber recoil pad, the buffalo-horn plate, the trap butt plate, and the steel-shotgun type of butt plate. The question of butt plates, or heel plates, in general is a matter of personal preference, and as they vary so, naturally the discussion is an open one, especially on shotguns. The fitting of butt or heel plates requires an explanation of the four different kinds which I have named.

Rubber Recoil Pads—There are two kinds of rubber recoil pads, which require two distinct ways of fitting. One is held to the stock by two screws. The other has a separate piece of rubber nailed to the butt end and is then cemented with rubber cement. The former is the most commonly used; the latter very seldom, except for a woman or a man who is extremely sensitive to recoil.

There are three different sizes of recoil pads; small, medium, and large. The selection of a recoil pad determines to a degree the weight the rifle will be when finished. The most satisfactory manner to place a recoil pad on a new stock, regardless of whether it is a rifle or shotgun, is to make a templet from $\frac{1}{16}$ -inch sheet brass, as Figure 68 illustrates. The size should be $1\frac{1}{16} \times 5\frac{1}{4}$ inches. The $1\frac{1}{16}$ dimension allows $\frac{1}{16}$ inch to finish on the sides or $\frac{1}{32}$ inch on each side of the stock. Since there is $\frac{1}{8}$ inch at toe and heel of pad there is $\frac{1}{16}$ inch for finishing at toe and heel to secure the proper length of plate or stock. The templet should be secured to the butt end of the stock by two brads or tacks and the wood roughed out to the templet. Having done so, fasten the recoil pad in place and finish the additional width and length during the final forming and sanding operations, so that it will come flush and even with the butt stock.

The fitting of a standard recoil pad, which is held by two screws, is quite an easy operation. First, the butt end of the stock is sawed off and finished to a perfect surface, still holding the lines established for cast-off, and allowance having been made for the thickness of recoil pad when the measurement *A* was secured.

The hard rubber face must be trued to a perfect surface; this is done on the face of the sander. If

the face is warped very badly, hold the pad on the ends, bringing pressure of the ends against the wheel. The heat generated from the friction of the sander against the hard rubber heats the rubber so that the warp comes back into position. The pressure applied will change the direction of the warp enough so that you will have a perfect true face. Use No. 0 sandpaper or finer on the face of the disc. With a piece of No. 2/0 sandpaper placed on a true surface such as a surface plate, complete the finishing of the face by hand-rubbing it back and forth over the sandpaper.

When the surfacing of stock and face of the recoil pad has been finished, place the pad in position on the end of the stock, and with a scribe mark off the position of the two holes on the center line thus established. Drill holes small enough so that the screw secures a perfect hold in the wood, and insert screws, using soap on the threads so that they will penetrate the wood easily.

The pad is now ready to sand down to shape. At this stage of the operation, it will be necessary to have a fast-running motor grinder, and two discs of hardwood (maple preferred) measuring 9 inches in diameter and 1 inch wide. The hole should be made to the exact size of the motor spindle. The Carborundum Company of America makes various grades of cutting abrasives formed on heavy paper discs which can be shellacked or glued to the face of the wooden disc thus made. If these cannot be procured locally you can take sheets of sandpaper and shellac these to the face of the disc, which will answer the purpose just as well. The grade of paper to use for sanding a rubber recoil pad is No. 1 garnet paper.

Sand the pad down to the edge of the wood in the manner described. Hold the stock in position, and work very carefully, keeping the surface parallel with the face of the disc; move the pad up and down so as not to cut too fast in any one place, for this will generate too much heat. Be very careful when working down the toe. Keep the direct angle of the bottom of the stock. Care must also be taken at the heel so that you do not undercut the wood too much at that point. It requires very steady holding of the stock to avoid cutting digs out of the wood, and also to prevent beveling the edges of the pad. The lines when finished should be continuations of the stock lines at all points.

To secure a fine finish at the last stages of the operation, apply a very light film of shellac to face of butt stock and pad.

The most satisfactory pads for rifles are the Silvers type, or such pads as the Jostam air cushion, Goodyear, or the Noshoc, which has a

brown finish. These pads are solid, without any holes on the sides to collect dirt.

A recoil pad should never be used on a low-power rifle except in rare cases where recoil affects the shooter because of some physical handicap, or for those who are prone to flinch—or to lengthen a stock. My advice to the student who is just starting out is to become hardened to recoil. A well formed shotgun-type butt plate made of steel is the best when it is well checkered. These should not be too deep, as on the Springfield service butt plate, but finely checkered, holding well to the clothing when placed against the shoulder.

Recoil pads are essential on shotguns which are made for trap shooting. They are also a necessity on heavy Magnum rifles, such as the .375, .404, .416, and .505, and on the heavy double rifles which are used mostly in Africa, India, and the Malays. Such rifles are fitted with the Silvers recoil pad, which is of British make. The Jostam air cushion is made on the same order as the Silvers pads, and is about equal in quality. All recoil pads deteriorate in time and become lifeless, especially the sponge-rubber pads. If it should be necessary to fit a sponge-rubber pad to a rifle or shotgun, even greater care must be exercised. First, peel the layer of soft rubber from the pad and tack it to the end of the butt stock. Be very careful not to come too close to the edge of the wood with the tacks. When you have a row of tacks all around the form of the butt stock, fill them in about $\frac{3}{8}$ inch apart; then cement the pad to the base which has just been tacked on. Any good rubber cement will answer. The pad is now sanded down by methods similar to those described for the solid rubber pad, but owing to the softness of the pad, you must always have a new piece of sandpaper glued or shellacked to the wooden disc; use only light pressure on the pad when forming it to shape.

Buffalo-Horn Butt Plates—The buffalo-horn butt plates come in three different thicknesses; standard is the proper size; it has the contour which fits the shoulder perfectly, and the face is indented with lines running crosswise. These plates are formed under hydraulic pressure, and when fitted properly the gun will have the finished look of shotguns of the better grade. I would suggest removing the cross lines and using, in place of them, a neat design of checkering on the face.

The standard buffalo-horn heel plate is about $\frac{1}{4}$ inch thick, the medium plate about $\frac{3}{8}$ inch, and the heavy plate about $\frac{3}{4}$ inch thick. The last two named are only used to extend the length of a stock. The standard is the one generally used and preferred. These plates are usually more or less

warped, and the stock must be formed up to the shape of the back of the plate. First, drill the two screw holes and countersink them for the intended screws. Figure 81 illustrates a brace countersink to use. A No. 8, $1\frac{1}{4}$ -inch standard wood screw

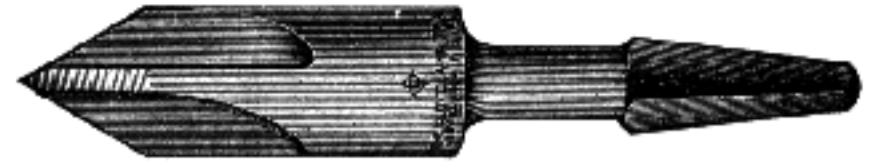

Fig. 81
Brace countersink. This tool is often required in inletting operations. Also to break the interior edges of rifling when a barrel is cut off

may be used. Tighten two larger screws on the countersunk side so that it will be possible to hold the plate while sanding, finish the back on the disc to hold the plate while sanding, and finish the back on the disc sander. Hold the plate very gently against the revolving disc, starting from the top of the plate and working down. Continue to do this until you have a bearing on the outer edge; then fit it to the butt of the stock. To get a perfect fit in the proper location, place blue chalk on the face of the plate. Work the wood off the high spots shown by the chalk with a flat wood chisel and a 12-inch half-round bastard file. Continue until you have a perfect contact between plate and wood. Then reestablish the center lines, if cast-off has been the requirement, and with a scriber mark the holes. Drill and screw the plate into position. The buffalo-horn plates are made oversize in width and length, and may be reduced at the heel if required; also the length is a matter of choice. After the stock is finished and ready to sand, bore out the butt for lightness and balance of stock, and then glue the plate into position. Let stand for 24 hours and complete the sanding of the stock.

Naturally a plate of this kind will not stand the hard use given to a rifle in the mountains, but for a man who is particular and uses a gun with great care, this horn butt plate makes a nice appearance. It is also very durable and stands shocks well.

Trap Butt Plate—There are four different styles of trap plates, of which the German plate is the best. This has an elongated hinged cover in the center of the plate. The Mannlicher-Schœnauer is also made on the same principle, but with more of a curve. The heel of the plate has a bad projection, its only objectionable feature. The English trap plate has the small round trap which only allows the carrying of jointed cleaning rods. Then we have the Springfield service butt plate with a round trap. This plate is often used in the remodeling of rifles into sporting arms, by cutting off

the tang at the heel, reversing the curve at the toe, and forming the plate into better outlines. It is then necessary to drill a new screw hole at the top above the trap to fasten in to the stock.

Naturally, when making up a new stock, you will want the finest trap butt plate, so you will choose the best, one of the German plates with the face well checkered, as illustrated in Figure 82, Number 2. The first thing is to remove the trap and spring by removing the spring screw. Place the tang center of the plate into position on the center line at the heel or the cast-off. Center should come in the center of screw holes in the plate. Mark the outlines of the tang and cut out for this in the wood, as part of the tang should come just below the surface of the wood at the heel. With a pencil, mark the outlines of the plate, and with a sharp chisel remove the wood at the outer edge, leaving the center high. Coat the under surface of the plate with lampblack and gradually remove the high spots until you have a perfect bearing all around and the edges of the plate set well into the wood. Sometimes you will find it convenient to use a wood rasp to remove some of the wood in the center of the butt. Use a wide, flat chisel which has a very slight curve; you will find this the most useful to obtain the perfect contact of the plate to the wood. Continue to let in the tang as you fit the plate in place, only removing the wood on the side bearings holding the bottom. The wood also must fit well up in the curve at the heel.

Having the plate fitted to the wood in a perfect contact and in position, mark the screw holes, drill for these, and screw the plate on with the slots of the screws in a north and south direction. Remove the plate, assemble the trap and spring, and cut out for the spring and screw. Remove the wood only where necessary so that the trap will open without binding. Lampblack placed on the spring and screw will show any binding points. With this completed, screw back on the stock and with a scribe mark the trap opening on the wood. When this is bored out, the stock is ready to be sanded down. The Mannlicher-Schoenauer butt plate is fitted in the same manner as the one just described, except that you will find with the Mannlicher plate the screw at the heel is set in at a greater angle than on the German type of plate. In the Mannlicher plate, the heel screw will draw the tang down very tightly into the wood. If the regular screws should be missing you can use the ordinary wood screws with the countersunk heads. When fitting such screws as these, have the heads a little larger than the size of the countersink, so it will be possible to round the edge slightly, and also have the

slots of the screws in line with each other; which is called in gun work "north and south." This shows better in the finished appearance of a good gun, and at the same time expresses good taste and careful workmanship. If it is desired that the screw heads be finished, information on the operation may be found in Chapter XXII.

After fitting the plate, check for the pitch. One of the most accurate methods for this is to take a piece of $\frac{3}{32}$ x 1 inch cold drawn steel which is perfectly straight and screw it to the long blade of a carpenter's try-square, having it extend out perfectly straight from the blade. To test for the pitch, hold the square in the center of the butt plate and also in the center of the rear aperture. The pitch will be the distance from the end of the long blade to the tip of the front sight. The simplest method is to place the butt of the gun on the floor with the rear sight touching any square upright, like a door frame; the distance from the front sight to the square upright will also indicate the pitch of the butt.

If the pitch is to be straight, it will be necessary to remove the butt plate and cut down the toe of the stock so that the plate will be set in at this point a little deeper until the required pitch is obtained. If less pitch is desired, set the plate in at the heel. During all the stages of fitting the butt plate, the distance from center of trigger to outer edge of plate should be carefully checked to see that the desired stock length is maintained.

Plain Steel Shotgun Type of Butt Plate —

The trap butt plate and this type are very similar, except that this does not have a trap. It is also fitted to the stock in the same manner as the trap plate. These plates come checkered and plain; the plain plates are matted, as described in Chapter XXII. These plates may be engraved very artistically and are a credit to any well-made stock.

All butt plates when fitted must be filed flush with the stock on the final finishing operation. Allow the edge of the plate to show with the small angle which is turned in toward the stock. This is a point which many overlook, no doubt because of the smallness of the detail. File all plates, with the exception of the two last named, so that steel and wood are one continuous line. This is done on the final filing operation before sandpaper is used; the later use of the different grades helps to polish the edge, giving a finish to the metal.

I have named four different kinds of butt plates which, in my opinion, should become standard on all rifles. At times the beginner will not be able to secure the plates I have named, so he must make his own plates. This information is given in Chap-

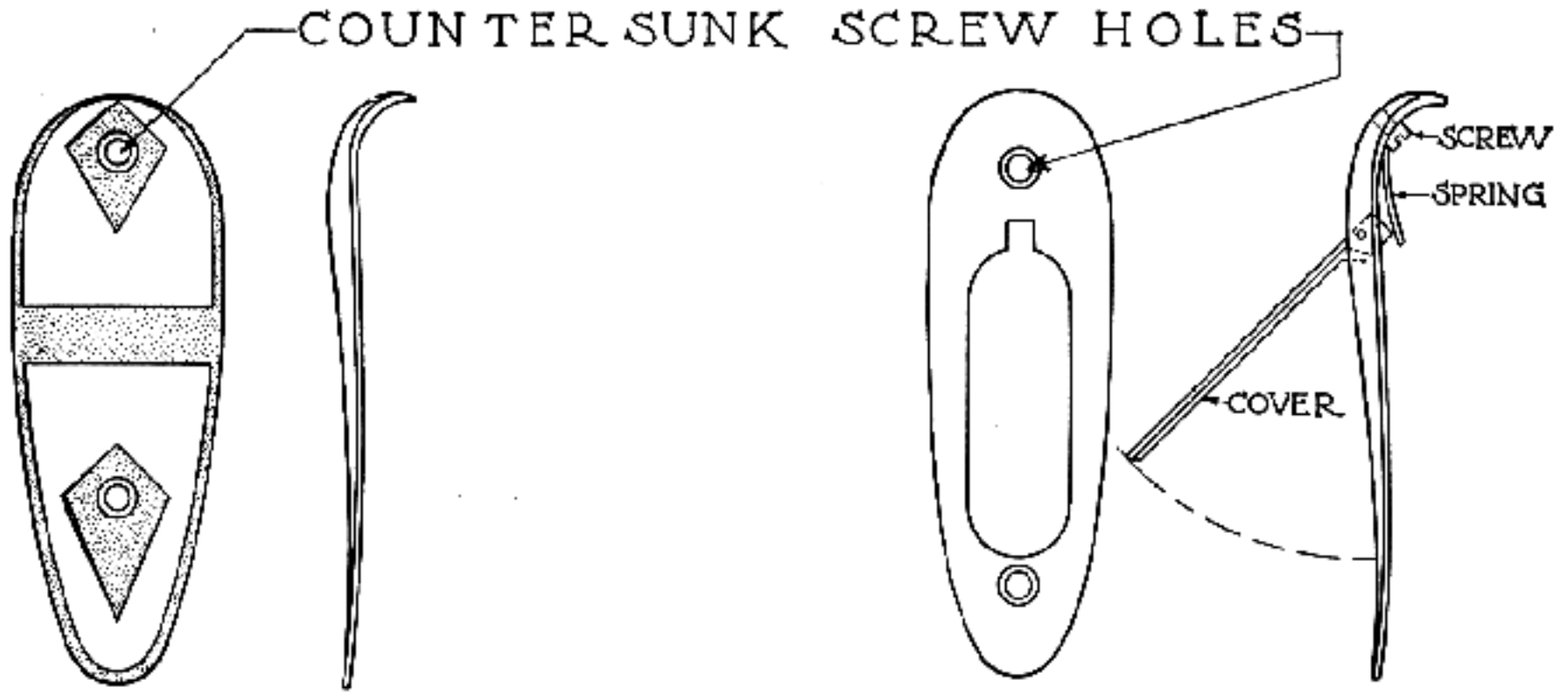

NO 1 BUTT PLATE
PLAIN ENGRAVED STEEL

NO 2 TRAP BUTT PLATE
ORNAMENTAL ENGRAVED STEEL

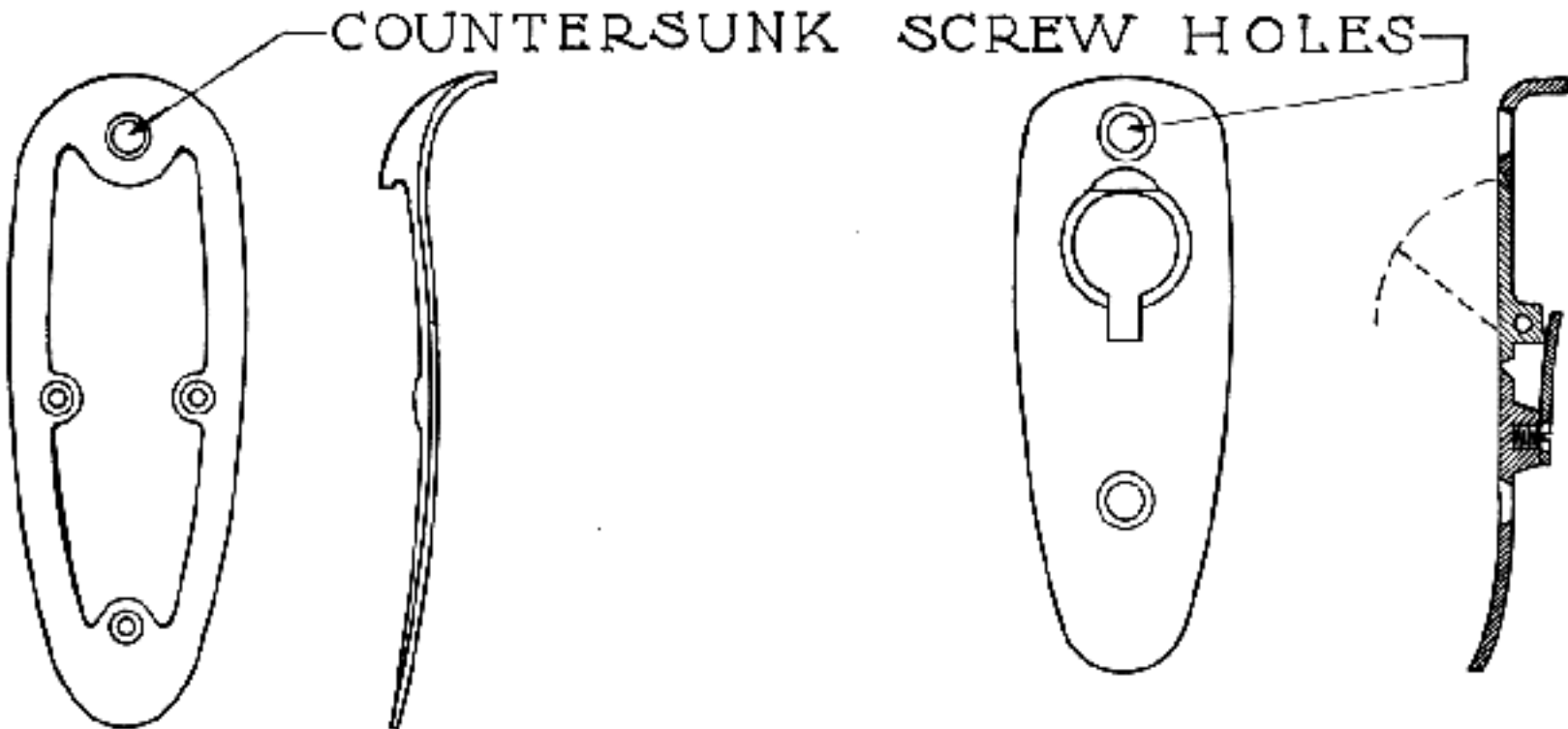

NO 3 SKELETON BUTT PLATE
ORNAMENTAL ENGRAVED STEEL

NO 4 SPRINGFIELD BUTT PLATE
RUST PROOF STEEL

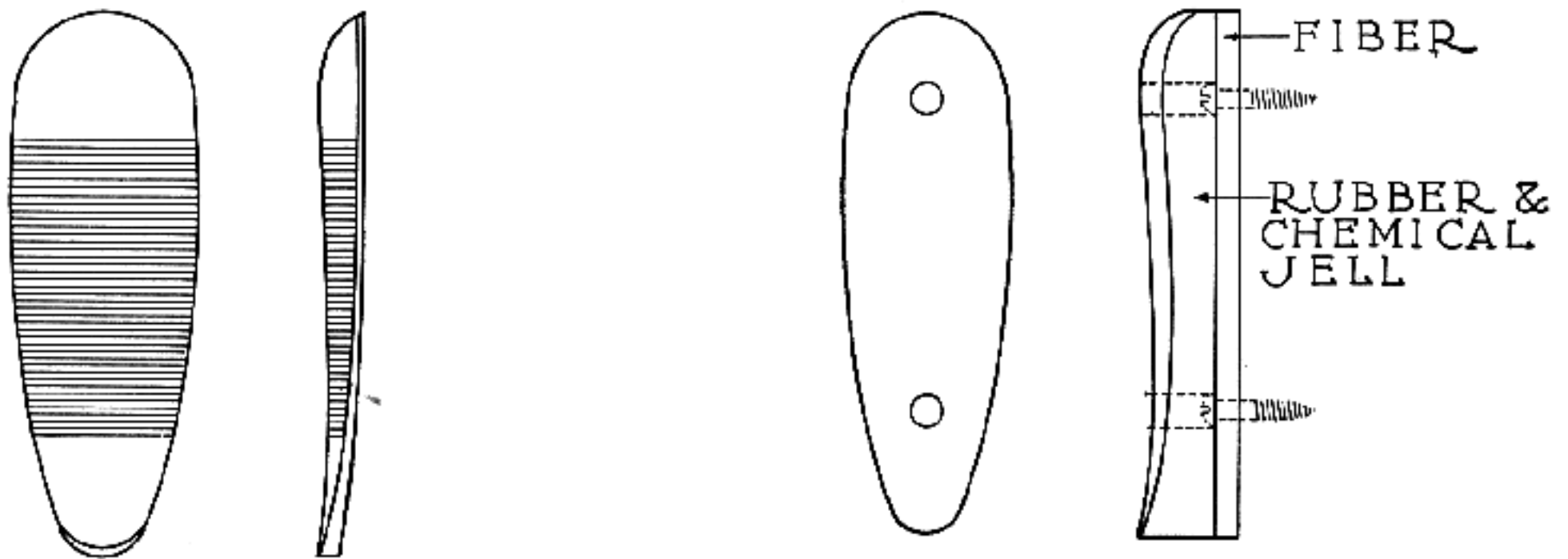

NO 5 RIBBED BUTT PLATE
POLISHED BUFFALO HORN

NO 6 NOSHOC RECOIL PAD
FIBER AND RUBBER MOULDED FINISH

Fig. 82
Types of butt plates used on rifles and shotguns

ter XIX, Volume II. Or he may wish to use some material such as fiber, copper, silver, aluminum, or brass. Of course, these are only a matter of personal preference with the beginner, but sooner or later he will realize the advantages of these standard butt plates.

Boring Out the Butt Stock—The boring out of a butt stock should be done after the stock is all shaped up, ready to sand. Sometimes it is desired to bore out the butt for cleaning rods, spare parts, cleaning patches, etc., when a trap butt plate is used. If only for bringing the stock into better balance, the recess must be sealed by gluing a block into the cut-out made, to prevent moisture from penetrating into the holes under the butt plate and causing the stock to swell. The trap plate, when fitted, was scribed to the outlines of trap. Lay this out for three $\frac{7}{8}$ -inch holes which will just touch each other in the scribed outlines of the trap. Bore these three holes in the stock 3 inches in depth. Hold the stock very firmly between padded jaws in the vise, and bore the holes on a straight line, with the exception of the lower hole which must be on a slight angle or near the angle of the bottom of the stock. Remove the side walls with a thin wide chisel to the 3-inch depth, and with an $1\frac{1}{16}$ -inch or $\frac{3}{4}$ -inch bit, bore to any desired depth on the top hole. The center hole may be bored with a $\frac{9}{16}$ -inch or $\frac{5}{8}$ -inch bit on an angle to meet the top hole. The bottom hole may then be bored to the full depth of the bit, or to meet the center hole. This hole is bored on a sharper angle in order to stay away from the bottom angle of the stock. Great care must be used when boring these holes in the butt stock so that they will not come out on the side; do not use too large a bit. Measure the thickness of stock before starting, to see how much wood there is, so you can gauge the size bit to use, and above all, keep the bit in the center, using your eye to keep it in line and also at the right angle.

If you do very many of such operations, you are bound to have the disagreeable experience of having a bit come out on the side. I have had it happen a few times; once on a very expensive Circassian walnut blank, and another time on a cheaper one. You may well imagine how discouraging it is to have this happen after you have taken such pains to bring the stock to its nearly finished condition.

If this misfortune should occur, turn a walnut plug the diameter of the bit, or about .010 inch undersize, and 2 inches long. Glue it in place, setting it firmly in the bottom of the hole, and let it stand for 24 hours. At the point where the bit came

out, drill and counterbore and set an inlay in place, either of ebony, buffalo horn or fiber, laying the inlay large enough to cover the broken fiber of the wood. Sometimes a round inlay cannot be used, if a very large section has been broken out. It will then be necessary to make an inlay of an odd form, such as a diamond, oval, square shield, or to follow the natural grain of the wood as described in Chapter XIII. Glue these in place and finish to the surface of the wood. These you may call marks of distinction, which are really marks of carelessness.

Roughing Out—Complete all the work of fitting the butt plate, pistol-grip cap, horn fore-end tip, height of comb and heel at the required drop and the $\frac{2}{3}$ distance which is left higher for the final fitting for drop, together with the outlines for the cheek piece. You are now ready to rough out the stock and form it into shape. A considerable part of the roughing-out process may be done with a wheelwright's draw-knife. The usual care must be given to all cuts.

Having assembled the rifle, hold it in the vise in the most convenient position between the felt jaws, with the butt end resting on the gun brace. Figure 29 will give the correct dimensions for the construction of one of these, which should be covered with soft leather. It is made from a $2\frac{1}{4}$ -inch plank of hard wood, the upper edge at a height which will be about $1\frac{1}{4}$ to $1\frac{1}{2}$ inch less than the height of the vise jaws. It is pivoted with a single $\frac{3}{8}$ or $\frac{1}{2}$ -inch screw, passing through the bottom side or extension. A hole is bored in the bench, so the brace will extend well over it. A bolt with a wing nut is used, and tightened so that the brace will turn freely. It can be swung around to the back of the bench when not in use, and when needed it may be turned in front and is ready to support a stock or barrel when clamped in the vise. The brace is generally put on the right-hand side of the vise, but you can bore a hole on the left-hand side also when the extension calls for its use on that side, and it will be wise to make two, as this saves a lot of time changing from right to left.

When cutting out stock from the plank, many times pieces of just the right size for these braces will be formed among the cuttings. The shape is of very little importance, as long as they are of the proper height and have the extension long enough to bolt the end to the bench.

It is better to start on the right side of the butt stock to begin the roughing operation, for here you have a straight form to work to. Rough this out, using the draw-knife, plane and spoke-shave. The largest amount of wood will be removed with the

draw-knife. Be careful to cut against the grain of the wood, and use only short strokes in an upward direction, removing short chips from the wood. When cut down to within a reasonable distance of the outlines of the butt plate, bring the plane into use and remove the high spots left by the draw-knife. Finish with the spoke-shave to bring the lines out straight.

Remove the rifle from the vise and clamp it at the butt stock with the magazine up and the barrel resting on the gun brace. With a short butt chisel, remove the heavy wood from the contour of the pistol grip, reversing the chisel so it will not dig in too deep. Be very careful when removing this wood so that you do not open up the grain. From this point to the pistol-grip cap, use a rasp on both sides. The surplus may be removed with a thin flat chisel, using hand pressure to remove the wood; also use the spoke-shave to bring it near to form.

Reclamp the stock sideways at the receiver and guard with the end of the fore-end resting on the wood near the tip. Start shaping the fore-end back to the grip, using the draw-knife, plane and spoke-shave. When a large piece of buffalo horn is used for the forearm tip, use a hack-saw to remove the surplus amount from the sides, keeping away from the barrel at least $\frac{3}{8}$ inch or a distance which will finish up to the correct form. Also saw off the bottom on an angle from the front to the back, and leave a measurement of at least $1\frac{1}{4}$ inches at the point of contact. Then saw off the corners of the square that is made so that the horn can be filed up with the least amount of effort. Figure 71 shows the tip thus formed.

Continue to remove the wood on both sides, and the bottom of forearm, down to the horn tip, and with a 10-inch bastard file form the tip to the required shape. Be careful not to touch the barrel with the file, or the horn with any of the edge tools used to form the sides back to the pistol grip and from the bottom to the guard. Here is where your eye is the best judge in the final shaping to form. The sides of the action must be rounded in effect, from the action to the guard, with all lines blending into each other. The lines begin to take form from the back end of the magazine to the contour of the pistol grip, and also at the top, at the beginning of the tang of the receiver to the comb. All lines continue to blend harmoniously, your eye being the only judge. The technical worker, when he begins to form one of these stocks at this point, will ask why a series of templets could not be designed to give all such measurements. True, they could, but only through great expense; thus we must pass out of the mechanical stages of such opera-

tions and train the eye to do the work of templets.

You have probably begun to notice how the stock is shaping to the desired form, but still the wood remains on the left side for the *cheek piece*. Study the different photographs and drawings throughout the books, and with these before you, turn to one of the well designed cheek pieces shown. Picture the same form on your own stock, which is now only a block. Figures 72 and 84 will give the correct ideas to lay this out, together with the correct radius to use. Yet, with all this, you can take a lead pencil and lay these out just as well. I shall presume that you have the cheek piece laid out on your stock, with the receiver and guard clamped between the felt jaws of the vise and left side resting on the gun brace. With a $\frac{1}{2}$ -inch flat-butt chisel, cut well around the form into the lines thus made. With a 1-inch flat-butt chisel and a small mallet, cut out the wood from the butt plate to the cheek rest, down along the sides and well along the grip to the comb. After the wood is removed, the form appears rather pronounced. With a wood rasp, you can remove the high points near to the form of the butt plate, and with a $\frac{3}{4}$ -inch gouge, or smaller, begin to form up the outside bead, all around the outlines, staying well away from the bottom $\frac{1}{8}$ inch. With a spoke-shave or draw-knife, proceed to remove some of the surplus wood on the cheek piece proper until you see the rest taking the form you have pictured. After fitting it to your face, continue to form the bead with the round gouges. Reduce the wood all around it with a rasp and a bastard file, which are the only tools that can be used on this side of the stock. You will also form up the slope from the Monte Carlo effect to the heel, and carry these lines out very gracefully.

At this stage you are able to determine whether or not the stock has the correct drop at the $\frac{2}{3}$ distance by bringing the rifle up to your shoulder and aiming at an object in the manner described in Chapter VIII. If the offset is too high, remove some of the surplus height from the $\frac{2}{3}$ distance up to the comb, being careful not to remove any wood at that point. Reshape the cheek piece at the proper form on top and again try the rifle to your shoulder. You may find now that you have the height about right, or you may find that it is still necessary to remove more wood, until you have very little of the original height left at the $\frac{2}{3}$ distance. Some require more height than others, and some none whatever. This I can only leave to your best judgment.

Following the roughing-out of the stock, the final shaping is to be done. Actually it does not matter where you begin, for at this stage you must jump from one place to another; harmonious lines are the

object, and a little removed at one point requires the removal of a small amount at another, just as an artist would do when completing a picture. Without any particular point in view, it will be well to work on the pistol grip and comb. The distance of $2\frac{1}{4}$ to $2\frac{1}{2}$ inches from the end of the tang to the comb is well roughed out, and also the form of the pistol grip to the form of the cap. With the spoke-shave and a half-round bastard file, bring all these lines well into form; also back of the grip cap, leaving the under-line form up a short distance into the grip proper, then ending and blending into the sides and grip. File out the curve of the grip from the end of the guard to the edge of the cap. To complete the form of the lines running into the grip, it will be necessary to remove the guard and with a spoke-shave work down the wood. Start from the magazine opening back to the grip and up to the edge of the trigger guard, before the guard is removed. With a thin flat chisel, remove all wood that projects above the trigger guard as it continues back to the end. With the spoke-shave, trim the wood right up to the tang so it has only a light rounded edge left. The butt stock is clamped between the felt jaws for this operation while the action is being removed from the stock.

With the spoke-shave round up the edge of the stock on the left side of the action, along the top of the barrel opening on both sides up to the fore-end tip. Also file this to blend in with the lines thus made. While the barrel and action are removed, touch up all points that you see and cannot work on while the barrel and action are together. When all is completed, assemble the parts again and continue on some other part of the stock, say, the fore-end and the sides. All the final finishing at these points is done with a spoke-shave and a 10 or 12 inch mill file. Have the sides of the magazine and forward end of the guard come flush with the wood, carrying all these lines well out to the fore-end tip and the sides, which must have a rounded effect from the bridge of receiver to the rear of the magazine opening. These lines are then carried well into the fore-end and pistol grip. Having gone as far as you think best on this part, start on the right side of the stock and finish it up to the grip and a portion of the under side.

At this stage begin the undercuts at the comb, removing the wood so that lines will begin to blend into the grip. Use a round curving chisel to remove the wood at the comb in order to obtain a well rounded effect near the top of the comb. While doing all this work, always retain a pencil center line on the top. If you do not, you are likely to carry the comb too far to the left. The finishing to lines is done with a spoke-shave and a 12-inch mill

file. Check often to see that you keep a straight line from the butt plate to the pistol grip, using either a 12-inch scale or a straight-edge. There is always a tendency to leave the center high, so remember that this must be a straight tapered line. The spoke-shave is used to remove the surplus wood, and the file to straighten out the grooves left by the spoke-shave.

Next comes the final shaping of the cheek piece, and the forming of the stock around it. Most of this work should be done with a flat bastard and a mill file, with the round gouges for the radius on the ends. You will notice a square edge from the stock to the radius of the bead, which is a rise of $\frac{1}{8}$ inch; then the radius starts from this edge. This part is filed in with a mill file and also a smooth-edged pillar file. After the radius is completed with a neat inward curve with the round gouges, the final finish is obtained with a round file equal to the radius. The square edge blends well into the comb, and the bead forms the undercut at that point, as you continue to the back with the bead and square edge. This curved radius gradually narrows at the top until it finally blends ahead of the $\frac{2}{3}$ distance and dies out.

While this is being done, the curve of the cheek is also worked out until a perfect rest is made for the face. When working on the cheek piece, bring it to the face often in the shooting position to see just how it feels. Test for circumference of the grip to see if it fits the hand perfectly, and also the rounding of the comb. All these parts must be in perfect balance for good handling of the rifle.

When shaping the wood flush with the tang of the receiver, use a small bastard file and exercise the greatest of care. File away from the wood on each side, until it just comes flush. Always file in the direction of the action so that there will be no danger of pulling out a splinter of wood. As this is filed, carry the lines well into the comb and grip, using a small half-round bastard file. This type of file is also used to file the undercut of the comb, after the wood has been removed from that point with a round gouge.

I find it difficult to explain the methods of giving the final form to the comb. Study all photographs in this book, and also as many different stocks as may fall into your hands, then work out one you think correct and work as near to it as you can.

At the final shaping you may finish the pistol-grip cap or make a templet as shown in Figure 68, bringing the wood flush with the edges. If you have followed directions when you fitted the cap, you filed the under side to a perfect surface and also the face of the wood. You have the screw in the proper position with the slot facing north and

south. Assuming that all this has been done, you may now glue the cap in position before any further work is done and allow the glue to dry thoroughly. Then finish the cap to the desired shape. Proceed to file the grip down flush with the edges of the wood, holding the correct form. Study it frequently from the sides and top to see that you are holding a symmetrical form, not only to the cap but in the rear of the cap and the bottom side until your final lines blend into the stock proper and disappear into the form of the pistol grip.

In this work you have used quite a few files to obtain a true and even surface. In order to do the best work, the files must be sharp. A dull and worn file causes an uneven surface on the wood, for all wood has hard and soft spots; a dull file will not remove the hard spots but slide over these places and remove the soft spots, causing unevenness and a ridged surface. If there is a good deal of wood to remove with a file, you may use a certain amount of pressure; otherwise, use it very lightly to remove the marks of the spoke-shave or rasp. Always use the file across the grain. It will more or less shed the wood, leaving deep file marks which must be removed.

The work you have completed is now ready to be sanded to obtain the desired finishes. At this stage you may complete the boring of the butt stock to bring the rifle into proper balance; this operation has already been described. If a buffalo-horn butt plate is being used, after boring out the stock, this may be glued in place and allowed to stand for 24 hours. The sanding and finishing are described later and in Chapter XII.

If there are any small imperfections to be doctored up, this operation should be done previous to the sanding or final finishing. At times such things as knot-holes may not present themselves until the stock is nearly completed. The very small centers in the knots may be drilled out, using a drill just large enough to remove the small eye. Turn up a piece of buffalo horn and glue this in, or if you lean toward the eccentric, ivory plugs create an unique appearance. If a knot-hole opens up very large, it may be best to drill out the knot and insert a piece of walnut with the grain running lengthwise. Coat the plug thus made with glue, and drive it into place, letting it stand for at least 24 hours before it is cut down flush with the stock. After all the defects have been repaired or removed, you may continue with the sanding operation.

Not everyone wishes to have a cheek piece or a buffalo-horn fore-end tip, or even a pistol grip. Naturally, taste varies and requirements differ greatly. One may wish the fore-end shaped up with a schnabel; the next may only wish it running up

to a point, while others may prefer the plain British style. A cheek piece is required for some men who are thin-faced, but not for full-faced men. Some may only wish the plain flat cheek piece found on the standard European arms, while others wish a particular rest of their own design. Nearly every one requires a pistol grip.

A stock with the cheek piece, buffalo-horn tip, and Monte Carlo effect at the $\frac{2}{3}$ distance is one of the most difficult stocks to turn out. The experience the student will gain by working on the hardest form of stock will stand him well for the simple design, such as the plain stock with cheek rest and only a schnabel on the fore-end, which you have experimented with in Chapter VIII, together with the experience acquired with the comb undercuts. Whatever form of stock you have made, it should fit exactly right when it is brought to the shooting position. It would be well to give it a trial on the range before you begin the sanding operation. After trying it in all positions in which you may use the rifle, you may find some minor changes necessary. The comb or cheek piece may not be formed just right. The pistol grip may not have the proper curve. You may also find the fore-end a little too full; it may be reduced. In fact, you will have a number of slight changes to make, for the range test really shows up more than any other form of trial in the shop.

Shotgun Stocks — The forming of a shotgun stock is a very easy matter compared to the inletting of the action. The work on the exterior of the stock is similar to that of a rifle, except that you have a more dainty and slender stock to form up, which must be very graceful when completed.

Place a straight-edge over the rib, which has an opening for the front sight, at the same time allowing it to rest at the rear on the top of the rib. You have used the straight-edge on the rifle over the front sight, and at the center of the rear sight. It is done in the same manner on a shotgun which is over the sighting plain, or over the rib as on the Cashmore, or any other double shotgun. Figure 72 will give you a much better idea of the principal layout lines, while Figure 67 gives dimensions. *C* is the length from the center of front trigger to the center or outer edge of butt plate. This measurement may be between $13\frac{1}{2}$ and 15 inches. *N* is the distance from the end of the stock, fitting against the action. This measurement varies so greatly on the different makes of arms that no length can be given for new measurements; it is only used as a check to make a new stock for the same action. *J* is also a measurement which can-

not be given for the same reason. Still it is a convenient means of checking.

It will be far better to bring the point of the comb into proper perspective to the other lines, and at the same time in the location which will fit the hand comfortably. *H*, *I*, *F*, and *G* are the layout lines for the pistol grip. *F* is the distance from trigger to edge of pistol grip. *H* and *I* vary greatly on different forms of actions, so these figures can only be used as an approximate measurement for the average. *A* is controlled by line of sight and drop at comb, while *I* is a figure we can use but should not be governed by; it is about 3 inches or less. *H* may be used as a given maximum or minimum figure, which is between $2\frac{3}{4}$ and 3 inches. *G* is the length of the pistol-grip cap, which is between $\frac{7}{8}$ and $1\frac{1}{8}$ inches wide. This is connected to *H*, forming the angle of the pistol grip. Having these lines laid out, you will now secure the distance *K*, which is the butt plate to be used. Then draw a line from *K* at the toe, intersecting lines *H* and *G* providing these lines are laid out to the correct measurements which will come well in line and well in proportion. You may now saw this section out, together with the pistol grip. This is from *G* to *H* and from *K* to *H*. You may now fit the pistol-grip cap. The stock having been cut to length, the butt plate is also ready to fit. *E* and *D* are the distances from the center of front trigger to heel and toe. These measurements govern the pitch. These two lengths cannot be measured, as explained in the Springfield measurements, but are so placed that a dimension can be given when future stocks are made. *L* is the measurement at the top of the $\frac{2}{3}$ distance. This is a matter of choice with the student. *A* is the drop at comb, which measures $1\frac{3}{8}$ to $1\frac{5}{8}$ inches in this day of straight stocks.

In a new stock the $\frac{2}{3}$ distance or the top of the Monte Carlo effect is generally left $1\frac{3}{4}$ to 2 inches in height and removed when not required, after you have tested the gun in the shooting position. You may only have a small indication of this left when you have found that the full height is not desired. *M* is the circumference of the pistol grip. This measurement also varies on shotguns the same as on rifles, and no set rule can be given, for the reason that we have the light and heavy gun, and the only reliable method is to fit your hand around the grip. For a normal hand, the circumference of a grip should be between $4\frac{1}{2}$ and $4\frac{3}{4}$ inches. This measurement is for a 12-gauge arm. Naturally we have the small bores such as the 20, 28, and 410 gauges, and some of these light guns are rather delicate in the grip. As hands differ, we must construct grips which will fit comfortably and still hold to the racy outlines desired.

The exterior of a shotgun stock is roughed down as on the Springfield, except that you have a daintier stock to work on, which is only held to the action by two small screws without the support that a bolt action would have. Consequently, you must exercise greater care and not put undue pressure on the wood to remove the chips, for you can only hold the small part of the action between the felt jaws in the vise with the butt end resting on the gun braces.

The fitting of the butt plates is the same on a shotgun as on a rifle, so we will assume that you have completed all of this part and carried out the other requirements such as pitch and cast-off. The latter shotgun problem has been an open discussion for a long time on this side of the Atlantic, no doubt because of the fact that all shooters do not know how much this affects shooting for better results. Nearly all factory arms are minus cast-off and the American shooter has become so accustomed to it that he finds it difficult to change. When a stranger comes into my shop, and puts an arm to his shoulder that has all the proper measurements, he invariably asks me what I have done to the gun to make it fit so comfortably. Then I explain all these essential points to him and he rarely is satisfied until he has a gun made to fit his exact measurements.

Roughing — On a straight stock without cheek piece, such as designed for the Cashmore, the wood may be reduced greatly with a plane and a spokeshave, also a small cabinet rasp and 8-inch half-round bastard file. Be careful at this point that you do not allow a file or chisel to hit the metal parts, for this will leave bad scratches or file marks on the action or guard. The comb must be worked in as you shape around the pistol grip. There are no particular tasks from now on, for you are moving from one point to another, using your eye, which is your best guide when the stock begins to take form. The stock is continually taking form until you have reduced the wood flush with the butt plate. On the Cashmore, I have used a buffalo-horn heel plate, and before setting it in place I have reduced it to $1\frac{5}{8}$ inches wide and $5\frac{1}{8}$ inches long, removing most of the material at the heel to secure this length. I have left the center high, making a very convex surface, and after complete polishing I have placed a very neat checkering design on the face, for buffalo horn takes checkering readily and gives a very artistic touch to the finish of the heel plate.

You have probably had difficulty in forming up the pistol grip, but if you will bring the lines out in the best perspective—by forming the buffalo-horn cap to a complete oval on top, down to within $\frac{1}{16}$

inch of the edge, and then letting your lines blend out into the pistol grip proper—you will have solved a part of this problem. Many amateurs make the mistake of placing odd forms on the caps, breaking the lines and not blending in well with the form of the grip. Also they often place a thick flat cap on the grip. By all means try to keep the cap formed to an oval if possible, so that when you place the arm in your gun cabinet the grip cap with a discrepant design will not be staring you in the face. Let the wood run out straight from the sides of the action, so that it will be possible to form the side panels on the finishing operation. Let the comb be well rounded and form the step-off to heel at the $\frac{2}{3}$ distance. The finish will only be a matter of reducing the wood to secure the correct drop at this point when the weapon is tried out for height of drop.

The finishing of the stock is done with a spokeshave, a flat bastard file, a mill file, and a small half-round file for the side panels. First secure the correct form of the panel with a round carving chisel. Reduce the $\frac{2}{3}$ distance and round the comb so that you can try the gun to your shoulder. Keep reducing this part until you have a drop that comes up with perfect ease and comfort.

Test the gun in the field under actual shooting conditions to see if the results are the same you experienced in the shop when you tested it to your shoulder. The actual shooting will prove to you four points: drop, length, pitch, and cast-off. The last cannot be changed, but the drop, length, and pitch can; do this now. Length may be reduced, but not added to, except with a foreign addition. Pitch may be easily taken care of by reducing the heel or the toe. Drop is only a matter of reducing the distance at the comb and $\frac{2}{3}$ point. Another trial in the field should be given to see what difference has been made, and after that is done you will be prepared to make the finishing touches.

It will be best to begin at the side panels. First study a sample stock, and then finish the stock flush with the action so that this will be one continuous line. If you do not feel confidence enough in your artistic ability to lay off the point of the panel with a lead pencil and scale, lay it out on the drafting board, and with shears cut it out to the lines. Lay the paper on the side and mark out with a lead pencil; then reverse the paper and lay the opposite side out. With these lines in the correct position, take the small carving chisel and form the radius. If you should wish the small continuation of the design which is placed in the back of the large panel at the point, carve this out, keeping the bottom edges sharp. I always place a radius around the edge of the panel at the point, instead of the small

design, for when you carry out the radius to a sharp point, it will leave a slight rise back from the point and will die out in the grip. You may then have well blended lines, but when you place the very small panel back of the point, this will break them most unattractively. Most British shotguns have had this added panel for a long time. Of course, many like such additions, but there are a thousand and one ideals of beauty. Continue to finish the pistol grip, and have all the wood come flush with tang of action, trigger plate, and guard. Give the comb the final finish and then complete the sides, comb to heel and underside lines. Most of this work is done with the mill file. Have the wood and heel plate come flush. When all is completed, remove the butt plate and bore for the correct balance, which can only be determined by "feel." Glue the butt plate on and let stand for 24 hours. The stock is then ready to sand, which will be explained later in this chapter.

Having completed a rifle and shotgun stock, you may apply similar methods to all other stocks. Some double guns have the side plates. These are finished in the same manner; there is only a little difference in the forming of the wood around the plates. A straight hand stock is far easier to make than the pistol-grip stock. It really makes little difference to the beginner when he has the general principles of the exterior forming or modeling of a stock whether it is a two-piece stock or a rifle. The general principles are the same. You may require a slightly different design or you may wish an odd design. This is entirely up to you, and I will let you work out your own problems, for if I went on and placed before you the many odd ideas which I have incorporated in stocks to suit individual requirements, this chapter would be out of all proportion to the rest of the work. You are well prepared to form a mental picture of just what you wish and to carry it out to your own expression.

To place the final finish on the surface of the wood, you must go over it with sandpaper. Use No. 1 garnet paper for the roughing, and for the final finishing use No. 7/0, which is the finest sandpaper made. With a wet cloth, thoroughly wet the entire exterior surface of the stock, causing the grain of the wood to rise and the surface of the wood to appear very splintery. Allow the stock to dry naturally. With No. 3/0 steel wool, remove the upraised splinters, and then use No. 1 garnet paper. The steel wool is used first to cut the splinters off the wood, for sandpaper has a tendency to imbed them back into the wood instead of cutting them off.

Before sanding operations are started, cut a broom handle off to between 8 and 10 inches, and

form 6 inches of one end to fit into the barrel channel of the fore-end. The end is then drilled for wood screws 4 inches apart and screwed into the fore-end, the short end extending out as a center. I shall assume that you have the checkering frame made. From now on this will be a valuable addition to your stock work, not only for checkering but for hand polishing as well. With the stock centered in the frame, all the wetting and sanding may be done without any danger of knocking the stock against any metal objects.

After each wetting, the steel wool is used first, then the sandpaper. After the first wetting, No. 1 garnet paper; second wetting is then followed by No. 0 sandpaper. Then No. 2/0 follows, and so on until you have reached the No. 7/0 paper, which is used for the final finish. The wetting and sanding is repeated until there is no further chance of the grain of the wood rising and the surface of the wood is perfectly smooth and free from any marks whatever. This operation is often termed "whiskering."

At this stage, the sling-swivel bows may be fitted into the butt stock and fore-end, and also the silver or gold ovals or shields may be inlaid, if inlays of any kind are desired. After these are glued into place, they are filed flush with the wood and the file-marks are removed with fine No. 7/0 sandpaper.

A very convenient sandpaper holder is a piece of cork measuring $1\frac{1}{2} \times 2 \times 3\frac{1}{2}$ inches. Cut your sandpaper so that it will just come up over the $1\frac{1}{2}$ -inch height. Smaller pieces of cork may be used to advantage, as well as the larger pieces to get into odd forms. You can also form pieces of the cork to take various radii. There is just enough "give" in cork to produce the proper sanding on a stock.

In sanding forearms, such as on single-shot rifles and fore-ends on shotguns, the best results are obtained by making holders to go between the centers on the checkering frame, holding the fore-ends fastened to these centers. With the work thus supported, you can turn the piece in the direction most convenient to work to. Doing such work as this in a vise is one of the most unhandy methods, for you do not have the support at the end, and for that reason you are unable to use any pressure on the sandpaper.

When sanding a stock—or for that matter any piece of wood—always sand in the direction of the grain of the wood. When sanding a fine piece of wood across the grain, even with the finest sandpaper, you will notice that it leaves marks; it is very much more difficult to remove these with the rottenstone when polishing.

The working of curly or bird's-eye maple requires a method of finishing very different from that used

on any of the walnut woods. When making a stock of curly maple or even bird's-eye, the exterior is roughed out with a sander made as Figure 83 illustrates. Fasten these to the spindle of the

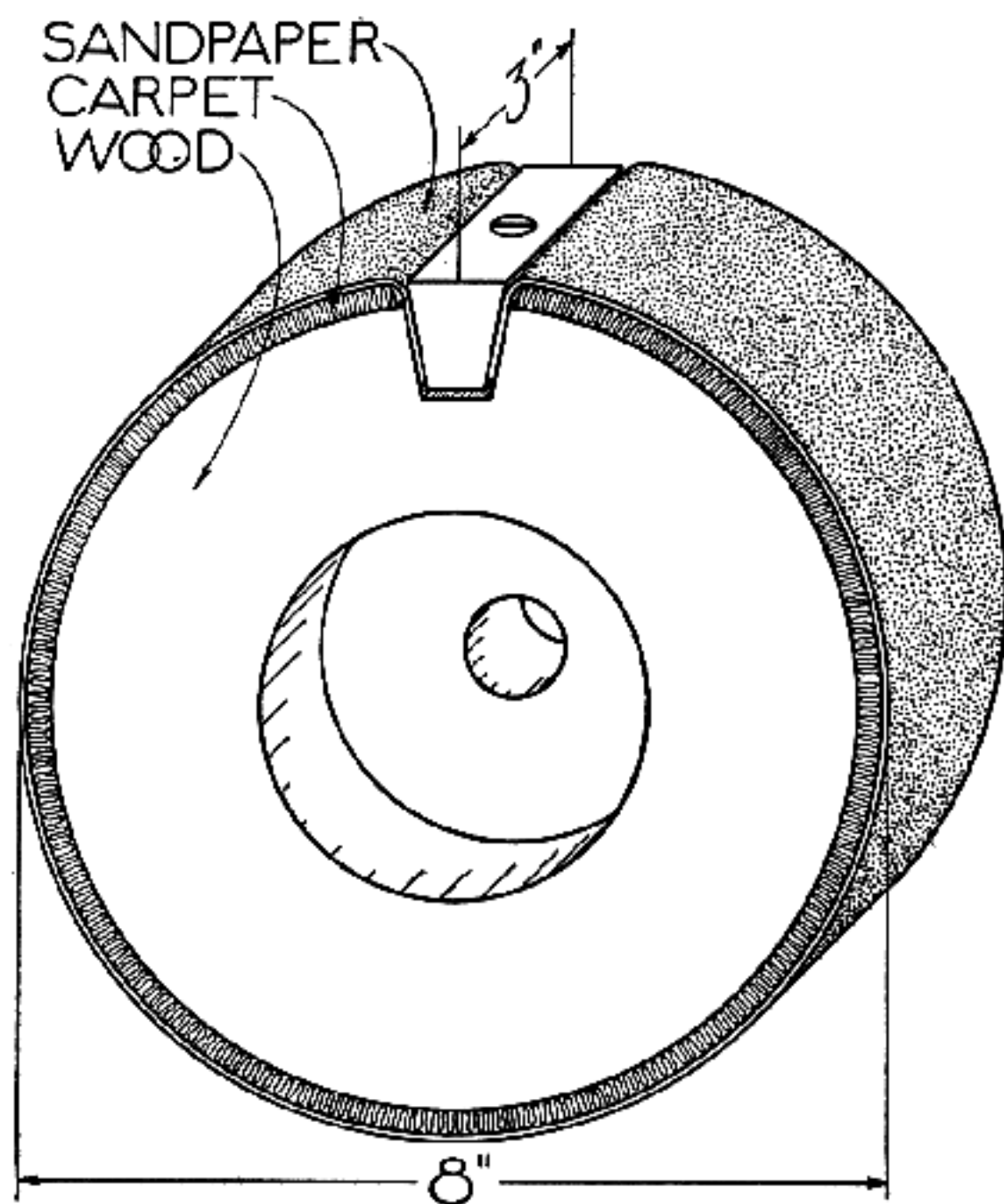

Fig. 83

Sanding drum for use on bench grinder

grinder. Turn the drums out of any good hardwood which does not have any checks, or glue $\frac{1}{2}$ -inch pieces together, crossing the grain on each piece as it is glued to the next, for strength. When this is completed, cut out a small section lengthwise with a wedge effect and make a wooden wedge to fit into this groove, allowing enough on the sides for the sandpaper. At the same time the wedge will be below the outside surface when it is pulled down tight. Wood screws may be used to hold the wedge in place.

When this is done, cover the face of the wood with carpet which has a good heavy nap, and tack the carpet to the face of the drum with the nap standing out. The edge of the carpet should come flush with the cut-out for the wedge. You may procure sandpaper for the drums from any of the large supply houses in any grade and width. Cut the length which will encircle the drum and allow enough for clamping the ends. Come down into the bottom of the cut-out, and place the wedge in position. Screw it in place, and as you pull the wedge down it will tighten the sandpaper. The small

opening left when the wedge is in place can never be noticed when the sanding is being done.

A sanding drum made in this manner will eliminate a lot of hand work, especially on the finishing of maple. Nearly all the roughing can be done with a heavy rasp, and the final roughing can be done on the sanding drum, except around the odd forms, such as the pistol grip and comb; but where a straight side can be worked, the sander will do a better job. Such a drum made for the grinder may be used for a number of wood operations, and when once used, you will be surprised to know what a large amount of work this will be called upon to do. The nap on the carpet gives the sandpaper the amount of elasticity required and at the same time has a very fast-cutting effect.

Many beginners often wonder how the round forearms are made, such as you find on the Winchester and Remington pump guns and automatics. At the factory they are bored out from a solid piece of wood on a special machine with a tool to remove the center without the least effort. However, you will have to bore this out on a lathe. This operation will also apply to fore-ends on tubular magazine rifles as well, except that the fore-end is formed instead of being turned after boring. First, square up the piece of wood that is to be used, and then remove the four corners with a plane, making the blank octagon. Shape when cutting the piece to length. Allow $\frac{1}{4}$ inch for finishing the ends. Chuck the blank in the lathe to run true, and use a $\frac{1}{2}$ to $\frac{3}{4}$ -inch drill to get a hole started. If you have a Forstner bit near the desired size of the finished hole, this will be much better than a drill. A regular auger bit cannot be used successfully, for it has a tendency to split the wood even tho you have left your blank large enough. After you first drill a hole, you can enlarge it by using a drill of larger size, so that the boring bar can pass through the hole first made.

After the center hole is enlarged, the following operation is to bore it out, using a boring bar with a square or round tool fastened in the end, the bar held in the tool post or a regular boring bar holder such as the Armstrong. As you have a long distance to bore out, do not remove too great an

amount of wood on each cut. The tool used must be ground with a long cutting lip and stoned to a keen cutting edge so that it will not tear the wood. Bore the hole to the desired size and face the end before removing from the chuck. On the Winchester pump guns, such as the Model 12, the ends are turned to a form so the nuts can hold the wood to the center without splitting.

Remove the fore-end from the chuck and chuck another piece of wood. Turn this so the fore-end can just be driven on with light taps. The end which is turned is driven on the arbor thus made, and the outside turned to any desired size or form. Very light cuts must be taken with a tool ground to a long cutting lip so that it will shave the wood instead of tearing. When it is completely turned, remove the fore-end from the chuck, and after removing from the mandrel, save it for the next job. After the locking nuts are in place, together with the pins or the tube, the barrel channel is cut out just so there is a free, even movement of the fore-end back and forth on the magazine. On the regular Winchester fore-ends, such as you have made, you will notice a considerable amount of end-play or more of a sloppy, twisting motion as the action is worked. This can be eliminated in the new fore-end by making a perfect fit in the channel to conform with the barrel. When all this is completed, turn another piece of wood which will just fit the tube so it can be used on the centers of the checkering frame for the sanding and checkering operations.

The styles of fore-end which have just been described are rather difficult for the beginner to make without a lathe. Some of the small fore-ends he may be able to make by boring out first and then shaping suitable wooden holders to perform the other operations, but for the larger ones he must have the proper equipment. Beaver-tail fore-ends or any special style of forearms, such as on single-barrel trap guns where the wood fits well up along the sides of the barrel, or on single-shot rifles which require special forearms, must be shaped on special wooden forms that can be clamped in the vise and worked upon without any danger of chipping the edges if clamped directly in the vise.

CHAPTER XI
Bedding Barrels
and Actions

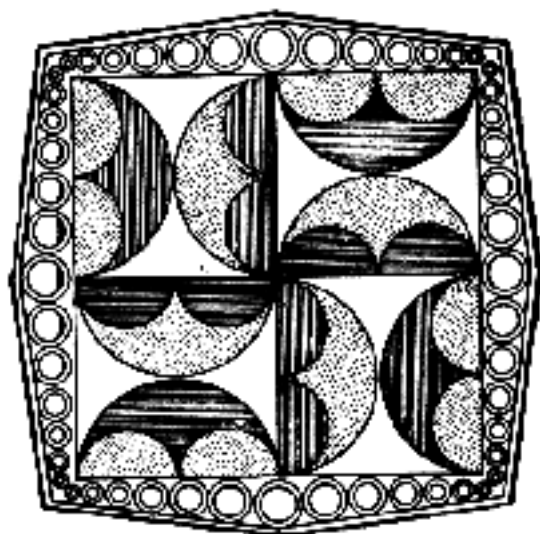

Bedding Barrels and Actions

THE undertaking of inletting a barrel and action into a blank by the beginner the first time usually results in one or two bad mistakes. One of these is to inlet the rear of the receiver into the blank too deep or not deep enough; the former is the most common, and when it happens the forearm stands away from the barrel often as much as a half-inch. Naturally the owner of such an arm is at a loss to know why his rifle will not shoot, especially when he has pulled the forearm up to the barrel with an encircling band. The amateur should have a clear impression in his mind of what he is about to do when he attempts the imbedding of an action and barrel into a blank of wood. I have touched upon this question in Chapter X, but on all important subjects we must be warned of certain dangers the second time, and this subject is one that every beginner should learn by heart.

Colonel Whelen's long term of duty at the U. S. Springfield Armory as an officer in charge of the experimental division enabled him to study a great many problems, and every one should benefit by his extensive tests and findings on the subject of bedding rifle barrels and actions. Figure 84 illustrates his standard design of rifle stock, showing the cheek piece. This can often be referred

to when laying out a stock; many express their desire for this design.

Since Chapter IX and this are related, it will be well for the reader to study the question from both angles and arrive at a clear understanding of the principles involved. The following was written by Colonel Whelen while he was studying the problem at the U. S. Springfield Armory:

"The bedding of the metal portions of the rifle, that is, the barrel, receiver, and guard, in its stock has a very important relationship to accuracy and to the maintenance of zero. To shoot really well, a rifle must be very stiff from butt to muzzle. No really good accuracy has, as a rule, been obtained from a *light* rifle having a two-piece stock—that is, a stock and forearm in distinct pieces and separated by a metal receiver, particularly when the butt stock is secured to the receiver by tangs and screws. Sometimes fairly good accuracy has been obtained where the stock of a light rifle is secured to the receiver by a long bolt passing through the stock to the butt and the screw set up very tightly (Sharp's and Ballard rifles, for example), because this is a very much stiffer method of attachment than the usual tangs and screws.

"If we search the records prior to about 1900, we find that really good accuracy had been ob-

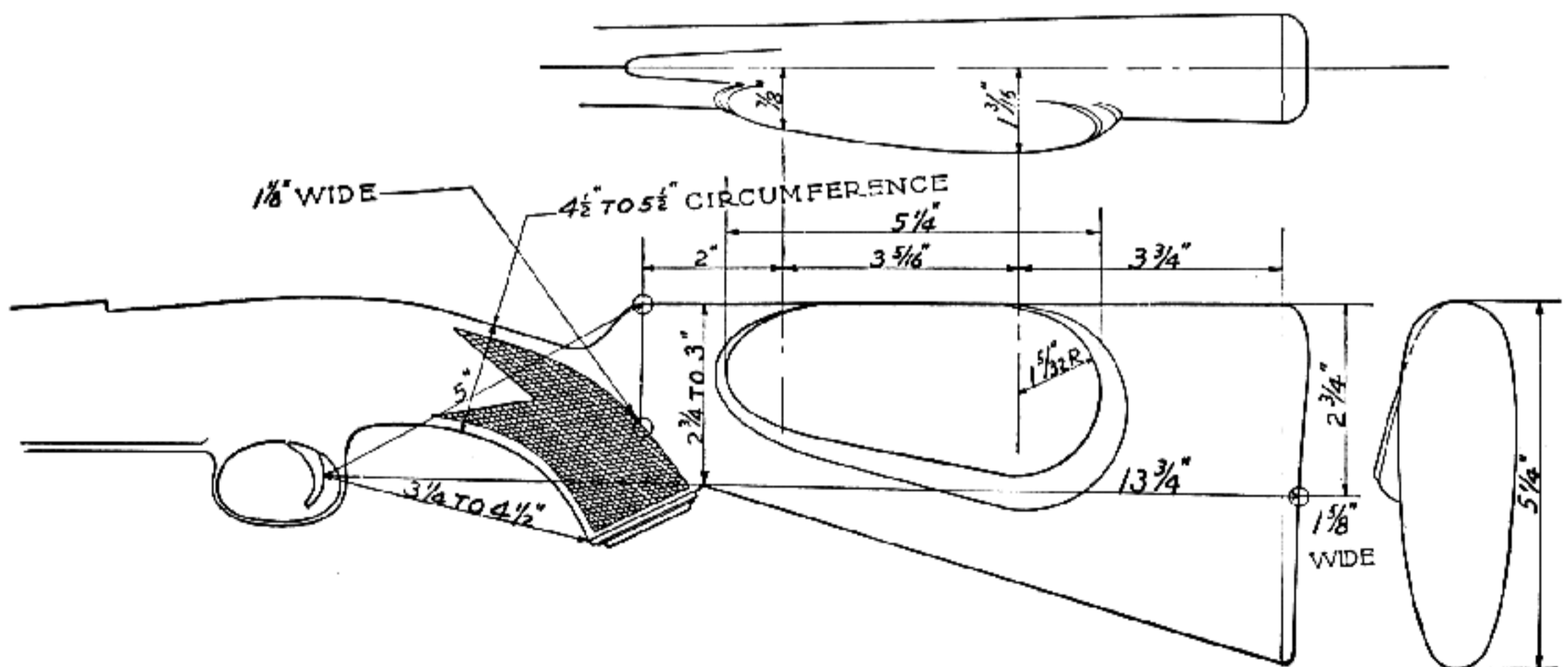

Fig. 84
Whelen design of cheek-piece and stock measurements

tained only from single-shot rifles having very heavy barrels. The heavier a barrel the more accurate it always is, other things being equal, and these stiff heavy barrels did much to make up for the poor design of the stock attachment. But it was very seldom indeed that really gilt edge accuracy was obtained even with these heavy-barreled rifles, and they can hardly be termed *light* rifles. By a light rifle, we mean one weighing 9 pounds or less.

"With light rifles, really gilt-edge accuracy has only been obtained with one-piece stocks, or more correctly speaking, with modern bolt-action rifles which have been properly bedded in their stocks in accordance with certain principles. Even the most perfectly made bolt-action barrel and breach action *will not shoot with good accuracy unless it be properly bedded in its stock*. By proper manufacture, gauging, and inspection, it is possible to make barrels and breech actions by quantity production so that they will practically always shoot with splendid accuracy when bedded right. But because of the nature of wood, it is not possible to construct a stock by quantity production to such accurate measurements that it will invariably bed right when assembled to the metal portions by ordinary screwing together. There is an art of bedding, and where the finest accuracy is desired, this must be done by hand by a workman who thoroughly understands the operation. Even so, fine accuracy is not assured unless it is proved by targeting the weapon.

"The fact that bedding had a decided effect on accuracy was first discovered in America by a small group of workmen at Springfield Armory about 1880. These workmen at that time were members of rifle teams shooting the old .45-70 Springfield rifle (which had a one-piece stock). It is believed that no official record was made at that time of the influence of bedding on accuracy. However, Mr. Freeman Bull talked of the matter to the then young employees of Springfield Armory before his retirement. About 1909, Springfield Armory began to manufacture rifles of selected and special accuracy for use at the national matches, and in an effort to secure better accuracy from those rifles, the employees, remembering what Mr. Bull had told them, began to experiment with bedding; in three or four years they evolved a method which practically always resulted in splendid accuracy. From Springfield Armory this knowledge gradually spread to other manufacturers. The Winchester Repeating Arms Company first began to apply it to their Model 52 rifles a few years after that famous model was placed on the market,

and as evidence of results one has only to examine the records made by that rifle in recent years. Lately, they have applied the same methods to the assembly of their Models 54 and 57 rifles. Certain of the custom rifle makers, notably Howe, Niedner, and Owen, learned this method around 1920 from their associations with officers and men in the Ordnance Department of the Army, and more recently all rifle manufacturers and gunsmiths actively interested in improving the accuracy of their rifles have become acquainted with it.

"In England, the effect of bedding on accuracy was discovered in attempts to make the Lee Enfield rifle shoot with greater accuracy. That rifle with its two-piece stock and its very light barrel is particularly sensitive to bedding, and when one searches literature on the subject of the accuracy of the Lee Enfield rifle, he finds whole volumes of instructions and suggestions about bedding. In Germany, bedding has been thoroughly learned by Mr. H. Gerlich, the maker of the Halger rifle, and as a result, that rifle has attained an enviable record for accuracy in Germany. Mention should also be made of the Swiss Martini free rifle used in international matches. This rifle has a two-piece stock, and its accuracy is due to an extremely heavy barrel plus a stock secured to the receiver by a heavy bolt passing completely through the stock and set up very tightly.

"At the present time at Springfield Armory, all the metal portions of the rifle are made to extremely close tolerances and are most rigidly gauged and inspected, so that fine accuracy is practically assured. After the rifles are assembled, they are sent to the range for targeting from machine rests before final acceptance. The .30-caliber rifles are capable of grouping their shots in about a 2½ to 3-inch circle at 200 meters (217 yards), and the .22-caliber rifles in the 10-ring of the small-bore target at 50 and 100 yards. If they do not group this well, they are returned to the manufacturing department for correction, and 49 out of 50 times it is found that the trouble is in the bedding. This having been corrected, the rifle invariably targets up to standard. It is a common occurrence to have a rifle target a 6 to 10-inch group at 200 meters, and upon being re-bedded in its stock, to target a 2 to 2½-inch group.

"The following is the method used by Springfield Armory in bedding the metal portions of Model 1903 rifles in their stocks to obtain the highest degree of accuracy, and maintenance of zero.

"The rear guard-screw bushing is regarded as essential. Great care is taken to insert it very

tightly in its hole in the stock, and to perfectly align it so that the rifle and receiver will not be canted to either side. The bushing and the guard screw must both be tight and firm in the stock.

"The wood surrounding the rear tang of the receiver and the rear tang of the guard must be a very tight fit on these parts, except that the wood in rear of the rear radius of the receiver tang should be relieved slightly to avoid tendency of the stock to split longitudinally in the small of the grip. The rear guard-screw should be screwed up very tightly, and should bind the receiver and guard absolutely at this part. If this screw becomes loose the rifle will at once begin to shoot very poorly.

"The rear surface of the recoil shoulder on the lower front portion of the receiver must bear solidly, tightly, and evenly against its rear vertical contact with the stock.

"The flat under-surface of the receiver in rear of the recoil shoulder should bear evenly and level on its seat on the stock. It is very essential that this seat be cut perfectly level in the walnut so that when the front guard screw is tightened it will hold barrel and receiver evenly with no tendency to cant to one side or the other. It helps out the rear guard-screw and bushing in this respect. If there is any strain which tends to cant the rifle to one side or the other the zero will vary continually.

"Moreover, when the stock is fitted to the barrel and receiver, before the guard-screws have been tightened, there should be a slight tolerance between the flat under-surface of the receiver in rear of the recoil shoulder and its flat seat on the stock. The two should not meet by say $\frac{1}{32}$ inch. Then when the guard-screws are tightened up, the front guard-screw should pull the stock up to meet the receiver,

and in doing so should in addition press the tip of the forearm or fore-end tight against the bottom of the barrel.

"In the case of the full-stocked forearm of the military-type rifle, the forearm touches the barrel only at its tip. The forearm should press upward against the bottom of the barrel at the upper band with a pressure of about five pounds. The upper band is assembled so that it does not touch the top half of the barrel. When the rifle has been completely assembled, the muzzle portion of the barrel should bear down on the tip of the stock, and there should be about $\frac{1}{32}$ inch clearance between the upper band and the top half of the barrel. In pressing up on the barrel of the rifle and down on the upper band, it should take about five pounds' pressure to cause the upper half of the barrel to touch the inside upper half of the upper band.

"In the case of rifles stocked with the Model 1923 pistol-grip stock with short forearm, the barrel should be accurately bedded for the entire length of the forearm, but the tip of the forearm should press upward against the bottom of the barrel a trifle harder than the remainder. That is, when the front screw is tightened the tip of the forearm should press up against the bottom of the barrel with about five pounds' pressure. Then the lower band should be fitted so as to bind the forearm quite tightly to the barrel. If a barrel band encircling the entire barrel is used, the band itself should not fit so tightly as to preclude the barrel elongating without buckling when warm from firing.

"The owner of the rifle should be informed that it is necessary to keep the two guard-screws screwed up very tight at all times. This caution applies to every type of rifle."

CHAPTER XII

Giving the Stock Its Final Finish

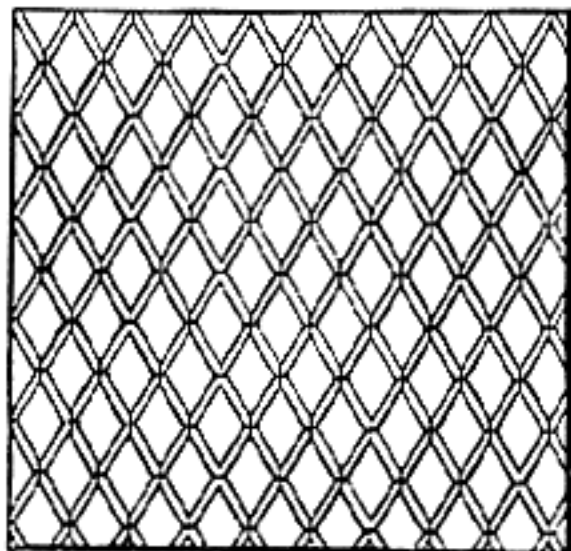

Giving the Stock Its Final Finish

THE proper finish applied to the wood of a gun stock causes the realization that the exterior appearance constitutes the beauty of the wood. Consequently we must be very particular in selecting a high and durable finish which will be most appropriate. The various materials named here are to utilize or produce these finishes and bring the character of the wood to the surface. The next consideration is durability. The use to which the gun is to be subjected determines this in many respects. If you should have a beautiful piece of wood in a stock and only wish the gun as a show piece, French polish will constitute the ideal finish. But if you wish a durable finish which can stand the hardest usage, we must turn to what is commonly called the "dull London oil finish." When linseed oil alone is used on American walnut, it tends to darken the wood to such an extent that it kills the beautiful figure, so we must vary our methods and use other materials to bring out the character in the wood. An oil finish is more successful on English and Circassian walnuts. Italian and French walnuts also take it very nicely, altho it must be used discreetly or it will kill their beauty. Nature has woven into the fiber of each of these woods a richness and variety of coloring which is always pleasing in appearance, and in the exquisite grain and figure of these woods she has traced patterns far beyond the reach of any artist. The best finish is that which accentuates these natural beauties and enhances them with color. There are few woods lacking beauty of structure when the experienced gunmaker knows how to bring out this beauty.

The beginner's ideal must necessarily be simple so that he can make the most of what he has to work with and at the same time produce a maximum of beauty and serviceability. A wise plan will be to experiment with different kinds of woods to obtain some experience before applying the final finish. Let us take for example our American walnut. Procure four different pieces: one from Ohio, one from Pennsylvania, one from Kentucky, and one from Texas. From each of these samples finish a board as you would a stock, and have them measure $\frac{1}{2}$ x 3 x 10 inches. Give each piece a coat of raw linseed oil on one side, being very careful not to get any oil on the opposite side.

Stand these up on end, and let dry for two days, then polish with rottenstone, a process described later in this chapter. Stand the four in the light and see the different results one coat of oil produced on each board. On the opposite side give them a coat of filler, also described later. Then give each one a coat of French polish, which will bring out the true character of the wood. On the oiled surface, apply a coat of French polish. At that point judge the differences.

Notice how soil conditions influence the character of these woods. On the better woods, such as French, Italian and Circassian walnut, we must carry the first oiling of the wood to a certain degree and stop when the critical point is reached, especially on darker woods. On lighter grades of walnut, either foreign or domestic, the process which has always been recommended may be applied; this process is mixing one part turpentine and three parts raw linseed oil, and applying coats of this mixture until the wood will not absorb any more. This is the correct method for light porous walnut, but such a treatment would ruin a highly figured wood such as French or Circassian. These woods have a very close grain; it is impossible to penetrate with the oil and turpentine over $\frac{3}{64}$ inch under the surface of the wood, and by applying further coats of the mixture you only darken the surface and destroy all figure.

Undoubtedly this chapter will be read by the man who has had more or less experience in wood finishing, and also the man who takes great pride with his wife in choosing their furniture and home decorations. However, you will find stock finishing a very different problem and one to be treated from an entirely different angle. Then there is the amateur who does not know the first principles of finishing. He may have to select a piece of wood from his local source of supply, wood of such a nature as to necessitate a stain of mahogany or walnut to darken it so that it will resemble the more expensive walnut. Amateurs seldom choose the more expensive woods to begin with. They are likely to select one of our domestic woods, such as maple, cherry, beech, ash, birch, black walnut, or apple. When they do, it is possible to apply a stain and finally the finish to protect both the color

and wood from moisture. When chemical stains are used on hardwoods like maple, birch or apple, it is important to apply them uniformly over the surface to avoid blotched areas of color. A coat of water washed on first with a sponge just before the stain is applied will help to spread the stain evenly, if it is done before the water is dry.

The chemicals used for staining purposes are many, and they are used in various combinations. The acid and alkaline stains most commonly used are these:

Tannic acid	Lime
Picric acid	Potassium permanganate
Acetic acid	Nitric acid
Sulfuric acid	Chlorid of iron
Hydrochloric acid	Manganese sulfate
Ammonia	

Oil Finishes — All woods are composed of fibers and cells, and while growing, these cells are filled with water or sap. When the wood is seasoned, the surface cells are little holes or pores. In black walnut they are fairly large and must be filled, but on close-grained French, Italian, or Circassian, a filler is not necessary, tho desirable. At one time I never used a wood filler on any of these woods, but I have found that it will produce a more satisfactory finish on almost any type of wood.

The importance of filling the pores in wood is indicated by the fact that an expert stock-maker inspects a filled surface after it is dry with a magnifying glass. If he finds a number of pin holes in the filled surface indicating filled bridges over the smallest pores, he applies the second coat of a thinner consistency, allowing it to dry until it is hard, and then using fine steel wool to bring it down to the bare wood.

The basic materials used for mixing fillers must be ground very fine. The chief material used in a high-class filler is silica (silex). It is doubtful whether any other material is as good as a very fine water-floated silica. It is white when dry, but being quite transparent, takes on the color of whatever substance it is mixed with. Silica is inert chemically, showing no unfavorable reactions when mixed with other pigments and liquids, such as walnut filler, which is put on the market by the Sherwin Williams Company; this is what the beginner will use.

The stock to be finished in oil should be deserving of the most thorough work in preparing it for the finishing process. It should first be dusted off with a brush. Greasy hands should not touch the surface of the wood, for they will cause spots which will show through the final finish. Perspiration also produces an effect which can not be removed unless the stock is again finished. Maple will turn a pink

color if perspiration touches it, so it is better not to attempt to handle this wood when the weather is extremely hot.

When the stock is thus prepared, apply a coat of filler, rubbing it in across the grain so it will fill the pores of the wood evenly. The most successful way to do this is to fasten the stock between the centers in the checkering frame. Let it stand for one hour or more and remove it with a heavy piece of cloth or clean burlap sack, rubbing the filler off against the grain. After removing the heaviest part of the filler, let it stand again for five or six hours and then go over the surface very lightly with No. 3/0 steel wool. Follow with No. 7/0 sandpaper, and apply a coat of raw linseed oil. The method thus described is for American walnut. For the fine-grained and figured woods such as French, Italian, and Circassian walnut, the oil is applied first and the stock allowed to stand for three days. On very darkly figured wood one coat of raw linseed oil may be the only application required. This is where you must be the judge, for the second may darken the wood too much and kill the figure. Then again the wood may be of such a nature that you can apply from four to six coats of the raw oil and still retain the character. When more than one application of oil is given, always allow the stock to stand three days before more oil is applied, as this length of time tends to oxidize the oil in the wood; preceding applications are only absorbed by the more porous sections of the wood, and the hard portions will build up the oil. When the desired color and figures are brought out by this oil treatment, let the stock stand one week to thoroughly oxidize the raw linseed oil. Then, with No. 3/0 steel wool completely remove any oil which has been built up on the surface and apply a coat of wood filler (following instructions given for wood fillers). Again go over the surface with steel wool, burlap sack, or heavy cloth. The stock is now prepared to be rubbed with the rottenstone process, which is treated later.

On American walnut the filler is used first; this shortens the period of oiling which must be done to bring out character in the wood; otherwise it will darken to such an extent that it will become black and void of all figure. Naturally you want to avoid this last, regardless of what other advice you may have received. The professional gunmaker strives for beauty in walnut regardless of the species, and at the same time tries to insure the wood against absorbing moisture. A few years ago nearly all the American walnut used was the common Mississippi-bottom walnut; even today this is still used by the Springfield Armory and other gun manufacturers. On this class of walnut it makes no difference how

many coats of oil are applied, for, since it is a very porous wood, it will absorb between twenty and thirty applications without harm to the figure or character. Nearly all the advice given in the past was based on this class of wood. Today we must change our ideas and work with different methods in order to bring out beauty which nature has so generously bestowed upon us, instead of hiding it.

When you experimented with the four different samples of American walnut, you were given the key to work by on the stock you are going to finish. Again you must be the judge of the number of coats of oil the wood will stand before it begins to lose its character. On black walnut there are no objections to preceding applications of oil. After the first coat, eight hours should elapse before another wetting of the raw linseed oil, for in that time the wood will absorb all the oil. After the second coat a schedule of time should be laid out, increasing the time by four hours, until you are letting the stock stand three days in order for the raw oil to become oxidized into the wood. When the oil has brought the figure and color out, let it stand one week and then use steel wool to remove the oil that has built up. The stock will then be ready for the rottenstone treatment.

Rottenstone Treatment—The tools used for rubbing with rottenstone are simply a piece of felt pad which should be fairly soft for fine rubbing and hard for coarse rubbing. You may purchase this felt in sheets from $\frac{1}{4}$ to 1 inch thick. It is sold by the pound and can be cut to suit the job. Old felt hats can be cut up, tho this felt is too thin for good work. The felt is cut about 3 x 5 inches and tacked at two ends on a block measuring 3 x 4 inches. Smaller blocks are also made, measuring 1 x 5 inches, to rub around the bead on the cheek piece. The felt is turned up at the two ends and tacked so the heads of the tacks will not come in contact with the surface of the stock when being rubbed.

There are various kinds of rubbing pads on the market, but the ones you make, as shown in Figure 85, will be best for this purpose. The narrow felt pad may be glued instead of tacked to the surface of the wood. Naturally other things may be used for rubbing, such as burlap, curled hair, haircloth, etc., but you will find that none are as good as felt for this work.

The proper procedure to follow in rubbing with rottenstone and water follows: Make sure that the raw linseed oil has oxidized well before any rubbing is done. Then place the rottenstone in a cigar box or any kind of dish that will be convenient. Soak the felt pad in water. Before any

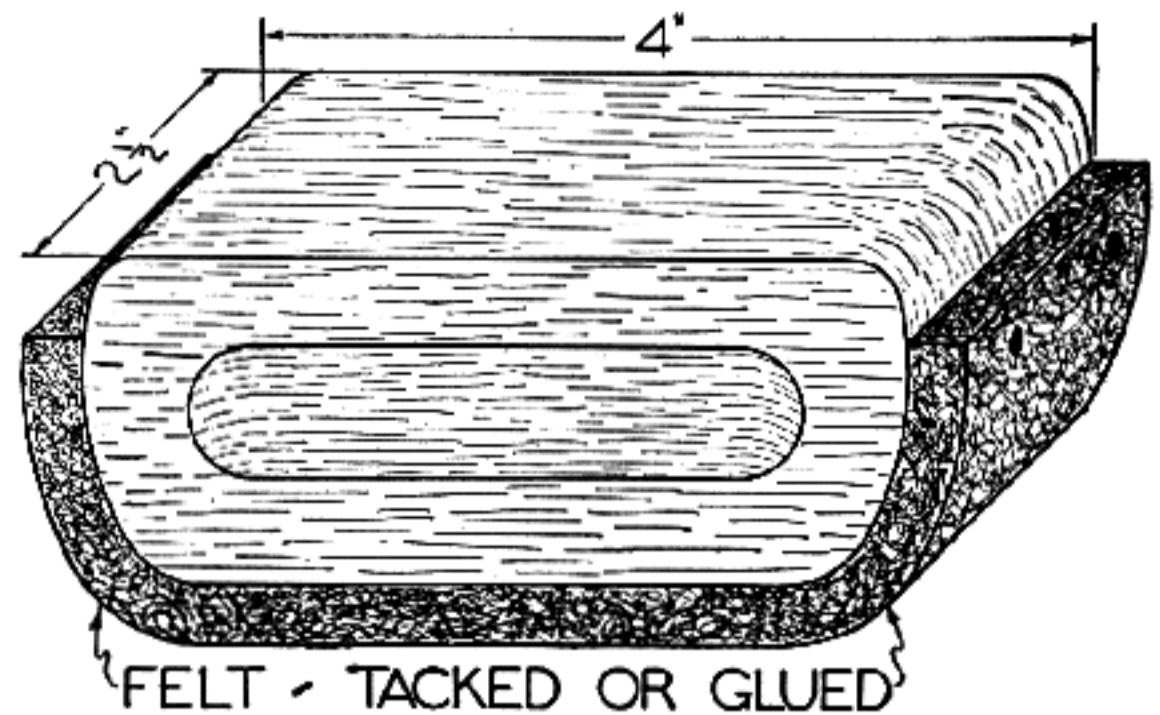

Fig. 85
Rubbing pad for polishing a finished stock

rubbing is done, place the stock between centers on the checkering frame, which will enable you to rub the entire surface of the stock at will by just running it on the centers. Dip the wet felt pad into the rottenstone to put a thin coating of dry powder on the pad, and begin rubbing the surface with a light pressure, gradually increasing it to the degree of pressure you can maintain comfortably for a long time over the whole surface where straight rubbing can be done. Change pads for the beads on the cheek piece and also the pistol grip. Rub with, and never across, the wood grain; that is, rub in the direction in which the wood fibers extend. If you rub across the grain, you will scratch the surface of the stock so that it will be difficult to remove the marks. Rub in fairly long straight strokes—never in a circular direction.

Success in rubbing depends upon doing the work thoroughly. Cover every part of the stock with the same pressure; first with coarse felt, then fine felt for the final finish. There is no need to count strokes, but a little practise will teach you to stop rubbing when the required smooth surface is reached.

Rubbing a stock is very much like sanding, for it is strenuous labor at best. However, many beginners will work much harder at first than is actually necessary. Use your head instead of your muscles, and a better job will result with less work. The rubbing is a very important part of the work on a gun stock, as it adds to the luster or depth of the finish.

Keep a sharp lookout for caking or gumming of the felt pad. To avoid this, wash the pad in clean water occasionally. The raw linseed oil which is not dry will cake on the felt easily. Of course you will get some caking from the oil, but not enough to hurt very much. There is also an oil and rottenstone rubbing which is done on the final completion of the oil finish and will be explained later in the chapter.

Muslin-wheel Treatment of Rubbing—A much faster method to produce a very satisfactory rottenstone rubbing is done on an 8-inch circular muslin wheel. These are sewn from the center to the outer edge, so before the application of paste to the wheel, the outer circle of stitches should be removed; this lets the muslin spread apart when the pressure of the stock is placed against it. Three or four of these wheels are used together on one side of the electric grinder. A heavy paste is made from rottenstone and finishing oil, or rottenstone and water. Fill a glass jar with a screw top (a pint Mason fruit jar is preferable) half full of rottenstone, and mix in the oil until it has the consistency of a very heavy paste. Coat the outer diameter of the wheel with this, working it well into the free sections of the muslin, and let stand for 24 hours. It is not necessary to let it rest on the grinder spindle, but on a hook, so that the wheels will be in a vertical position. After 24 hours, tighten on the grinder spindle and with a clean piece of planed flat walnut, start the motor and hold the flat side of the wood against the wheel to spread the paste evenly. Before the paste is applied to the outer surface, see that the wheels run perfectly true, for a wheel that runs out very badly will produce an uneven surface on the stock.

The rubbing treatments require time and labor to produce a high finish on the surface of the stock, but you will be able to produce the same results in a very short period of time, not only on the wood surface but also on the buffalo-horn tip and pistol-grip cap—also on the butt plate if you are using buffalo horn. The rottenstone and water are used in a similar manner.

An excellent paste for polishing buffalo horn is prepared by adding fine rouge powder to finishing-stock oil. Mix these together until a very thick heavy paste is formed. This is applied to new muslin wheels in the same manner as the rottenstone paste and allowed to stand 24 hours. Smooth this off with a clean hardwood surface board; when used in conjunction with the prepared rottenstone wheel to complete the final high polish on the horn, the paste must be hardened before use on such parts as the tip, grip cap, and butt plate, or any other parts where buffalo horn is used.

Having thus prepared these two wheels and the stock, you may begin the rubbing operation on the stock. When you rubbed by hand, the pressure you applied with the felt pads varied according to the method used. Now you have an entirely different condition to contend with. With a fast-revolving wheel, the speed at which the outer surface of the wheel passes over the wood is very high. Hold the stock at an angle of about 45 degrees; gently

press the stock against the wheel, working it in a vertical direction with rather long sweeps on the straight surfaces with the stock held on the under side of the wheel center. Continue to pass the stock back and forth over the entire surface, always working lengthwise with the grain of the wood. Around and back of the pistol grip and cheek piece, you must follow the contours by applying very little pressure. The horn parts may be polished in any direction most convenient.

As you continue over the stock surface you will notice a high luster coming out on the wood, but great care must be taken that your pressure is even, for too much pressure tends to cause a burning effect in spots over the wood or buffalo horn. When the stock is polished to a finish which is perfect in your opinion, place the rouge wheel on the spindle and finish the buffalo-horn parts to the highest polish. With all this completed, the checkering operation is next in line.

Linseed Oil—The commercial raw linseed oil produced in this country is obtained from flaxseed by steam cooking and hydraulic processes, whereas some of the linseed oil from the British Isles is obtained by pressing it from the seed. It is passed through rollers and crushed. This is not a very economical method, but produces the finest linseed oil for gun stocks.

The latter is by far the best when it can be procured. The Calcutta raw linseed oil obtained from England is the best, providing it does not become rancid. The beginner should acquaint himself with the characteristics of this oil and its actions under common circumstances.

There is no more serviceable finish today than that produced by coat after coat of hot linseed oil. When the oil is applied hot, it penetrates more deeply and makes a more serviceable finish, especially if you are not particular about figure in the wood and intend to subject the arm to hard service, let us say in the tropics, where the wood will be likely to absorb moisture. The method used to prepare such oil for penetration is:

FORMULA No. 1

1 pint raw linseed oil
 ½ pint turpentine

Heat the oil and turpentine together until they reach the boiling point, and apply to the stock with a swab as soon as removed from the fire. Oil applied in this form penetrates deeply into the wood. Let it dry for an hour or so, and wipe off any excess remaining on the surface. Let the stock stand for 24 hours and repeat the process until the wood will not absorb any more, and then after each

coat rub the surface of the wood with the palm of your hand. When the surplus oil is removed after one hour, rub until all the oil disappears into the wood. Let the stock stand for three days before another application. When preparing an oil finish such as this, the finishing coats, while applied hot, must only be put on very lightly, as the previous coats have become oxidized in the wood, and what you are now putting on is building up a surface finish. The repeated heating of the same oil causes it to become very dark and heavy, and toward the last finishing application it is very thick, producing the results we want. Even tho the wood is darkened, this makes one of the most satisfactory stock finishes, for water will not spot the wood, nor will heat affect it in any way.

Boiled Linseed Oil—The pure boiled linseed oil is very difficult to obtain and the commercial boiled oil which stock makers use is the raw linseed oil with a dryer added. For the stock maker's purpose he must prepare his own finishing oil to obtain the "dull London finish." This finish brings out the fine figure in wood, and will last for years, but it is not so durable a finish as the hot linseed oil application previously described. Of course, when we use a dull London oil finish we are after different results from that of bringing out the character in a finer piece of wood. Naturally, like any other oil finish, it can always be restored by a little rubbing with the same prepared oil.

A number of formulas have been used to obtain this finish; the most reliable ones are these which I have worked out. They suit various conditions in the grades of wood, and are used to obtain the "dull London oil finish." The term "dull London oil finish" has been more or less a means for writers to describe an indefinite kind of oil finish, but 90 per cent of the gunmakers of the world have been using other means of producing such a finish on their stocks than boiled linseed oil alone or even the addition of turpentine.

The nearest real oil finish that can be given any gun stock is the one in which the oil is boiled and applied to the wood while hot. The rubbing you give it with the palm of your hand is a very important factor. The best results are obtained by continuous boiling of the same oil; by the time the stock is completed, the oil will be darkened so greatly and will be so heavy and thick that each coat will build up a harder and more durable surface and at the same time destroy all beauty or character in the wood. You will find that only a few men require such a finish, so you will have to produce another that is equal and take a shorter period of time. This is:

FORMULA No. 2

32 oz. boiled linseed oil
4 " pure turpentine
½ " alkanet root

Boil the alkanet root in the turpentine. Use only enough heat to allow the turpentine to extract color from the root. Let cool and add to the linseed oil. Heat these together and allow them to come to the simmering point. See that no smoke arises from the oil. Let cool. This formula is used on light walnut when it is desired to impart a reddish tint to the wood. Use the raw linseed oil first to build up an oxidizing surface. Discontinue when the desired shade of color is reached; then apply this formula, using very little of the oil in the palm of your hand, and rub well into the surface of the wood until dry. After applying as many coats as you think advisable, let stand until thoroughly dry. There may be a good many of these oil coats, and if so, the time required will be from six to eight weeks, or even more. Be very careful not to use too much oil in the palm of your hand, for this will produce a gummy, uneven surface. If this condition should exist when completed, use No. 3/0 steel wool to remove the surface, and start all over again. When the desired finish is obtained, and the oil has been built up to a raised and hard condition from the surface of the stock and looks well, attach a clean piece of felt to the rubbing block and sift rottenstone through a cloth bag. Soak the felt in sweet oil and then in the sifted rottenstone. Rub the surface, using very light pressure on the rubbing tool, always in the direction of the grain. Continue until a very dull finish appears on the surface. Wipe the stock, removing all traces of sweet oil and rottenstone, and let stand for three days; this may be followed with a treatment of Formula No. 5 or 6.

FORMULA No. 3

32 oz. boiled linseed oil
1 oz. spar varnish
3 oz. turpentine
200 grains beeswax
3 tsp. Venice turpentine
2 oz. burnt umber

Heat all together, allowing the mixture to come to a simmer, or until small beads appear on the surface. Let simmer for ten minutes; allow to cool and pour in a bottle to be used as needed.

This formula is used for medium dark woods where figure must be retained after the raw linseed oil treatments and rubbed down with rottenstone, thus preparing the stock for this formula. This oil is rubbed into the wood in the same manner as in Formula No. 2, and continued until the desired finish is obtained. You will find a different

condition existing when you first begin to use the oil. The surface of the wood will have a broken finish where some of the oil has penetrated and partially remained on the surface, but this will disappear as each application is given. Two days or more should elapse before another rubbing is given, and after it has been rubbed it must be placed in a warm room free from dust. You will notice how atmospheric conditions cause the oil to remain "tacky" on damp days. During such weather, let the stock remain for a longer period before another rubbing takes place. This formula brings out a beautiful finish, and gives the effect of looking at the figure of the wood through a glass. It is also very durable. Apply the rottenstone and sweet oil as in Formula No. 2.

FORMULA No. 4	
32 oz.	boiled linseed oil
3 "	shellac
3 "	turpentine
1 "	burnt umber
200 grains	beeswax
½ "	alkanet root
1 tsp.	Venice turpentine

Heat turpentine and alkanet root together to extract the color. Do not allow to boil, except to a point where the desired extraction is obtained. Strain through filtering paper and add other ingredients. Boil very slowly for twenty minutes as described in previous formulas.

The oil thus mixed is for very dark Circassian, French, or Italian walnuts. The proper number of raw linseed applications were given to bring out the dark character of the wood. Only one or two coats of this oil were probably used to attain such results because the figure might have been ruined. An experienced stock maker can tell when the correct number of coats have been applied. In time you will know before you ever begin to oil the wood just what the wood will require, but the beginner must solve such problems himself, and the best and only way this can be done is to save scrap pieces of wood from the blank you are working on. Finish one side as you have your stock; then make one application of raw oil to see just what the results will be, letting it stand one or two days. The first application will give you an idea of just how dark the wood is, but the second, third, and fourth may kill all figure if it is a finer blank.

These are the basic formulas used on walnuts of the highest grades. On the lighter low-grade blanks of European walnut, hot raw linseed oil and turpentine may be used. On the black or American walnut of the better grade, the three last formulas may be used to obtain the "dull London oil finish." You will find that all mixtures are of a flexible nature, and may be applied in a variety of ways

to a number of woods. The finishes which you will obtain from using these formulas are of a lasting durable type, and when great care is taken you will find that the luster improves with age, and that water does not injure it greatly.

You will probably wonder why varnish and shellac have been added to the boiled linseed oil and other ingredients. Very often formulas call for shellac, one of the substances used in a finishing oil, tho it does not produce as durable a finish as the spar varnish. Shellac may be used as a filler after the raw linseed in a number of instances on very fine wood. One coat is applied and the surface rubbed down with No. 3/0 steel wool; then sanded with No. 5/0 and No. 7/0 sandpaper, and then with rottenstone. The shellac has completely filled the pores of the wood, and when the finishing oil is applied, it begins to build up on the surface and does not darken the wood any further. Venice turpentine is added to the formulas to prevent cracking of the varnish or shellac; this is advisable when varnish or shellac is used. Alkanet root is used to impart a red tint to the oil, very desirable when a piece of wood is void of an attractive color. Burnt umber is added to give a dull appearance to the finish, and at the same time to fill the small pores of the wood. If you should wish an exceptionally lustrous finish, it is possible to use China-wood oil or tung oil, which is obtained from the China-berry tree. This oil is a little more expensive than the boiled linseed oil and not as desirable to use. It is put out by paint manufacturers for painting steel office furniture. The China-wood oil, to which zinc is added, has a poisonous effect on some men's skin, especially when the cheek comes in contact with it; therefore avoid its use. A very good polish for a gun stock after you have oiled it is made as follows:

FORMULA No. 5	
4 oz.	boiled linseed oil
8 "	turpentine
8 "	beeswax
1 "	Venice turpentine

Melt together over a slow fire. A finish in which wax is used is not intended for durability, but for beauty; nor is it to be recommended for an undercoating for the last three formulas, as it will not wear well.

Another good stock polish is made as follows:

FORMULA No. 6	
1 pint	boiled linseed oil
200 grains	gum arabic (dissolved in alcohol)
1 oz.	alkanet root
200 grains	rose pink
150 c.c.	vinegar

Heat together for one-half hour, but do not al-

low the mixture to come to the boiling point; just let it simmer gently. To apply this polish, rub a small quantity on the stock, and let remain for ten hours; then rub it clean with linen cloth. With a few such applications you will bring out a very superior finish. This is also an excellent polish for furniture. There are so many different furniture polishes on the market that the beginner must use good judgment if he should decide to use one of them on a gun stock. If you must use a furniture polish for a shellacked or varnished stock you can make a very good polish as follows:

FORMULA No. 7

20 oz.	raw linseed oil
2 "	alcohol
8 "	dilute acetic acid
1 "	solution of ammonium chlorid
½ "	spirits camphor
1 "	antimony chlorid

Add the antimony chlorid to the oil, then the camphor and acid, and finally the ammonium chlorid. Shake after each addition.

French Polish—French polishing consists of the repeated rubbing of shellac into the stock, using a "rubber" or pad that is slightly coated with raw linseed oil, which makes the rubbing easier. First, prepare the wood with raw linseed oil until you have the correct color or character of the wood showing. If you are using a light piece of wood, it is far better to stain it first, which operation will be explained later. After oiling, the wood filler is used, followed by the shellac polish. As shellac is affected by cold and dampness, the work requires a temperature of not much less than 70 degrees. Shellac is rubbed into the wood until it is filled and the surface made smooth with a soft polish. It is a very beautiful and durable form of stock finish. Orange or white shellac is used, and to this any desired coloring may be added.

The "rubber" used is made of clean woolen cloth, rolled up into a bunch. Over this is drawn a piece of clean soft muslin, the edges drawn up and over the sides of the rubber and tied, thus forming a handle to hold while using. For irregular surfaces, such as those around the comb, pistol grip, and cheek piece, make a smaller rubber in the manner described. They must be perfectly smooth on the rubbing surfaces, and free from wrinkles or creases.

When ready to polish, apply a small amount of shellac to the face of the rubber, being very careful not to get on too much. The idea is to have on just enough shellac to cover the given surface. If too much is used, it causes a ridged effect, spoiling the work; hence, it will be seen that the process

requires great care and skill. Having applied the shellac to the face of the rubber, apply to it also a few drops of raw linseed oil, the oil making the rubbing easier and smoother.

Begin rubbing at a certain part of the work and rub evenly with very light pressure, working in a circular manner until you gradually reach the opposite part of the stock. Occasionally, apply a drop or two of oil to the rubber. After you once start rubbing, keep the rubber in motion until you have reached the end of the work; and even then you must not stop abruptly, but gently slide the rubber off the work, and so leave no ridge or other mark that will have to be removed. This is very important. Do not allow your rubber to become dry as you rub, but apply a little more shellac and oil. After you have rubbed in several coats, a soft luster will begin to appear. Each time you apply shellac to the pad, rub it in a circular direction in the palm of your hand, thus equalizing the shellac on the pad. If the muslin covering becomes shiny, put on a new covering.

In case you should be unfortunate enough to have rubber marks appear on the surface of the stock, remove them by rubbing with the wet rubber, but beginning at a point where you left off and working in the reverse direction.

Place the linseed oil in a saucer if you wish, and the shellac in another; however, a bottle is better. In removing rubber marks, use a half-dry rubber and bear with somewhat greater pressure than when rubbing at first. Rubbing too much in one place will result in softening the whole body of the polish, causing it either to rub up or rub into ridges. If the room is too cold or too damp, it will produce a milky surface. To remedy this, place the stock near a fire, and let the heat act upon it until the milky effect disappears.

Apply only one coat of polish a day, but rub in enough coats to form a good film of shellac on the surface of the stock. Continue this until you have a well-built surface, which may require a week or longer to complete.

If the work shows a uniformly even surface, it may be "spirited off." This is done with alcohol and the rubber you used to polish with. The operation requires great care, as the alcohol injures the polish easily. Pass the rubber, dampened with alcohol, lightly and quickly over the surface, being careful to use it very sparingly and with constant care. This operation removes the oil left on the polish, which if not removed would mar the surface by dimming it. After doing this—if the work has been done properly—the polish will appear bright and beautiful.

Sometimes it is better to use a new pad of clean

muslin over a pad of raw cotton or cheese cloth. Again I repeat, rub with a circular movement. French polish is very desirable on shotguns or factory-made arms of the better type, and answers very well; 90 per cent of the gun owners are far better satisfied with it even tho the oil finish is superior.

Violin-varnish Finish—Fossil gum amber is the right kind of varnish to produce the violin finish so many admire. Of course it is not altogether recommended for gun stocks; yet many prefer it, so it is well for the gunsmith to have such information as this on hand. The varnish is finely colored in various tones or tints, as follows: golden yellow, golden amber, golden orange, light golden, red, dark ruby red, deep blood red, reddish amber, golden brown, and very dark reddish brown.

Not the wood but the varnish is stained. First, the stock is prepared with the usual sanding and rottenstone treatments, and a coat of white or very pale varnish is rubbed into the pores of the wood. This is left for a week, then a second coat of varnish is applied. When the second coat has dried sufficiently, it is rubbed down either with rottenstone or with pumice and sweet oil, to secure a polish. Wipe off very thoroughly. From two to five coats of the colored varnish—just enough to produce the required depth of color—should be applied. To do a good job will take about three weeks, and a finer job will take longer. The varnish dries very slowly, but produces a tough and durable finish. The glossary of chemicals and substances, Volume II, contains a number of coloring materials to use in the varnish to produce whichever effect you may have chosen.

Stains and Their Uses—There are two kinds of stains used in the staining of wood for a gun stock, and it is well to learn their characteristics and the best use you can make of them. They are: water-soluble anilin and other coal-tar dye colors; chemical stains (acid and alkaline). The uses of the former are not well known, even tho the substances are the more modern for staining wood. The chemical-acid stain is more commonly used to change the color of woods such as maple, beech, birch, cherry, ash, and light walnut. The chemical stain penetrates deeper than any other kind. When used hot it penetrates deeper than when cold, and when the wood, being stained naturally, contains some of the same chemicals as constitute the stain, it penetrates the wood even deeper. It is well to keep in mind that man does not create acids and alkalies. The chemist doesn't create anything; he simply separates and concentrates acids and

alkalies from other substances. For instance, one of the stain chemicals much used is tannic acid. It is a chemical concentrated and separated by chemists from oak bark and gall nuts, from a vegetable substance called tannin. Most lumber contains tannic acid, some a larger amount than others. It is all quite simple and very interesting, yet most of us, not being chemists, feel that we cannot understand these things. We might profitably understand much more of chemistry, which is so interwoven with life that we meet it at every turn, if we would but pursue the subject a little more.

The use of chemical stains by the student is a little uncertain at first because it is not easy to determine how strong to make the solutions to produce the color wanted. You must test samples of the wood to be used in the particular stock, and mix these accordingly. After a little experimenting, you are able to measure chemical solutions to better advantage before you put them on the surface of the stock.

The colors produced by chemical stains are the most permanent known, usually because they bring about natural chemical changes in the wood and penetrate deeply. Chemical stains should be mixed and stored in glass or earthenware jugs and kept corked tightly when not in use. Some mixtures destroy tin or other metal containers very quickly.

When chemical stains are used on hardwoods like maple, it is important to apply them uniformly over the surface in order to avoid blotched areas of color. The chemicals used for staining purposes are many and they are used in various combinations, of which there is a list given in the first part of the chapter. I shall mention here only some of the colors chemicals will produce on light woods.

Nitric Acid—This acid diluted with from four to six parts of water produces yellow stains. When less water is used, the color resulting from it is a reddish yellow, depending on the kind of wood. When used raw, the color is a reddish brown.

Tannic Acid—When this acid is diluted with water and brushed on a stock, it is the basis of a brown stain. The strength of the solution used, of course, governs the shade or color.

Potassium Permanganate—This is one of the most useful chemicals for the beginner. It was one of the first chemicals I began to experiment with to produce a Circassian effect on common walnut used on factory arms. It comes in violet crystals and is to be dissolved in cold water. The colors resulting from its use are beautiful transparent nut-browns; when a saturated solution is used, it is possible to stripe and zigzag the solution on the wood, and when finished you will have an almost

unique effect. The stronger the solution, of course, the darker the brown color will be. Two coats are needed for a very dark stain. Another method I have used—before staining the stock—was to cut strips of paper out in odd forms in the natural form of the grain. These were pasted on the surface of the stock, running lengthwise with the grain, and the entire stock stained with one or two coats of the solution. The strips of paper are used as a mask, and also produce a unique effect where they have been removed. This method may be used when wood is void of figure or character.

The foregoing are the main chemicals used on stock work. Others, such as hydrochloric acid, picric acid, sulfuric acid, copper sulfate, potassium chlorate, sulfate of iron, and chlorid of iron, all produce different colors, but the formulas most useful for the stock maker follow.

FORMULA No. 8. STAIN FOR MAPLE

60	c.c.	nitric acid
200	c.c.	distilled water
10	c.c.	tincture ferric chlorid
50	grains	fine steel wool, free from oil

Put steel wool in a bottle and add the nitric acid, which causes a violent reaction. After the acid consumes the steel wool, add the other ingredients. To use, saturate a piece of cotton with the acid. Rubber gloves must be worn when applying this solution. Rub over the entire stock. If the first application produces the desired results, have a saucer full of strong ammonia (28 per cent gas) at hand. Saturate with cotton and rub over the entire surface to neutralize the acid. Allow to dry and refinish the surface to a light polish with rottenstone. Then give the stock either an oil or French polish. If French polish is to be used, one coat of raw linseed oil may be used with more satisfactory results. This formula gives a very beautiful yellow stain to the wood.

FORMULA No. 9. STAIN FOR MAPLE

5	c.c.	tannic acid
95	c.c.	distilled water
3	c.c.	pyrogalllic acid

Mix and apply the same as Formula No. 8. After the wood is dry, use ammonia to bring out the brown stains and at the same time neutralize the acid. You may find it necessary to vary this formula to obtain the desired shade of brown. You will learn this by experimenting with sample pieces of wood.

Copper Sulfate—When dissolved in water, it makes a stain which colors some woods jet black and some gray. The color penetrates deeply and is permanent.

Potassium Chlorate—Dissolved in water, it makes

a stain which colors some woods jet black and some gray, or produces a weathered effect. The color is permanent and penetrates deeply.

I have only used these last two chemicals to experiment with; they are two of the common chemicals used in different bluing solutions. A student may find uses for them on some classes of wood, and it will be well to carry your experiments further, perhaps making a formula which will become very useful.

FORMULA No. 10. CHERRY STAIN

½	oz.	lye (strong)
4	"	annato
2	qts.	distilled water

Boil until the annato is dissolved, and add the ½ ounce of lye. This formula is used for light-colored wood. Brush on while hot, using one or more coats and letting each dry before the next application. Use finishing treatments as given in Formula No. 8.

Light walnut, or even an expensive blank, may be stained a very permanent and beautiful dark brown by exposing it to ammonia (28 per cent gas) in a closed box or cabinet. Suspend the stock in the center of the constructed cabinet or large card-board or wooden box, by means of a wire or heavy string. Stand saucers filled with ammonia in the bottom, close the box airtight, and allow to remain ten hours or longer. The fumes of the ammonia will change the color of the wood very satisfactorily. This method is valuable to know, especially if you have completed a carved stock; any other method of staining would raise the grain in the cuts, which could never be finished again. This formula never raises the grain of the wood the least bit.

Varnished Stocks—Varnishing is one of the most unsatisfactory methods of finishing any stock, and one which I cannot recommend when all these other well prepared formulas are given. If you want this type of finish, by all means use lacquer.

Lacquer Finish—This is one of the quickest methods known in stock work and can be used on the wood after the final rottenstone treatments are given, as the wood does not require any filler whatever or any other preparation. Lacquer must be applied with a sprayer or air brush. Place the stock between centers of the checkering frame where it will be possible to turn it freely when applying the lacquer. There are several brands of lacquer on the market, but Du Pont's clear burnishing lacquer is perhaps the best. A stock treated in this manner will dry very rapidly and can be used

one hour after the coats are blown on; the finish will be water-proof. Naturally it looks like a light varnish finish, but it is far superior. This finish is only recommended when a stock is wanted in a hurry. In time it will probably be removed and a real finish take its place.

Removal of Varnish—The beginner will find a considerable amount of this work to perform on old stocks and stocks on the commercial arms which have been shellacked or varnished. Varnish is largely composed of vegetable matter, hence it is easily attacked and destroyed by an application of either alcohol or alkali. Alcohol answers well for removing varnish from a stock, but its slow action makes it less desirable than other removers on the market; these, however, affect the new finish more or less, especially a French polish. True, alcohol affects the surface of varnish, as any one having spilled any on a varnished object knows; but that is quite different from eating through the heavy varnish on some old stocks; on a shellacked stock it is preferred.

The simplest alkaline remover may be made from a pound of sal-soda added to a gallon of water. This may be made stronger if necessary up to the point of a saturated solution. Apply freely, and while the surface is still wet, rub off with No. 3/0 steel wool. When finished, rinse, using plenty of clean water to remove the alkali. Follow with a coating of acid water to neutralize the alkali. Wipe dry with a clean, dry cloth, and let the stock stand until it is perfectly dry. Vinegar or ammonia made in a solution can be used to neutralize the alkali and does not have to be washed off, as it will do no harm. If the stock should be more or less discolored from the acid wash, and is not going to be stained, apply a wash of oxalic acid to bleach it.

Ammonia water may also be used for stocks. This is preferred to sal-soda as it evaporates and leaves nothing to injure the next finish. Also, if you should wish to remove old filler out of the wood, there is nothing better than ammonia, used with a stiff bristle brush. Ammonia is the only chemical that can be used on some of the Mannlicher stocks to remove the substance they apply for a finish. However, it will always be necessary to bleach the wood with oxalic acid as previously stated.

You can make a compound of two parts ammonia and one part turpentine which will, with shaking, form a permanent emulsion that can be used. When using ammonia, always procure the product containing between 26 and 28 per cent gas, as the common household ammonia is not suit-

able for such purposes. Nearly all removers sold are made from fusel oil or some such spirit bases and are highly inflammable. Fusel oil forms the basis of ether, guncotton, collodion, and banana liquid. It is a rank poison, and should be handled only by those familiar with it. It is a sure remover, and can be used in a variety of ways: for cleaning old paint brushes, removing tar, shellac, copal, varnish, lacquers, paint, etc. Some may wish to mix such a formula, so here is a sample mixture for those who can not secure the ready-mixed.

FUSEL OIL MIXTURE

4 oz.	benzol
3 "	fusel oil
1 "	denatured alcohol
1/2 "	camphor

Mix together, increasing proportion for large quantities.

The commercial removers should be used economically to avoid waste. This is the best way to use them on a stock: First, coat the surface all over with the remover, which is applied with a brush. Let it work a little while before trying it to see how it is eating into the old finish; if, in trying a part, it loosens up readily, it may be removed by scraping it off with an old knife; but if it does not loosen up readily, then apply another coat. The idea is to get the old coat soft by saturating it and softening it down to the wood, so that it may be easily removed by scraping and using No. 3/0 steel wool. After the complete removal of any varnish, shellac, or lacquer, the stock must be sanded and polished to bring out a high finish again.

Buffing-wheel Polish—We must always devise means to eliminate hard labor, especially on stock work. When an electric grinder is included in the equipment of the gun shop, this valuable addition is a means of cutting down hours of hard labor. It can be used not only for grinding, but for buffing a stock. The wheels commonly used are the 8-inch muslin sewn wheels, the canton-flannel sewn and the fine sheepskin wheels. Remove one of the emery wheels from either the right or left side, then screw the buffs in place. They come in thin widths; thus it is necessary to buy from three to four sections so that it will be possible to have a large surface to work with when it comes to the polishing operation. The new wheels are sewn from the center to the outer edge in a spiral. Before using these, the outer thread must be removed so that the layers of cloth can be spread apart when pressure is brought against them in the act of

polishing. A description was given in the first part of the chapter of the wheel as it was used for the rottenstone treatment. Now we use it for the complete polishing of the oil finishes, and also in the treatment of the polishes used after the oil finishes have been built up by the buff method. It is impossible to eliminate the hand rubbing entirely, but we can produce a finer surface finish than we could by applying the rubbing alone.

Select an oil formula you wish to use; apply the first coat in the usual way, rubbing it on with your hand, as previously described. Then apply the same oil very sparingly to the face of the buff, either muslin or canton flannel. Start the motor, and with a flat clean hardwood board, gently press against the surface of the revolving wheel until the oil is evenly distributed over the face of the buffs. Let it remain thus for eight hours, and also let the stock stand for the same length of time before the buffing or polishing operation is begun. Do not apply too much pressure on the wheel, but press the stock against the fast-revolving surface gently, lengthwise to the grain of the wood wherever possible. Stay away from the checkering, and when it is necessary to polish in sections where checkering is used, use the edge of the wheel. At times you will find that it is impossible to follow the grain lengthwise—around the pistol grip or cheek piece, for instance. You must then polish in the general direction most practical. Be very careful when coming up to any sharp edge of a cut-out,

such as the magazine or receiver section, that you do not break the edges of the wood, or come over the center of the wheel, allowing it to catch and jerk the stock out of your hand, which may injure it beyond repair. After completing the polishing (your judgment must determine the time), put the stock in a dry place for two days and repeat the operation. Do not apply any more oil to the buffing wheel, for as a general rule the remaining oil in the cloth is sufficient to last about one week before any more is needed, and then only a few drops will suffice.

The time required to complete an oil finish by this method can not be given, tho it takes less, and far better results are produced. After completing the polishing with either the muslin or canton-flannel buffing wheels, apply the final finish with the fine skin wheel with the wool on the outer surface. Apply a few drops of the stock polish to the surface and gently press stock against the wool as the wheel revolves. This brings out a very fine luster on the surface.

The checkering or carving of a stock is always done before the finishing oil is applied, and when the checkering is finished, one application of raw linseed oil is brushed in with a tooth-brush and allowed to remain thus for one day before the finishing oil is applied. This gives it time to soak well into the wood, and no further applications are necessary than the one coat of raw linseed oil.

The finishing of gun stocks is an art in itself.

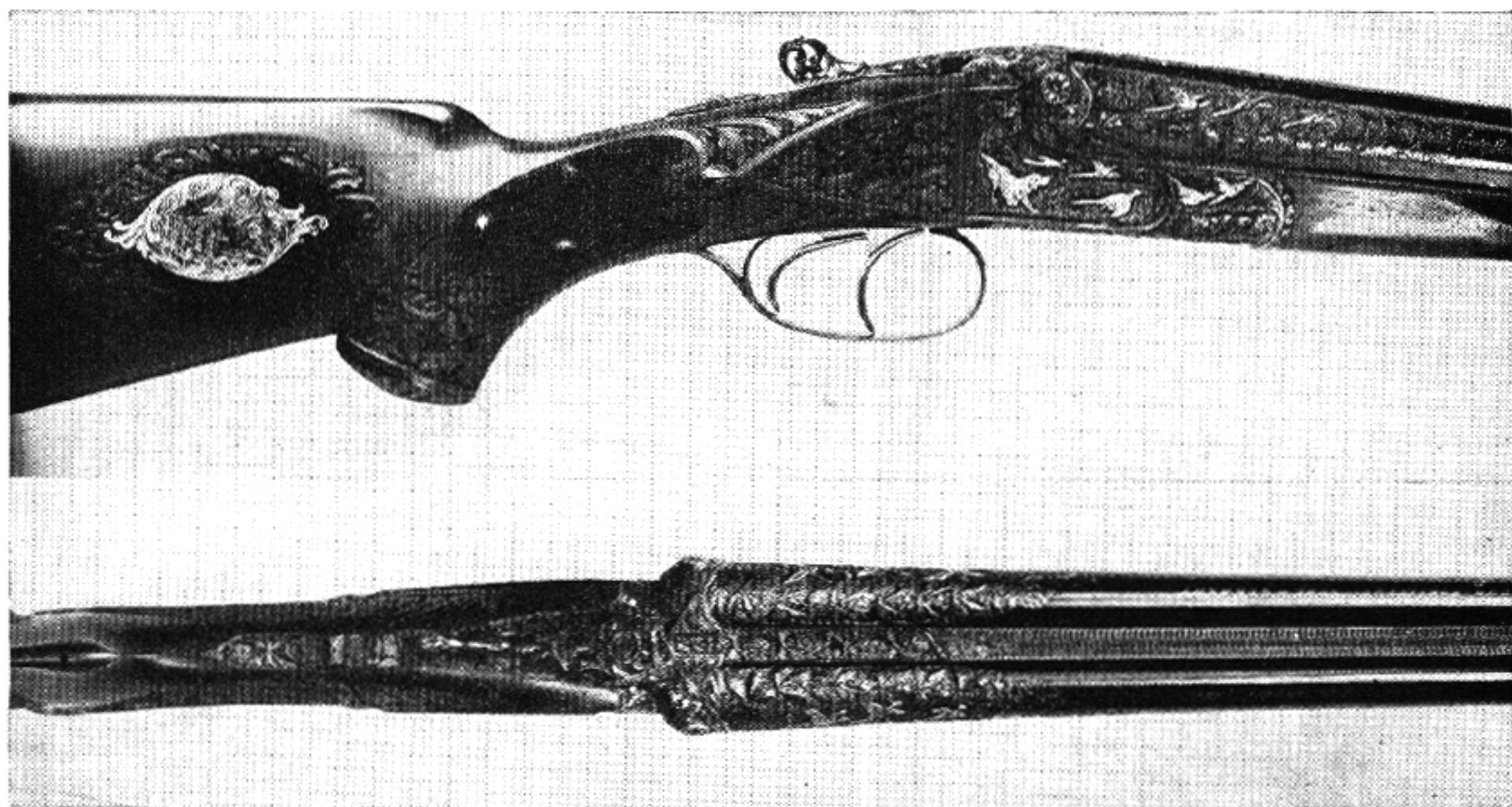

Fig. 86

Beautiful example of the gun maker's art. By V. Chr. Schilling. An object of perfection

It makes little difference what kind of wood you use. Modern methods will develop finishes that are truly beautiful, and they call for the complete knowledge of the characteristics of the wood you are working with.

It is characteristic of the members of the present generation that they must have things placed before them in such a complete manner that very little effort is required to solve any problem. Stock finishing is an art of a technical nature, and the knowledge to be gained from this chapter only touches the surface of the possibilities that may arise in the future. I have cited materials and methods which produce finishes equal to the present-day demands for practical and artistic finishes.

Nature has not been as kind to some woods as to others, just as she has neglected some women and heaped her blessings on others. However, she has in most cases balanced things in some way, so that these unfortunate objects have other charms which more than make up for their deficiency in beauty. We have noticed that many women who are naturally beautiful destroy their natural charm by trying to make themselves even more beautiful with the aid of various artifices. It is possible to do this same thing to a beautiful piece of wood. Figure 86 not only shows artistic beauty in the engraving and carving, but also natural beauty in the wood itself, as an aid in keeping with the designs on the metal parts.

CHAPTER XIII

Checkering, Carving, and Inlays

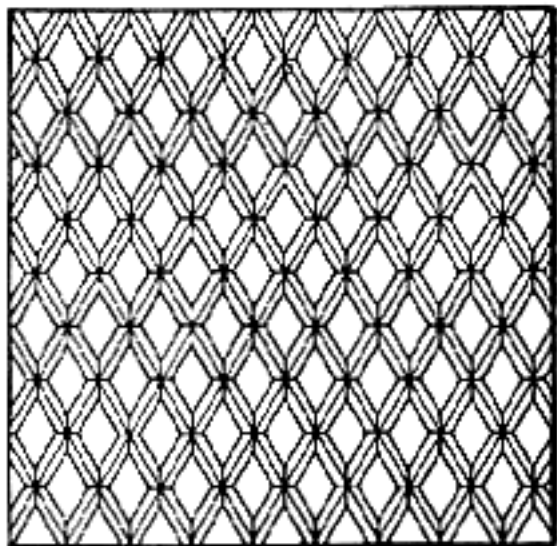

Checkering, Carving, and Inlays

BEFORE the amateur attempts to checker a new stock, he should diligently practise until he feels capable of reproducing as nearly as possible a perfect execution of design. It will prove fascinating, and if you are the type of person who takes joy in seeing his hands perform artistically, I need say nothing further about constant application. Checkering forms a very appropriate means of decoration on a gun stock, but its main and practical use is to give the hands a better grip. It is especially useful when the hands become moist from perspiration. The appliances used are a cradle to hold the work; checkering tools, which consist of border, matting, and beading tools; flat chisels, and a three-square needle file. Contained in Chapters I and II are descriptions of these tools, stands, and frames.

Checkering is an art of the gunmaker's trade requiring the utmost patience, concentration, and perseverance to learn. It is much the same as engraving, tho far less complicated. If I have seemed discouraging, do not be bothered, for I have examined many checkering designs executed by students that were as fine as professional work; those which were good revealed the calm disposition of the artists who used deliberation before cutting each line. A nervous type of person who tries to finish a job in the shortest possible time produces failure.

A well checkered stock should be in harmony with the body outlines, and where there are points, have points on the opposite end or forearm. Points should match on the front end of the design on the pistol grip, but at the rear of the checkering the border should form a neat curve in line with the body curve of the stock. All other lines should be made so that a pleasing effect is produced throughout. Do not make harsh or broken lines, or place radii where they should not be. When laying out these lines, gracefully terminate them at a point either on top or bottom. Draw a number of designs out on the drafting board until you find one suitable for the stock you intend to checker.

Old stocks which have been discarded, say from old military arms, can often be a means of im-

proving your ideas, of which width of checkering is the most appropriate. When checkering was first placed on a stock the lines were as much as $\frac{1}{8}$ inch apart or more, which is eight lines to the inch. Some had very wide lines, as much as $\frac{1}{4}$ inch apart, with two finer lines, and in the center of the diamonds a bead was formed. This type of checkering is usually found on muzzle-loading shotguns and dueling pistols. The student can copy these on a Springfield, Krag or Enfield stock, using his own particular methods, even tho the design is filed in with a three-square needle file. I would suggest Figure 87 for practise.

Since the pistol grip is the most difficult part to lay out, we shall start with this. Figure 88 illustrates various designs; I would suggest No. 1 to begin with, for this is the plainer type. When this is completely drawn on paper, compare with the grip for correct size, and see that all lines are in exact proportion. If you are satisfied with the design in every detail, paste it on thin cardboard or heavy paper and cut out. This pattern may be used either for the right or left side of the pistol grip by reversing the pattern.

Place the pattern in position, and with a sharp lead pencil make lines all around the outside. When you begin laying out this design, the two lines which formed the V were constructed so that they formed a well proportioned diamond. When laying out a diamond, use a center line; the correct angle is 15 degrees on a side or 30 degrees included. This rule is only true on a flat surface, so in the design of diamonds for gun stocks we must disregard this rule and lay out the diamonds so that they will come as near to a sharp point as possible in the beginning. When you checker around the curved surfaces, the long pointed diamond may be lost and look rather square before the checkering is finished.

For the design laid out in lead pencil, you will need either a 12-inch flexible scale or a $\frac{1}{64} \times \frac{1}{2}$ -inch piece of finished spring steel, the length being about 15 inches. This is used to carry out long lines, and since it is flexible, it will be possible to carry out the lines on a curved surface. With the rule, extend the lines out from the V to the bor-

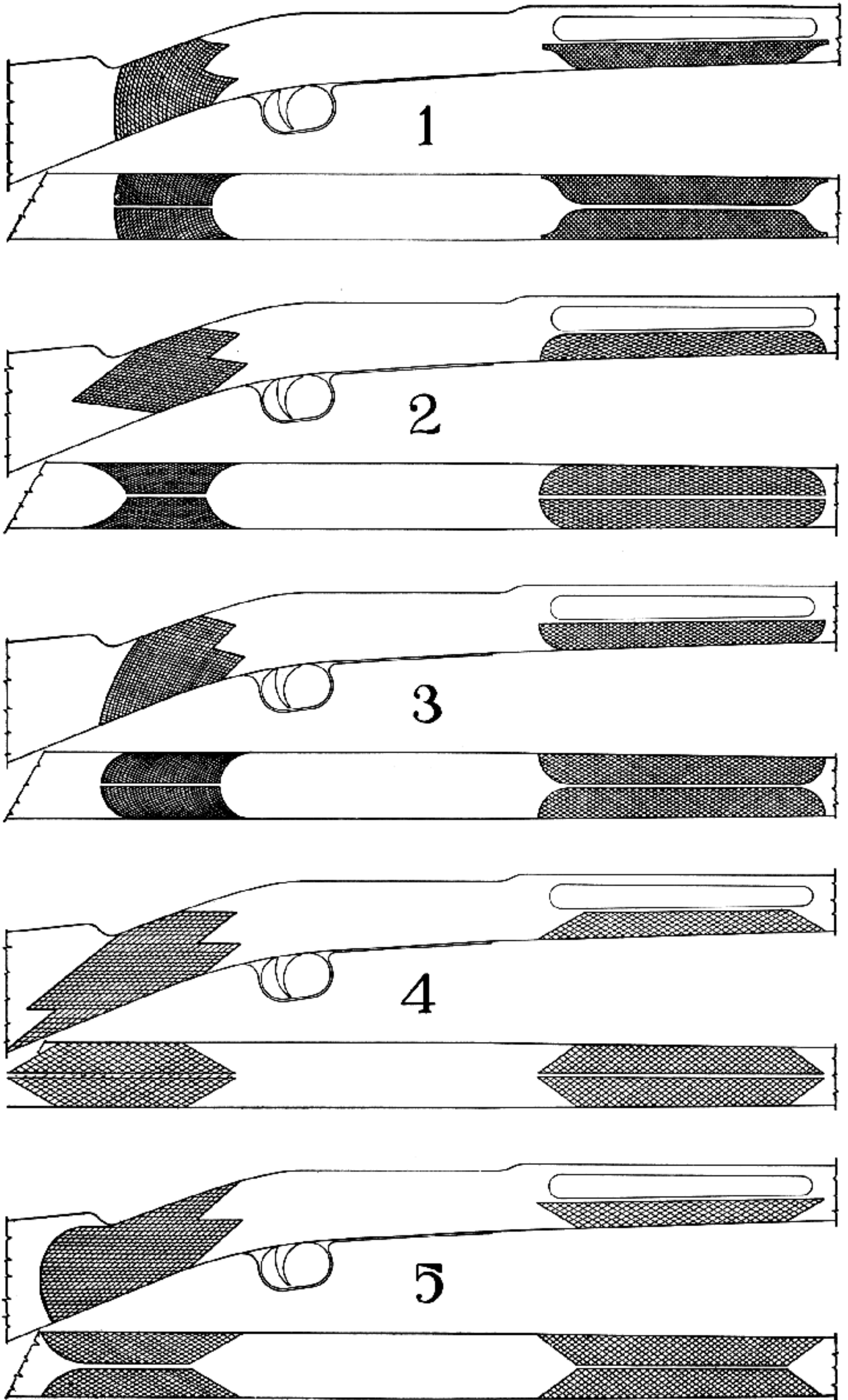
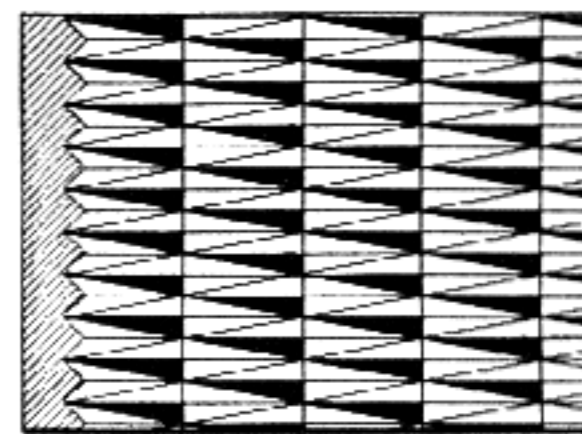
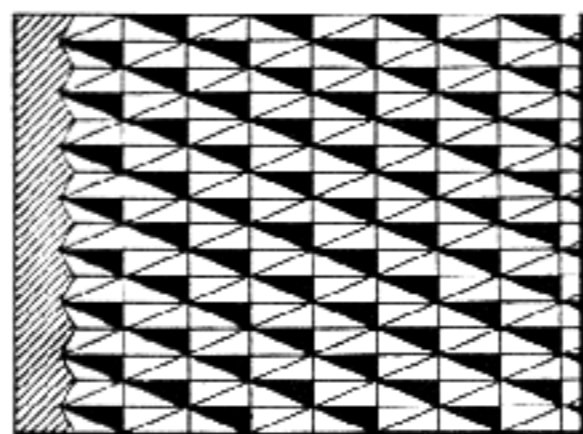
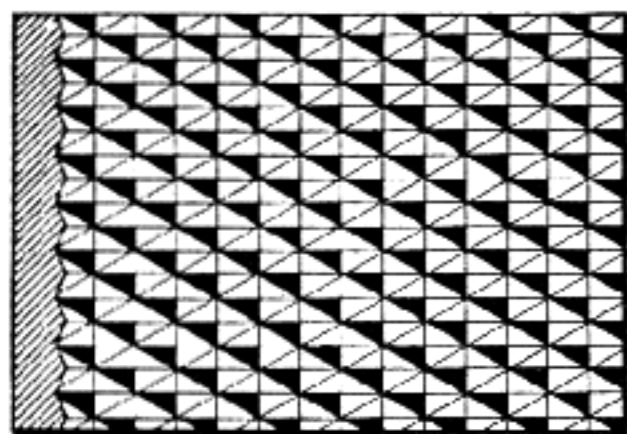
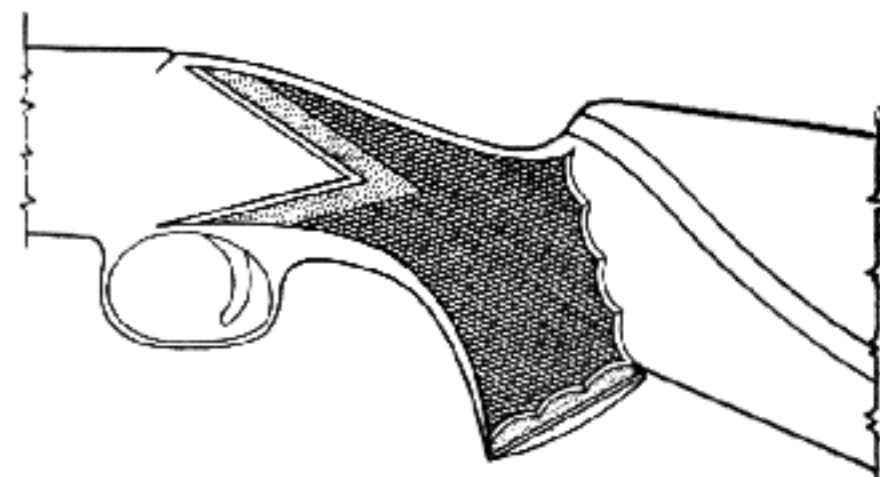
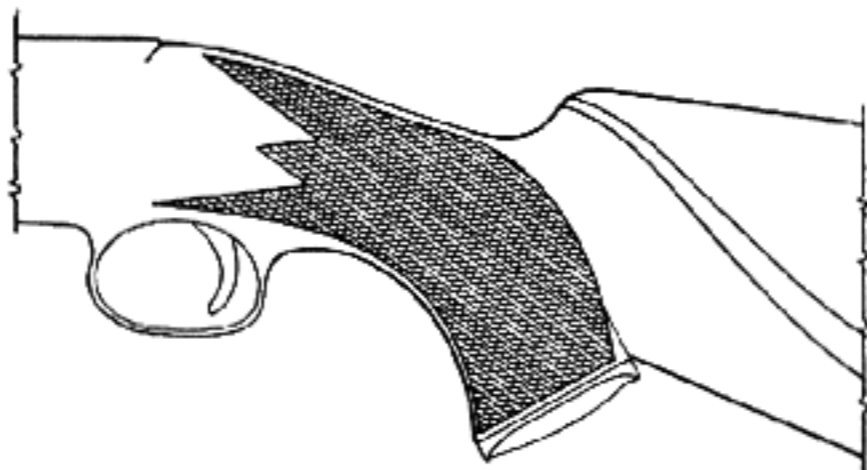
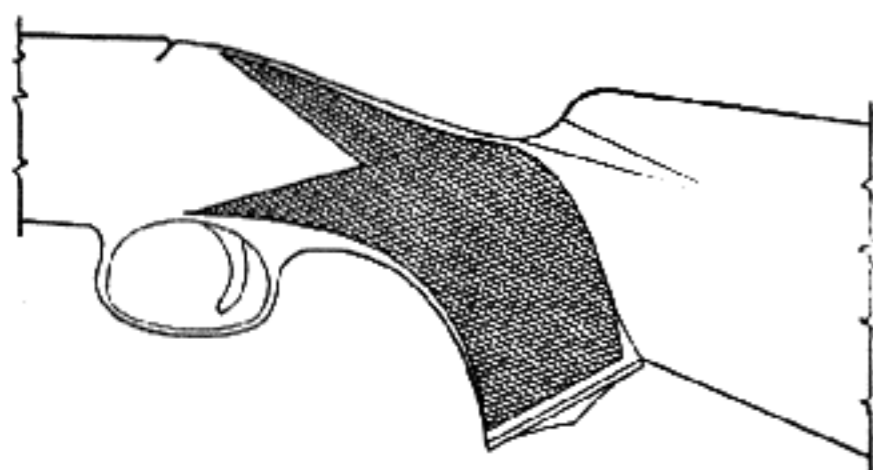

Fig. 87

Simple checkering designs—suggested for an amateur's first attempt on a military stock



DETAIL OF 60° CHECKERING

DETAIL OF 45° CHECKERING

DETAIL OF 20° CHECKERING

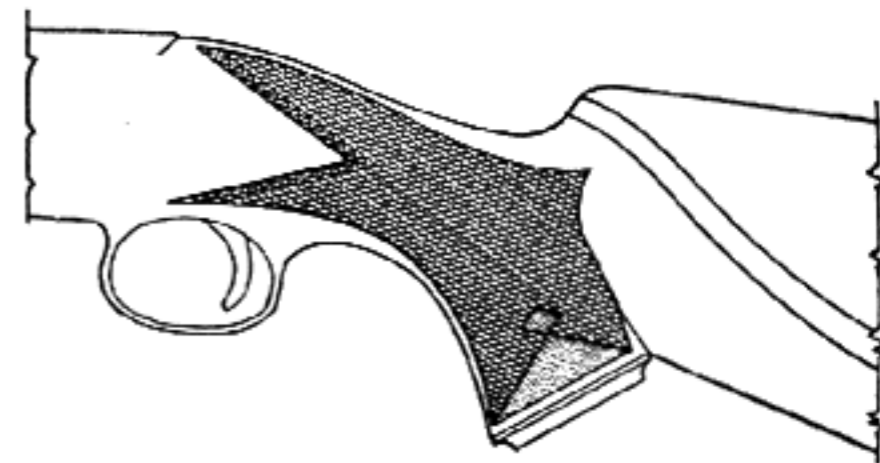
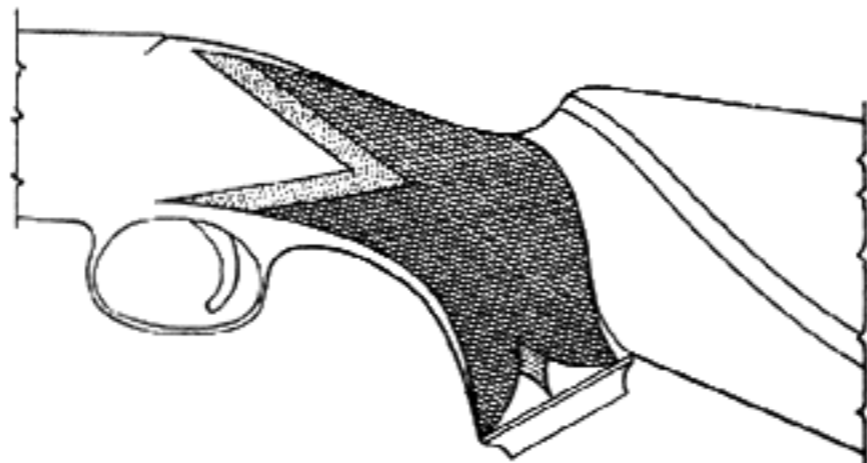
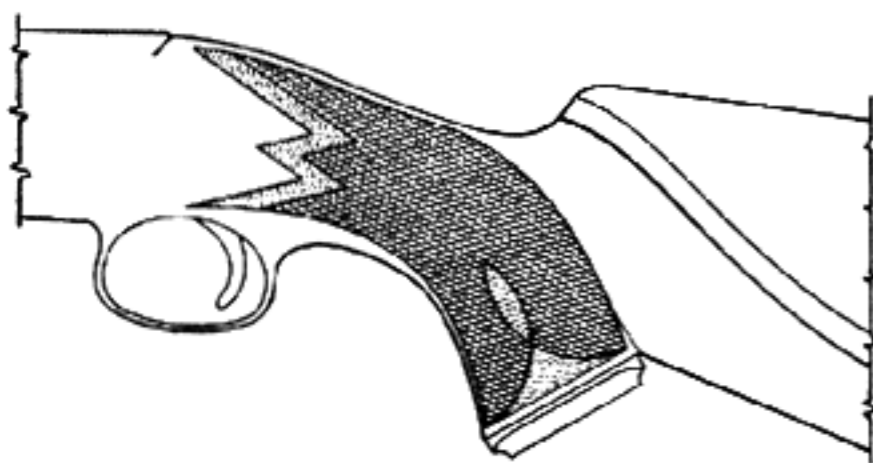
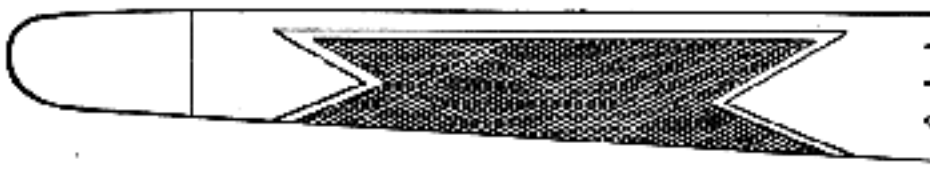

Fig. 88
Pistol-grip designs



NO 1 SIDE



NO 1 BOTTOM

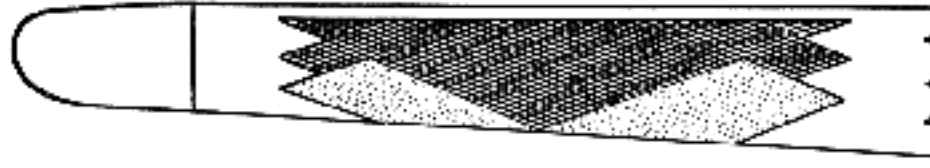

NO 2 SIDE



NO 2 BOTTOM

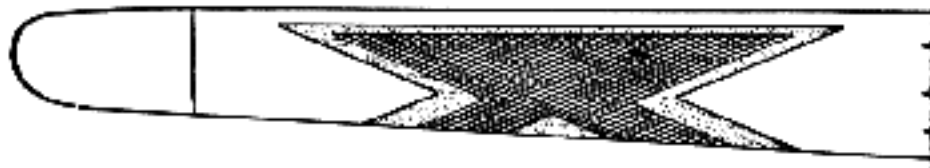

NO 3 SIDE

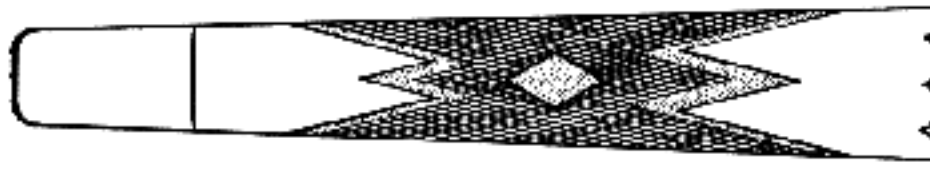

NO 3 BOTTOM

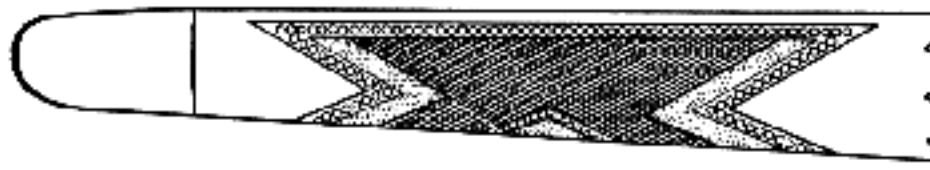

NO 4 SIDE



NO 4 BOTTOM

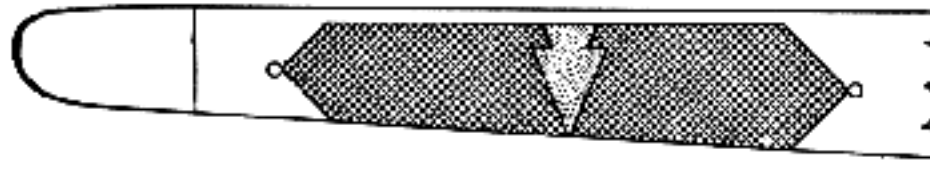

NO 5 SIDE



NO 5 BOTTOM

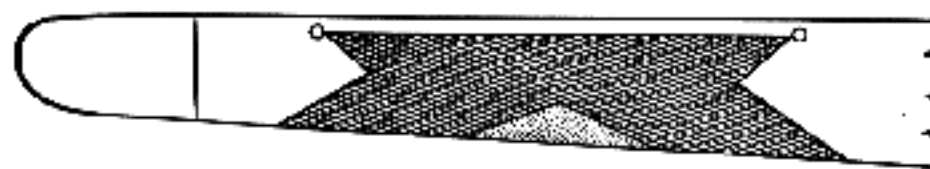

NO 6 SIDE



NO 6 BOTTOM

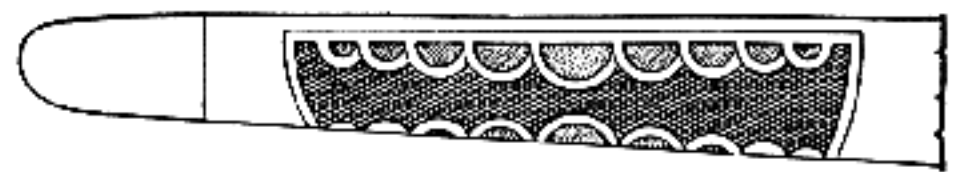

NO 7 SIDE

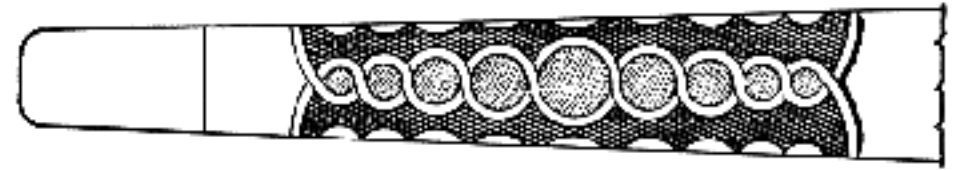

NO 7 BOTTOM

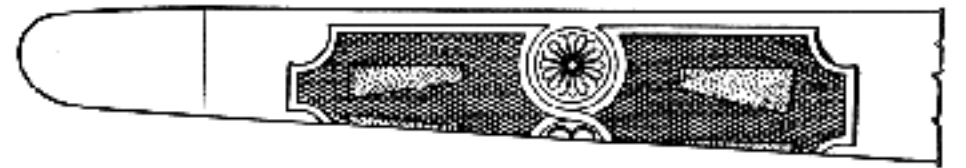

NO 8 SIDE



NO 8 BOTTOM

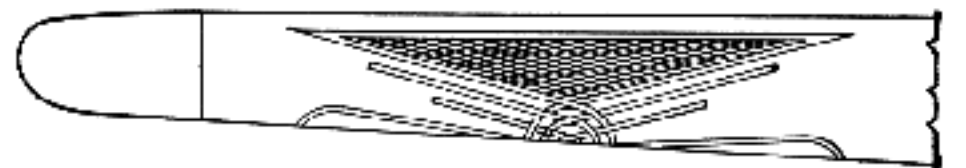

NO 9 SIDE

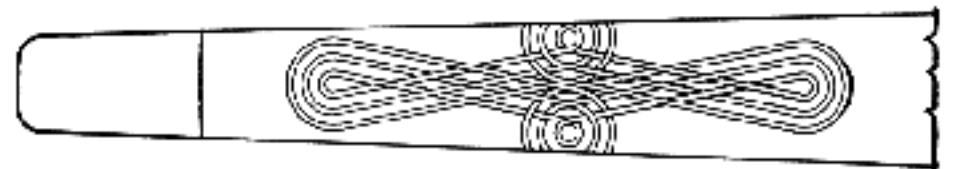

NO 9 BOTTOM

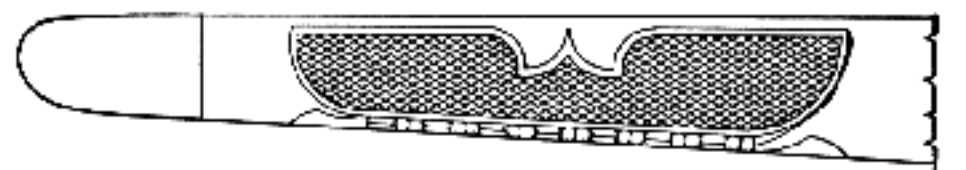

NO 10 SIDE



NO 10 BOTTOM

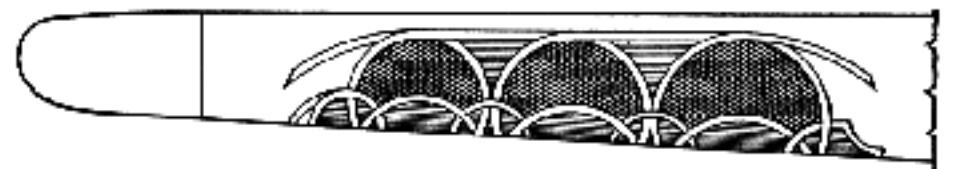

NO 11 SIDE



NO 11 BOTTOM

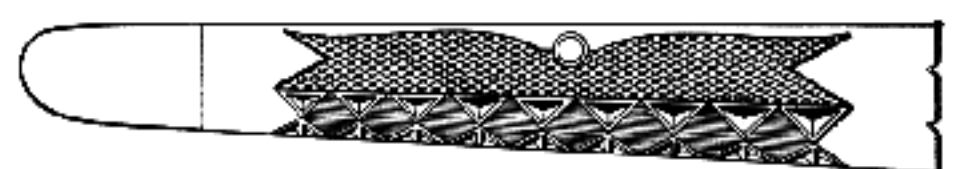

NO 12 SIDE

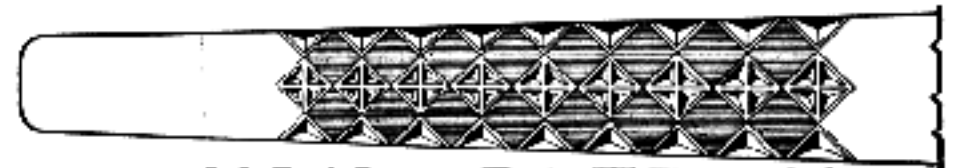

NO 12 BOTTOM

Fig. 89 Forearm checkering designs

der. Mark out the pencil lines with a bent needle file or the starting tool which is shown in the set. After you become familiar with the three-square needle file, continue its use instead of the starting tool, for with it you can make very delicate lines and follow sharp curves with less difficulty. When the outlines are filed on the sides of the pistol grip, you are ready to checker; but before this we shall lay out the lines on the forearm, using No. 1 design in Figure 89.

There are a number of different designs to consider, but we must select No. 1 because it matches No. 1 on the pistol grip. Measure from top of the barrel channel between $\frac{1}{4}$ and $\frac{1}{2}$ inch according to the border you wish to use, and with a pencil, establish the length of design. This must be of an equal distance between the fore-end tip and magazine tang. For an illustration, let us say that you have placed the line ahead of the tang one inch; then you will place the forward line one inch back from the buffalo-horn tip, and the distance between will balance the checkering very nicely. This rule may be disregarded when special designs are used, but it is a convenient way of holding the center of the forearm. With the two top border lines laid out, establish the bottom center line, which must be straight between the tang and center of forearm tip. When six points are established, three at the rear and three at the front, lay out for the diamond, starting from the rear. Before doing this, check the difference with dividers between the center line on the front and the border; also at the rear. Since the forearm is tapered, the first measurement will be much less than the rear, so we must allow for this difference, thereby lengthening out the line from the border to the forward center, which will be three times the width of the diamond. Thus the top line will be ahead of the bottom line, which is the difference between the front and rear measurement. To come out even on the forward point, as you begin to checker from the center to the border, length is always lost because of the curve of the forearm. To avoid this, as you finish up at the front, establish the

forward points so that they will be neat and even.

As an illustration for this lay-out, suppose the difference between the two centers is 1 inch and the length of the design on the forearm is 6 inches; to have the diamond come out three to one it is necessary to place the first line ahead $4\frac{1}{2}$ inches on the center, and the line on the border $3\frac{1}{2}$ inches. You will find that when the lines are crossed and connected, the front V will come out evenly.

Gently tap dental burrs which have been ground to a point, or pins, in the centers. Six will be required—three at the rear and three at the forward lay-out. Stretch a piece of music wire measuring $\frac{1}{64}$ inch in diameter, or a trifle larger, between the pins as Figure 90 illustrates. By drawing the wire taut, it will give a true straight line over a curved surface. With a very light hammer, gently tap the wire and make an impression in the wood which may be followed with the bent three-square needle file or starting tool. Another method often used is to chalk a piece of string, tighten it between the pins, and gently tap the string for an impression. The wire is more reliable, for it follows curves much better than string, and makes a truer impression. The flexible scale or rule is used for the border and center lines. After the lines and borders are laid out, and lines are either filed or established with the starting tools, the checkering is begun.

Practise—Before checkering a new stock, first do a considerable amount of practise. When you have completed laying out your first simple design on the stock, you will be tempted to start checkering immediately; but it will be far wiser to do a similar piece of wood, such as the forearm, checkering this part first since it is more simple than the pistol grip. Form the sample piece of wood so that it will be possible to place it between the centers in the checkering frame and lay out the same lines. Select a wide spacing such as .050, .06, .07, .08, .09, and $\frac{1}{8}$, which give between eight and twenty spaces to the inch. The gunsmith will have a number of double-spaced checkering tools

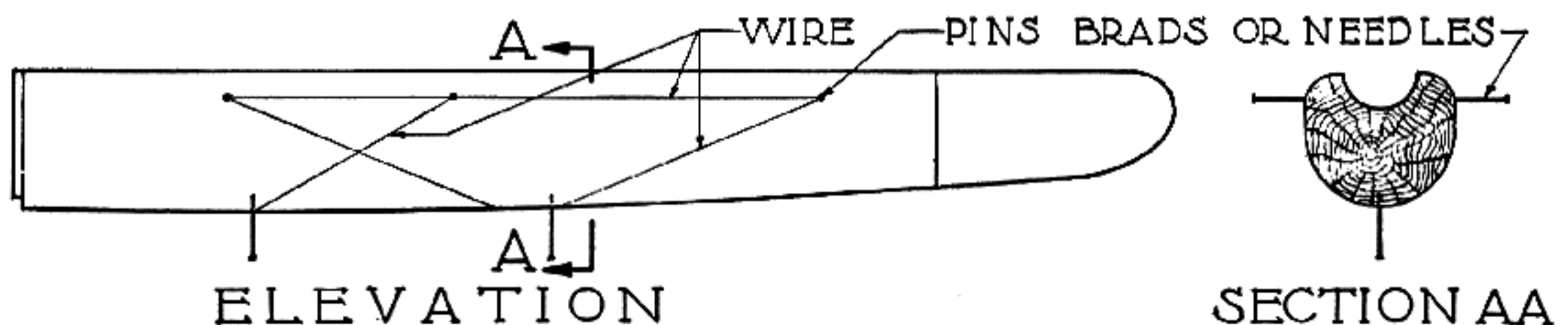

Fig. 90

Laying out a checkering design. The pins are in position to stretch the wire or string so that master lines can be penciled in

that produce between sixteen and twenty-eight lines to the inch. When the spacings reach above twenty-two lines to the inch, great care must be exercised to make all lines come out evenly and straight.

You will find that a checkering frame or cradle is just as important as the tools; the stock is continually being turned between center, as it is checkered. There are different ways of making a checkering cradle, but Figure 26 illustrates the correct way. In Chapter II two simple models are described. These may be held in the vise; however, if you do much checkering, the standard cradle will be the most convenient. The simpler models are made of any 2 x 4-inch wood; they are only temporary and can be made very quickly. When it is necessary to adjust for distance, remove the wing nuts and place the bolt in one or the other bored holes. The cradle is set in a convenient position in the vise and the stock set between the centers. A round piece of wood is made for the barrel channel; two wood screws fasten it in place. This is the forward center; the rear screw finds a place in the butt end of the stock. The two set screws should be tightened so that you are just able to turn the stock by hand, and so that there will be no vibration when the pressure of the tools is used. Figure 8, Volume II, illustrates an all-steel checkering frame and stand, one of the most improved cradles for this purpose. A full description of this accessory is given in Volume II.

With these preparations made, and with the sample test piece between the centers, begin checkering. Start from either the center or border line, and follow the border line, holding the tool on a slight angle so the first row of teeth will set well into the line. Continue this cut to the border, and as you push the tool forward in the border line, work it back and forth as you would a file to remove burrs from a thread, but advance about one to two inches each time and return to retrace the previous impression. Hold the handle in the palm of the hand and use the index finger as a guide on top. If the eye detects any running off from the straight line, let the tool follow the groove with the eyes directly behind the work so that it will be possible to keep your hands well in front of you. It is not necessary to make the grooves full depth at first; it will be much better, as a beginner, to make these lines only half the depth and then come back when the checkering has been gone over both ways, and finish to the full depth. As the border is neared, work very carefully and only come up to the edge of the line. Large borders are usually placed on checkering to cover up these runovers. The best checkering does not

have any border except the one-line, ornate type which is beaded or carved.

Now go back to the starting point. You have three lines on the wood which the tool made; move over one line and leave the other two as guiding lines. While the outside row is cutting, the other two are following and finishing; when you become experienced you will be able to complete the grooves to the full depth and the file will have very little to finish. As the tool raises the dust from the wood, always keep it blown away by a sudden puff of breath, and when one or two lines are finished, remove the remaining dust with a heavy bristle toothbrush. Continue line after line until you have completely covered the design in one direction.

On completion, cut the cross lines the same way, using even greater care not to pull any of the diamonds out. After this is finished, begin over to deepen the lines until the diamonds are sharply pointed. Make every cut the full length of the lines. The forward end of the design where the checkering ends will be the forward V. These lines are dotted on the drawings, which means that they are to be finished later; or the lines terminate, and for that reason never work these in, but always let the checkering do that. If at any time you should work from the front, let the checkered lines terminate the rear V. When the two ends are laid out, the checkering never comes out just right, and you find yourself in a discouraging dilemma. It may be well then to practise straight lines such as Figure 91 shows.

The guiding of a checkering tool requires much practise. As advised before, slightly tilt the tool on the first line to follow the border line. After the first line is completed, keep the tool straight. As the tool is held in the palm of your hand and the index finger is on top of the tool, this should work in unison with the bone of the index finger and the elbow when the tool has a tendency to work to one side. These bones are not in a direct line with the lines on the design, and when the tool is so tilted and begins to ride the sides of the groove, it will be sure to jump over into the next line, a line which can never be brought back again.

The grain of the wood also has much to do with straight lines, and at times you will strike a soft spot which the tool will have a tendency to follow. Care and special attention must be paid to such conditions. American walnut is the most difficult to control in this respect. Foreign woods are the finest to checker, for they are very even in their fiber structure.

Having finished a sample of the design you are about to checker, it will be well to experiment on an

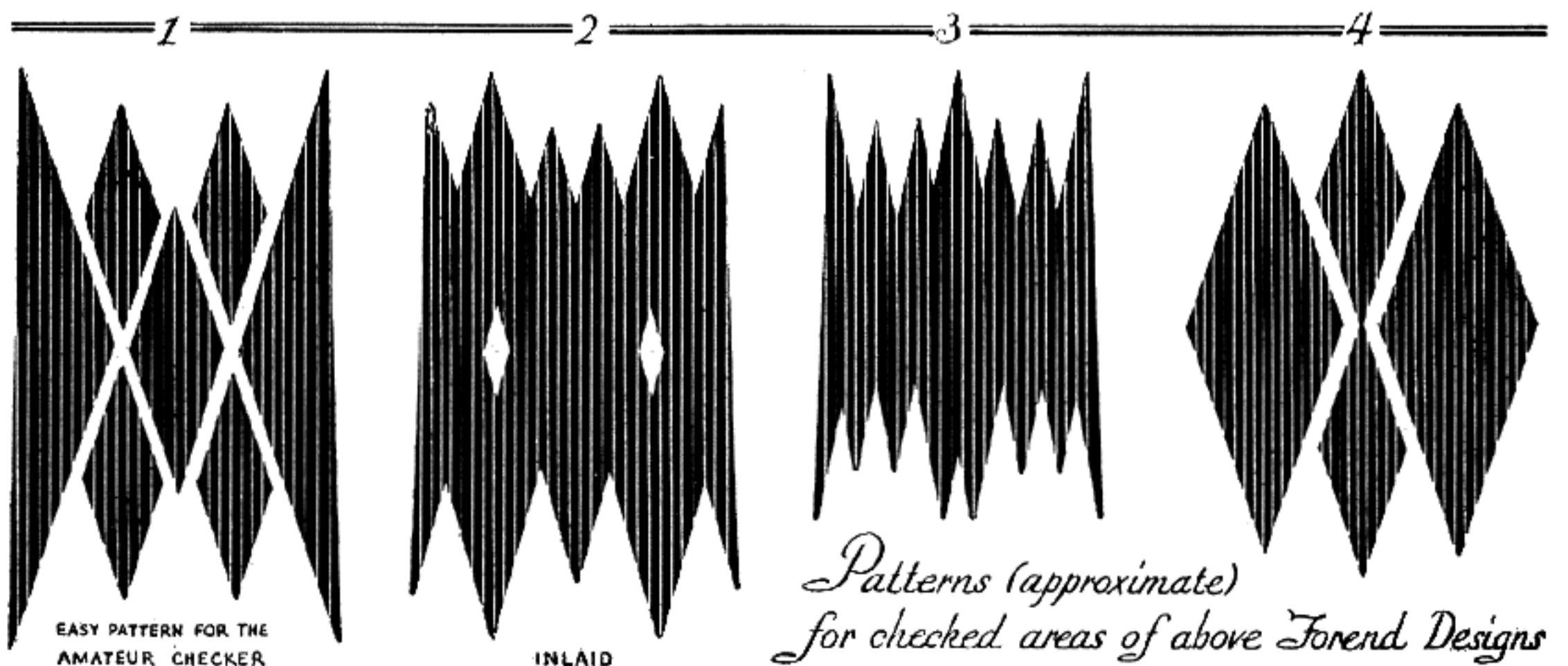
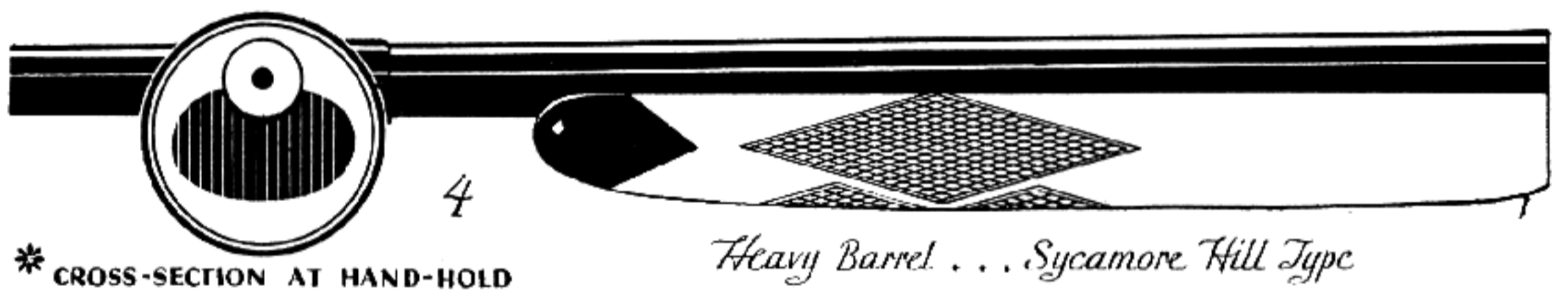
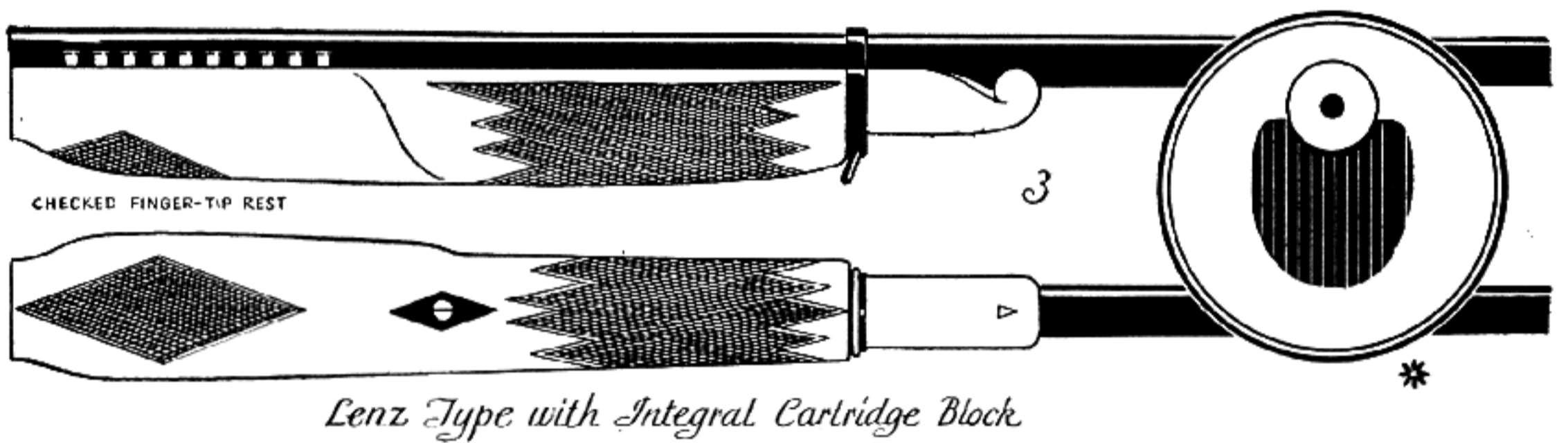
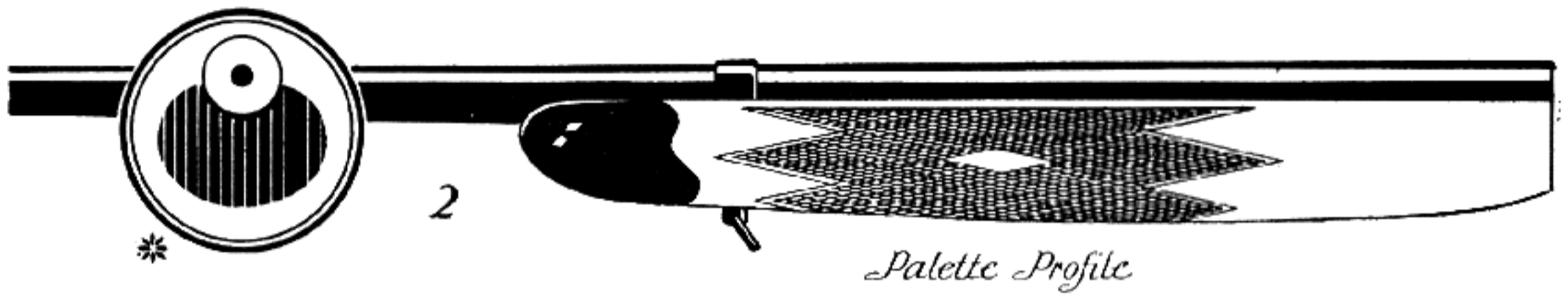
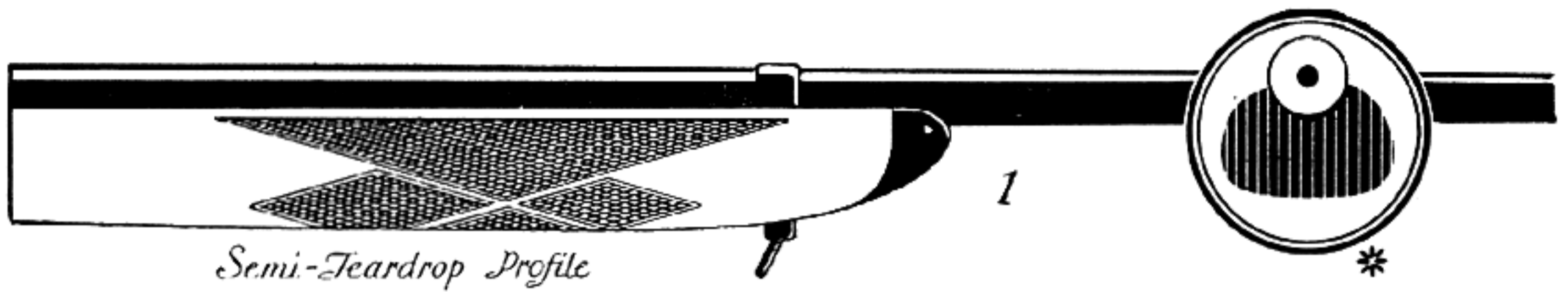

Fig. 91 Forearm checkering designs for single-shot rifles such as Winchester, Ballard, Stevens, etc.

old stock on which the checkering has been well worn off. Even if the diamonds are worn off you will still be able to find the outlines. Make a tool the same width and retrace the old lines, bringing them out sharp again and deepening the borders. If they have just the plain V on the ends, place a checkered center V out to the end. Always plan to put on a little more design if it is plain. Such practise will help you gain much valuable experience.

Checkering the Forearm—With the experience you have acquired on the sample piece, it will be comparatively easy to checker the new stock. Begin with the tool as before, continuing to the center. Now that you have become accustomed to the handling of the tool, do not become careless, but be meticulous in every move. Complete the lines in one direction, only passing over the surface to half the depth of the tool; then complete the cross check in the same manner.

I believe that it will be well to go into the proper performance of tools at this point. A hard wood requires tools with sharp cutting edges; not necessarily a keen edge, but just so the wood may be removed without tearing softer spots as in American walnut. Tools that are too sharp are just as detrimental as dull tools. Tools used for this wood alone will perform much better if the cutting edges are made with a burnishing effect to scrape instead of cut. To have a perfectly sharp checkering tool, keep a fine three-cornered oilstone handy to preserve the required cutting edge for the wood you are using. When the regular V-tool is used, both outside edges are cutting. This type of tool is more difficult to use at first, but after sufficient practise very good work can be done. The double-V tool does the best work, for it guides in two lines; while the outside line is cutting, the inside line is finishing. A set of checkering tools will last a number of years if the proper care is given them.

With the lines only impressed to half the depth and the tools stoned to suit the wood you are using, you may complete the cross checkering. Be very particular not to have the lines run narrow to the border and then die out, for this spoils a checkered stock. Straighten out the lines with the needle file.

You will experience considerable difficulty in the corners and close to the borders. Do not try to use the tool when you come to those places, but finish with the bent-needle file. On curved lines, do not come too close, but let the file do the finishing, for you can control this much better than with a tool.

Chapter I describes the methods used to bend

the three-square needle file. If this is used with too much pressure, it will snap off at the end, so use it very gently as you file out the grooves, raising the diamond to a sharp point. File up to the border; this was neglected with the tool, so you must go back and forth in order to bring the diamonds up sharp. Keep the dust well brushed out, and if the wood has a fuzzy appearance, use No. 3/0 steel wool and brush over the checkering to remove this; then brush out with the toothbrush. It has often been recommended to use a little raw linseed oil when checkering; but never place any oil on the stock at this time, for then the tools will become clogged, especially the file. When it is necessary to use something to hold down the fuzzy appearance, use shellac lightly brushed into the checkering. If you have completed the filing and the checkering appears well defined, use a small piece of No. 3/0 steel wool, and gently brush out the entire design to make the diamonds look clean and sharp.

If you wish to have a border, go around the entire edge with the V-tool, and with a thin, wide, sharp chisel cut thin shavings on an angle to the checkering. Brush out with fine steel wool, and see if there have been any points overlooked. Finally, give the checkering a coat of raw linseed oil, working it in with a stiff-bristle toothbrush.

Checkering the Grip—There is one point which I failed to mention, and that is never to checker back of the tang of the receiver. Most men use the thumb over the grip, and a checkered surface will injure the skin when a number of shots are fired. It looks well but is entirely out of place, for this must essentially be a smooth surface. The border lines can follow the tang in about $\frac{1}{16}$ inch on both sides and then start down with a graceful curve. The under side of the grip is another place where checkering should never be unless it is a military stock, for you can never connect the lines from right to left; they have a tendency to change so greatly around the curve that they would come out round instead of lengthwise. Always carry the line from the edge of the trigger guard to the edge of the grip cap and then bring it in $\frac{1}{16}$ inch on both sides. The line which is drawn from this point just clears the tang of the guard or comes near enough for a border up to the tang, extending forward to a suitable length.

In checkering a pistol grip, the method of working the tools is similar to that used on the forearm, except, of course, that you will experience more difficulty than on the forearm because of the curves. The first lines to start are from the rear

of the cap to the receiver—lengthwise lines or lengthwise to the grip. The straight lines follow the stock lines or grain of the wood. Cut all the straight parallel lines back from the V; then cut three or four lines crosswise, and complete the straight parallel lines. Start the cross-lines after completing these. This is where the curved surfaces come in, and you will experience some difficulty in keeping the lines straight and in alignment because of the curve. At times it is only possible to cut three or four lines one way, especially when the lines come close to the grip cap. Change positions first in one direction and then in another. Keep the lines free of dust by blowing it out with your breath. After you have checkered for a while you will do this unconsciously. Watch the lines very closely, first from one direction and then the other, and constantly keep the tool lined up with the eye. Make due allowance for corrections and always keep the lines straight as they continue over the curved surface.

With the three-square needle file bring the dia-

monds up sharply as you did on the forearm. Use painstaking care on the border and in the sharp corners; bring them to very sharp points, and when completed go over the entire design very lightly with a small piece of No. 3/0 steel wool. This polishes the diamonds and makes them appear much sharper.

Cut out the border as you did on the forearm with the thin flat chisel. Finally, rub raw linseed oil into the checkering with the toothbrush, and allow it to soak into the wood; this will require about ten hours. Wipe off any surplus oil which may run over the surface. After ten hours, apply another light coat of oil—also on the forearm. Do not allow any of the oil to build up in the checkering, for it is rather difficult to remove when once hardened. Two or three coats of oil are sufficient. Then the final finishing takes place.

Border Design—A well designed border on checkering is a suggestion which adds the complete finishing touch to the sharp V-points. There are

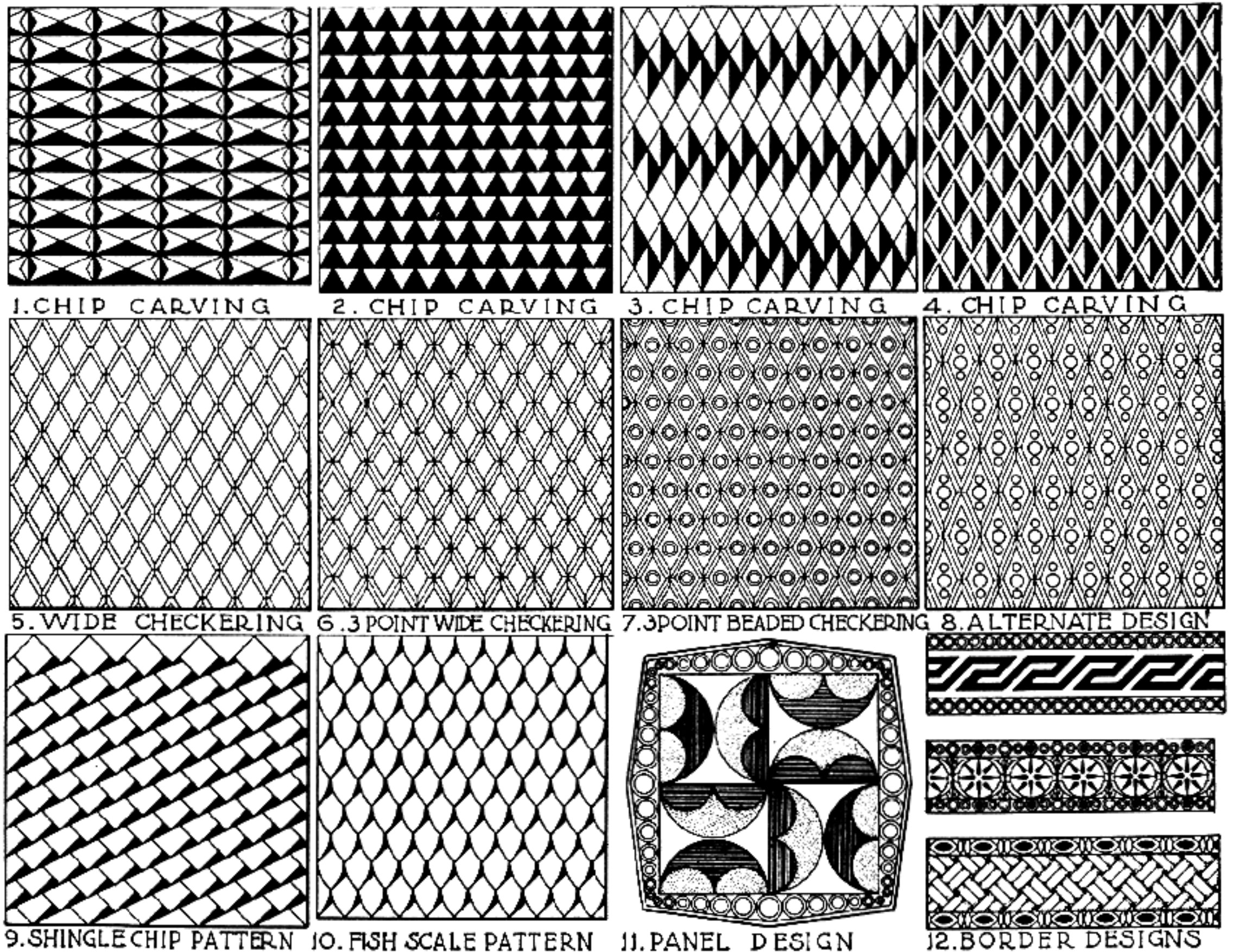

Fig. 92

Design suggestions for carving or checkering stocks

only two tools required for this work, the matting and round beading tools. Figure 92 will give the beginner various ideas for borders. The supply of designs may be worked out in various ways; they may be made very elaborate, far superior to carving on a gun stock, and more in keeping with a checkering design. Carving is a beautiful way of expressing artistic ability, but it is more or less overdone on some German arms. The beaded and matted borders are a form of design completely appropriate for checkering.

From among the designs we shall select No. 4 in Figure 89 for the forearm. The regular method of laying out the design is followed, except that we will allow for the wider border, which may be $\frac{1}{16}$ inch or larger, according to the beading tool used; but no larger than $\frac{1}{8}$ inch, for a beaded border which is any larger tends to throw the design out of all proportion. The smaller you can make the border, the neater the finish will appear.

The matted border along the V's on the front and rear of the checkering must not be any wider than $\frac{3}{8}$ inch and no narrower than $\frac{3}{16}$ inch. One-fourth inch is about right and shows up very well with the beaded border. This pattern, when added to the V on the pistol grip, should be followed out the same as on the forearm or it will throw the design out of balance. The matted border is given only in the front V, which you have followed on the forearm, but the beaded border is placed around the entire design.

The demonstration of such border designs on any stock will prove their object even among the most skeptical of critics, for it shows without a doubt that it completes something which is lacking on the checkering design. When a plain border is added, it lacks the finishing touches. It is far better to have only the one border line around the complete design, and at the extreme points use the $\frac{1}{16}$ or $\frac{3}{32}$ inch diameter beading tools to place one indentation, which is a circle. This looks as tho the points ended at a given distance instead of running out to a plain unfinished point. Figure 92 illustrates parts of borders. The student may practise on sample pieces to form some idea of what possibilities may be worked out to suit his fancies.

The borders should be laid out to the proper width with the dividers so that the lines will be an equal distance from the lay-out lines. With a flexible scale cutting the centers of the dividers' marks, draw a line parallel with the laid-out V, using a soft lead pencil; then either file or cut these in with the starting tool. The double parallel lines may be matted after all checkering is completed. Figures 93 and 139 illustrate these tools.

The matting tools for wood are a little different from those for steel. When filing their points, file rather deeply and not as closely together, bringing the points up very sharp; when completed, the tools look as tho a series of needles had been set in the top. Two tools are made on a square, rather large, and one is pointed on each end in order to

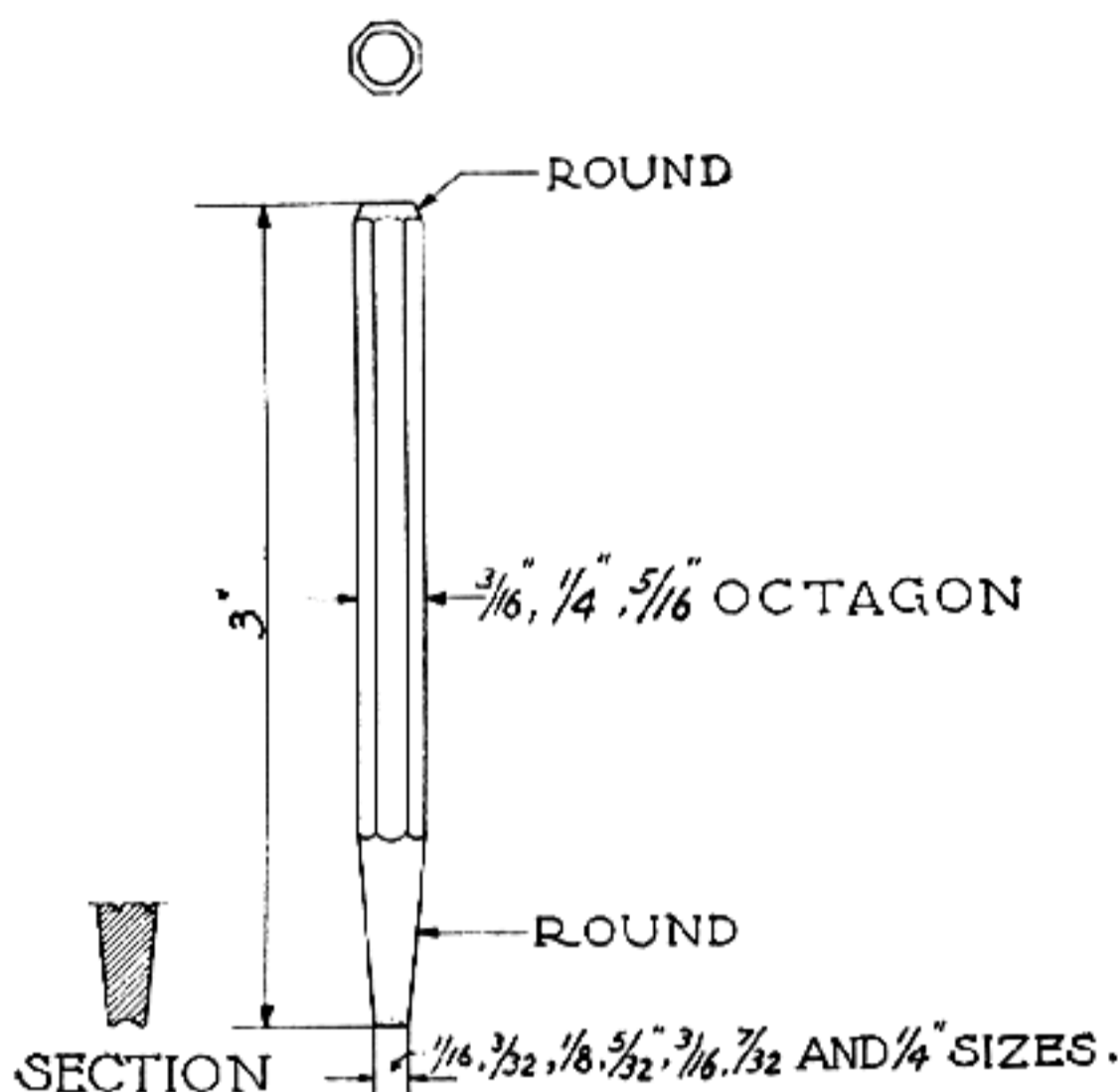

Fig. 93
Beading punch for border designs, etc.

make the extremely sharp V's or corners. While making the matting tools, you may also turn up the beading tools, which are turned from drill rod. The extreme end of the angle is the diameter of the tool and the cupped-out center must be very shallow but on a true radius. They are tapped slightly with the hammer, and the bead which is formed in the wood comes even with the surface; the outside edges slightly cut the wood, and make a clean, sharp, round mark.

Harden both the matting and beading tools and draw the temper to a dark blue. When using the matting tool, it is held in the left hand between the thumb and index finger, the little finger resting on the stock. Keep the tool off the surface about one-fourth inch. Tap the tool with short, fast, sudden blows. The spring effect given by the little finger keeps the tool away from the work, and the index finger and thumb are used not only to hold this tool, but to give it a slight turn, first in one direction and then in the other. Move over a considerable amount of surface at one time, and then go back over the same section until you have a well matted surface. Wood treated in this manner appears polished in spots, and the matted parts are very dark, a condition caused by the fine serrations of the needle-like points of the matting tool.



Fig. 94

Julia Thornely checkering the pistol grip of a finished stock. She is now a grandmother of 68 years, and has been in the employment of the Remington Arms Company for 53 years

Unless the beading tool is tapped very lightly, it will go too deep below the surface. When beads follow each other in rotation, they should connect and not overlap; therefore, when forming chains of beads, always work the tool away from you so that you can see the edge at all times and can be positive that the tool always passes the edge of the bead just made. With the beading tools in steps, you may use the largest one and so on down until you have a chain. Start again with the large one and continue to the smallest, or you may use the largest one three times and the next the same until the smallest is used, in a series of threes. There are such a number of border designs that I could continue with an endless chain of suggestions. They are very simple to work out, and the student can pass many hours decorating sample pieces of wood, either hard or soft, until he becomes accustomed to the methods.

Checked Butt Plates and Caps — Checkering on butt plates and pistol-grip caps forms an

added attraction and is a utility as well—on butt plates; pistol-grip caps are much better if left plain, tho the taste of checkering is often carried to such parts. Figure 95 illustrates checkering designs on butt plates and pistol-grip caps. The butt plates shown can be made either of buffalo horn or of steel. Some designs may be checkered in the wood itself; others can have a skeleton plate fitted and checkering placed on the exposed wood. This type of plate looks very well and may be used if recoil is not too severe. Checkering placed on the buffalo-horn plates can often be carried out in other designs than those shown here—also upon steel plates. These designs will give the reader suggestions for his own particular taste which he may change if he has a better understanding of scrolls and geometrical figures. The checkering shown on the pistol-grip caps may be used on specially-made buffalo-horn caps. It can also be placed on metal caps with a vertical attachment set upon the milling machine and the cap fastened on the rotary attachment or in the vise. By setting

the vertical lead at a 45-degree angle and using a small end mill, perfect checkering will be produced.

Matted Surface in Place of Checkering —

This method of placing a rough surface on the forearm and pistol grip is a very satisfactory way of eliminating a lot of extra work, and is, of course, more rapid than checkering. There is a considerable amount of surface to cover with the small matting tool, but as you will do this in sections it is surprising how short a time it takes.

Lay out for the border as previously described. If you are using a plain border or just the original lay-out lines, mat up to these lines, and if you wish a beaded border, make provision for it. The beaded borders make a very artistic finish for the matted surface. When you lay these designs out of paper, choose a pattern which will be in keeping with the matted surface. This class of work is better for the student to practise on at first than checkering, for it is very simple to apply to any stock.

If you should own a factory arm of any description, you can use this method in place of checkering, constructing a border in keeping with the general outlines of the stock. Nearly all factory arms are void of checkering; with a shellac finish it is possible to file out the borders and mat over the shellac surface very lightly, pounding it into the wood. When completed, apply a coat of raw linseed oil to darken the space that was worked on. The contrast between matting and shellac counteracts the plain appearance of the gun and produces a novel effect. Refer to Figure 103 for the effect of matting.

Carving — This branch of the gunmaker's trade is seldom used except in the rare cases when a customer wishes such work. The leaf, flower, animal, Gothic, or any nature-study design applied to a stock seems rather inappropriate. The plain chip design such as Figure 92 shows is more in keeping with a well designed stock but is rather difficult to execute. In the past, I have had two wood carvers work for me; I was greatly interested in their ingenuity and artistic ability, and particularly in their complete sets of carving chisels and other tools in their possession.

I shall presume that the student is anxious to learn this branch of decoration, and make practical use of it, not only on gun stocks, but on other wood work. The first consideration will be to procure a set of carvers' tools, which consist for the most part of chisels and gouges of different shapes and sizes. The number required may be from six to forty or fifty for the more intricate designs.

Chisels and gouges are to be had from $\frac{1}{16}$ to 1 inch wide with curves or "sweeps" in sizes graduated from a semicircle to a curve which is almost flat.

The beginner, however, need not possess more than from twelve to twenty-four and may make a start with even fewer. It is far better to learn to use a few tools before purchasing a full set. A tool of a known description is sought for and purchased with a knowledge of its advantage until the complete set is obtained. I would suggest that you study the J. B. Addis & Sons catalog for a very good selection. A description of all the different kinds would fill a large chapter.

Along with the tools you should procure a set of fine stones to keep the chisels and gouges to a razor edge. As Chapter I contains all this information, I shall assume that the student has already taken care of such a selection of stones. These tools are like all other wood-working tools when first purchased: they are ground but not honed or stropped.

If the beginner, through lack of opportunities for practise, does not wish to spoil a new stock, I would suggest that he find encouragement in the fact that he can never exhaust the interest afforded by this art in its infinite suggestion to the imagination and fancy. He may reasonably hope to gain enough experience with the tools to enable him to execute with his hands every idea which has a definite existence in his mind. Thus, in time the student may gradually work out for himself a natural and reliable method of expressing his thoughts. The scope of experience is very limited on stock work, but other fields are open to such work. There is in this direction a life's work for any student who aims at finding the bearings of his own gift; at the same time he can keep himself free to follow out the gun work which his thoughts dictate. As a suggestion, practise on Figure 96.

The first step is to lay out your design on transfer paper and pencil it into the wood. If you should be working on the forearm, measure the rounded surface with a tape, both front and rear, in the space you wish the design to occupy; then subtract for the border on each side. Lay out the design on the transfer paper and place it in position, first chalking the surface of the wood and then penciling the design in.

The first surprize which awaits the beginner and one which will open his eyes to a whole series of restraints in the freedom of his operations, lies in the discovery that wood has a decided grain fiber. You experienced this to some extent before, but now it comes in a very different manner, for you are only removing shallow cuts and your tools do

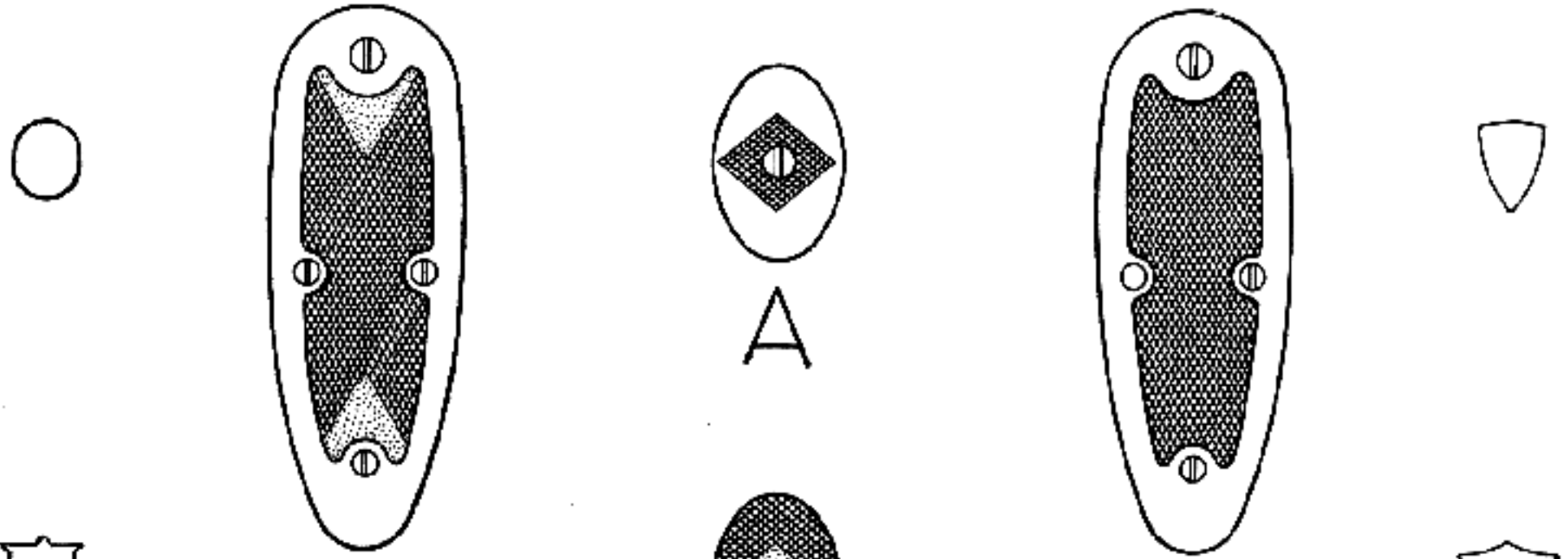

1



A

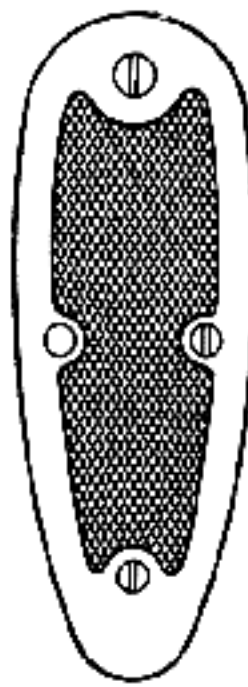

2

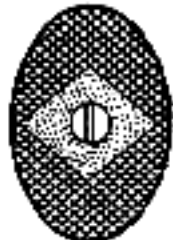

B

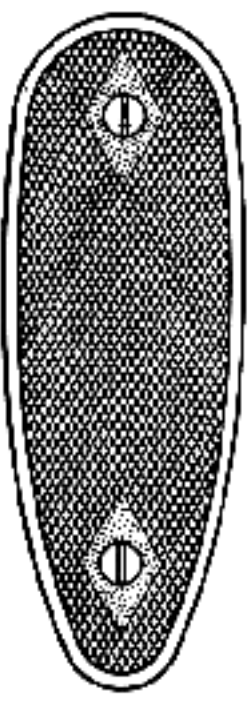

3



C

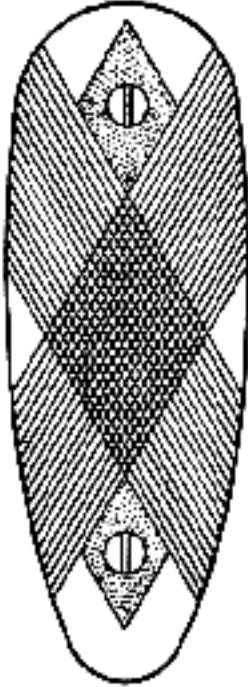

4

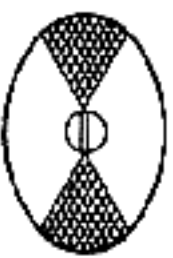

D



5

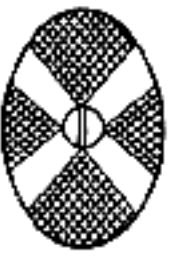

E

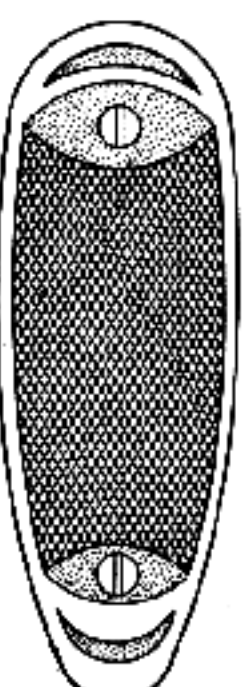

6



F

MONOGRAM SHIELDS

MONOGRAM SHIELDS

Fig. 95

Design suggestions for checkering butt plates and pistol-grip caps. Monogram or shield designs

not seem to be handled as you had pictured in the design. Even tho your tools are sharp, they will refuse to cut straight here, chipping off the wood, and by the time the piece is about finished and you are able to know the grain or fiber of the wood, a good many cut-outs are placed where they should never have been.

Suppose you have selected No. 1 in Figure 92 for your carving. It is very much like a checker-board design. This is a test of endurance, and as an experimental effect with carving tools, repeat the same-shaped diamonds until you have filled the entire space of the lay-out you have made for the forearm. All this work is done with thin flat chisels; by the time you have completed it, you will begin to understand and appreciate one of the fundamental qualities which go toward the making of a carver, namely, patience. You will have produced a thing which may give you pleasant surprises and elicit very natural admiration from your friends.

By the time you have completed the forearm you may have changed your mind about the pistol grip; however, you must carry out the same design, so your patience will be doubly tested. Patterns such as these can be drawn and laid out on your stock instead of using the transfer paper, but when using a leaf pattern or any other form of nature design, you will notice in carving pattern No. 1 that the corner of your chisel will do most of the work. At the same time, it will suit the different angles at the bottom of the holes. Each chip should come out with a clean cut; but to insure this, the downward cuts should be made first, forming the raised diagonal lines.

When you have successfully carved this pattern, Nos. 2, 3, and 4 may be done also. Introduce a very moderate amount of variety by using these on different stocks, and incorporate leafage or something of a nature that will be appropriate for a stock. When the student wishes to go further in the subject of carving, he should secure books on this subject, for I have only touched the surface as applied to a gun stock. Wood carving is a fascinating and interesting form of art, but a little out of place on a gun stock unless properly restrained.

Inlays, Shields, and Ovals—In the past two hundred years, various forms of ornamentation have been placed on stocks wherever the notion suggested; some on the sides of the butt stock, some on the sides of the pistol grip, and others back of the tang, along the sides and underneath the forearm. Today we have different conceptions of artistic requirements; we follow out lines of simplicity, and do not observe the old tradition of

misplaced artistic temperament. Not that we do not have this among us today—some of the so-called greatest creations of present-day art are a disgrace to modern civilization.

Inlays form a means of further adding individual expression to a stock, provided they are so placed that they will not conflict with the general outlines of the design. Shields and ovals have only one purpose—that of the owner's monogram or initials—and should only be placed either on the bottom of the stock, half-way between the pistol-grip cap and toe or about 1½ to 2 inches from the heel on the top of the stock.

The only metals which these should be made of are gold or silver. Gold should be between ten and fourteen carat, and pure silver about .04 inch in thickness. Figure 95 illustrates different shapes and forms of these to be made up and then formed to the contour of the stock at the place in which they are to be located. Two long tacks are soldered to the back about ⅛ inch from the top and bottom and are used to anchor the shields or ovals into place. Glue is used for this purpose when they are fitted into place. When fitting in a monogram plate, first straighten out the tack from the body and place it over the spot where you wish to insert it. Gently press the points into the wood and with a ⅛-inch drill bore two holes just the depth of these tacks.

Set the shield in place and with a sharp scriber mark a line around the outside and carve this out. Great care must be exercised so that there will be no openings between the wood and metal; it should be only deep enough so that it will stand up above the wood about .005, which allows enough to be filed and polished down to the surface of the stock. The very narrow carvers' chisels are used to set these in place, and lampblack is used to secure the bearing surfaces so that you will not take any more wood out than necessary. When it is down in place wipe off all the lampblack and with pliers turn a small hook up on the end of the tack and glue in place with heavy hot glue. Place a clamp over the shield or oval and let it stand for twenty-four hours.

Before clamping, carve out a piece of wood of the same contour as the shield and stock, for if you should only use a piece of flat wood for this purpose, you are liable to have a flat spot on the top of the shield which can never be removed. When it is polished and the stock is completely oiled, you may have your local jeweler engrave your monogram or initials in the metal very artistically.

Inlays are so placed that they will counteract the plain appearance of a gun stock according to

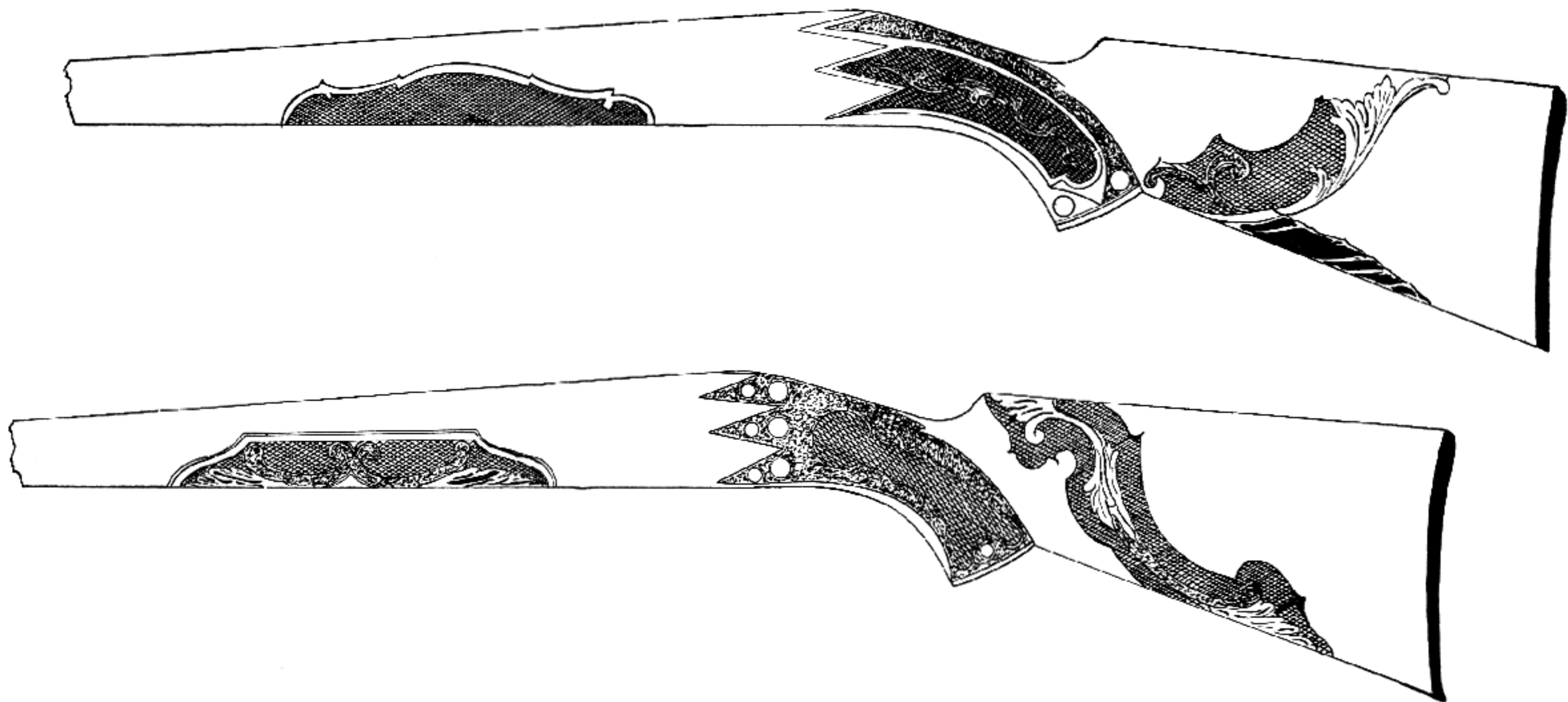

Fig. 96
Design suggestions for carving gun stocks



Fig. 97

Caliber .22 "Hornet" rifle made by Westley Richards of Birmingham, England. A fine example of the gunmaker's art

the taste or fancy of the owner. This type of ornamentation is by no means of modern origin; its development may be traced to a source in our early history of arms, in which we see very elaborate inlays of gold, silver, and ivory on arms of the nobility. This form of decoration is interesting and beautiful; however, we must carry out such art in a modern way, critically and with modern tools. It is a form of art which demands little save precision and patient application. There are only three materials available which may be used appropriately: ivory, buffalo horn, or ebony. The contrast of ivory offset with either buffalo horn or ebony is very attractive and softens the glare of the plain white ivory against the wood.

Another form of inlay is obtained with burls or knots taken from beautiful wood such as Circassian mahogany, Satinee, Italian and American walnut, yew, etc. They should be cut out to run true to the grain of the wood, and as nature never forms things in straight lines cut out your patterns as Figure 98 illustrates.

The main object of cutting these out in such forms is that when they are fitted into the surface of the wood you are less able to detect where they have been placed. They should be cut out so that the nature of growth in the tree is on an uneven line following lines of nature. An inlay in the form of a square, oblong, or diamond is very obvious, but this type deceives the eye, even tho you place a dozen of such inlays on one side of the stock. To inlay these knots or burls successfully, cut them out, allowing a slight taper to the piece. Lay one over the section in which you wish to insert it, and with a sharp scribe, mark the entire outline. Remove the center with a Forstner bit to a depth between $\frac{1}{4}$ and $\frac{3}{8}$ inch and remove the wood up to these lines, using the small carving chisels. Care and precision must be used to cut out every sharp corner.

Continue to try the inlay until it will just enter; then remove the wood on the sides so that the inlay is about $\frac{1}{8}$ inch from the bottom, which will allow enough for a driving fit to the bottom, and the

slight taper will completely fill and wedge the inlay to the sides when glued. After the inlay is fitted, glue and clamp in place, and let stand for twenty-four hours. Finish flush with the surface of the stock, and if well done it will be difficult, even for yourself, to see where it has been placed.

You have already discovered by practise that wood has a grain which sets bounds to the possibilities of technique. You have yet to learn that it has also an inordinate capacity for swallowing light. Now, as it is by the aid of light that we see the results of our labor, it follows that we should do everything in our power to take full advantage of that helpful agency. When setting in an inlay, place it in such a position that light will have the proper effect.

It is obvious that work on the proper inlays, applied to the proper place, when it cannot be seen is only so much labor thrown away. There is approximately a slight relative distance from which to view and determine the location of these inlays, aside from the fact that one may be used to fill a bad spot or may be so located as to add beauty to a piece of wood lacking in that respect. But what, you will say, has all this to do with copying the infinite variety of nature's details? Surely it cannot be wrong to imitate what is really beautiful in itself. You will find the best answer to this in the technical difficulties of your task. I have only laid out six of these odd forms, but you can lay out a hundred and yet never use the same one.

Figure 99 illustrates twelve modern designs of inlays, using ivory, ebony, or buffalo horn, which forms a contrasting color of black and white. We have in this discovery a clue to the meaning of the word "conventional"; it means that a particular method has been "agreed upon" as the best fitted for its purpose, for inlays in stock design. Not that experience had really anything to do with the invention of this method. Strange to say, my earliest efforts in placing these inlays were based upon a diamond, so temptation arose to see the effects of ivory on the outside and ebony or buffalo

horn for the inside. The results were very pleasing. Temptation arose in various directions, and I experimented further with various designs and effects. I have only given twelve, but the student may lay out an endless number to suit his fancies. The sizes of these may be varied to suit any condition.

No. 1 in Figure 99 is the plain ivory which is generally placed half way in a buffalo-horn fore-end tip and the wood. One may be placed on each side or just one on the bottom. The addition of the ivory in the buffalo horn produces a very pleasing effect. No. 11 is the diamond which is

placed in the forearm at the proper location for the sling-swivel eye to go through; ivory is again used. Nos. 2, 3, 5, 6, 7, 10, and 12 are used for the under side of the butt stock. No. 7, 8, 10, or 12 is always set half-way between the pistol-grip cap and the toe; No. 2, 3, 5, or 6 may be placed back of the pistol-grip cap, making a very pleasing effect, as these always have the ivory on the outside and either buffalo horn or ebony for the centers. Nos. 4 and 9 are often used in the centers of the checkering design on the forearm at the bottom.

No. 4 may be used on each side of the forearm if much checkering is used, but No. 9 is always

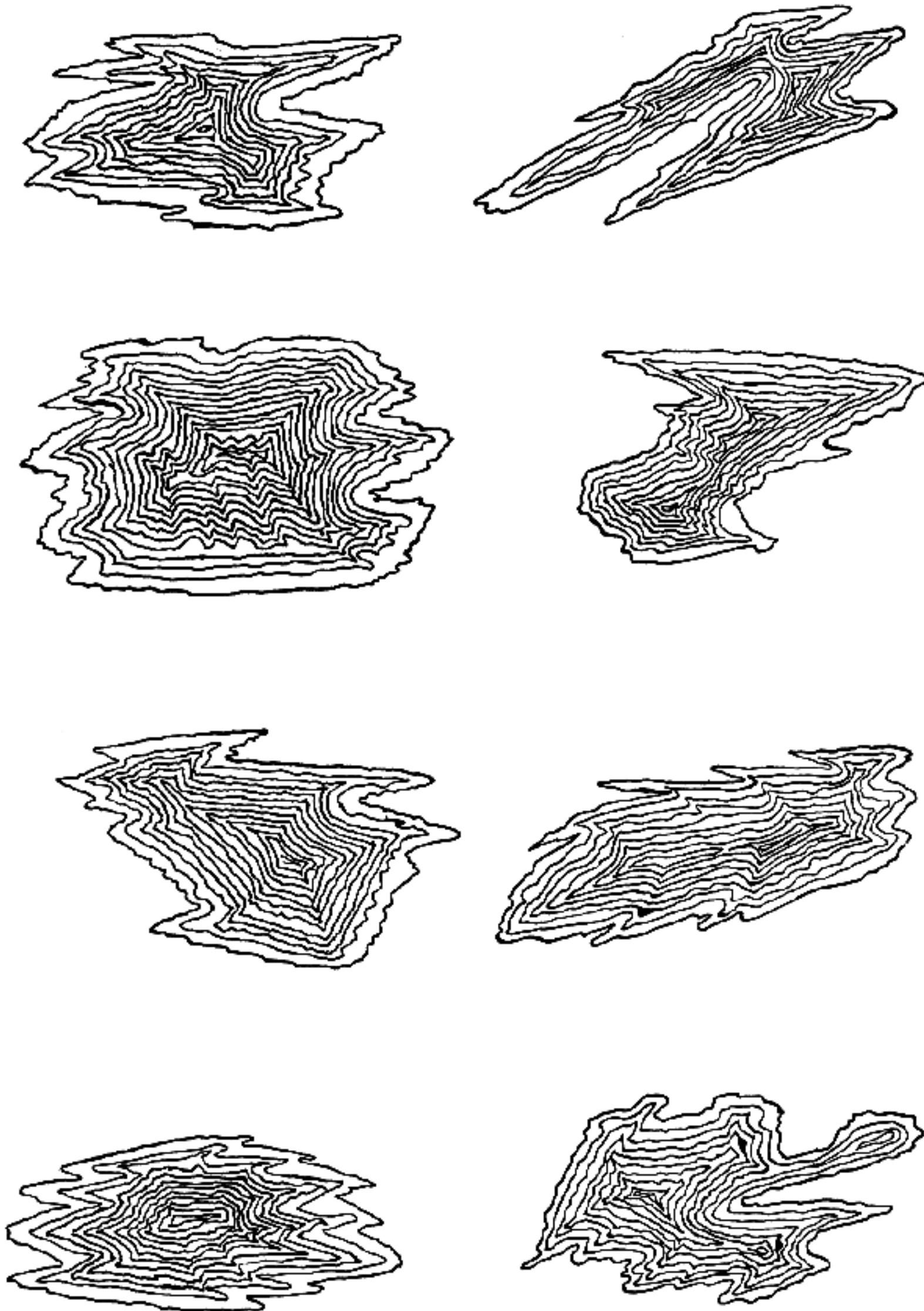

Fig. 98
Typical method of cutting out patches for insertions in wood where bad places occur

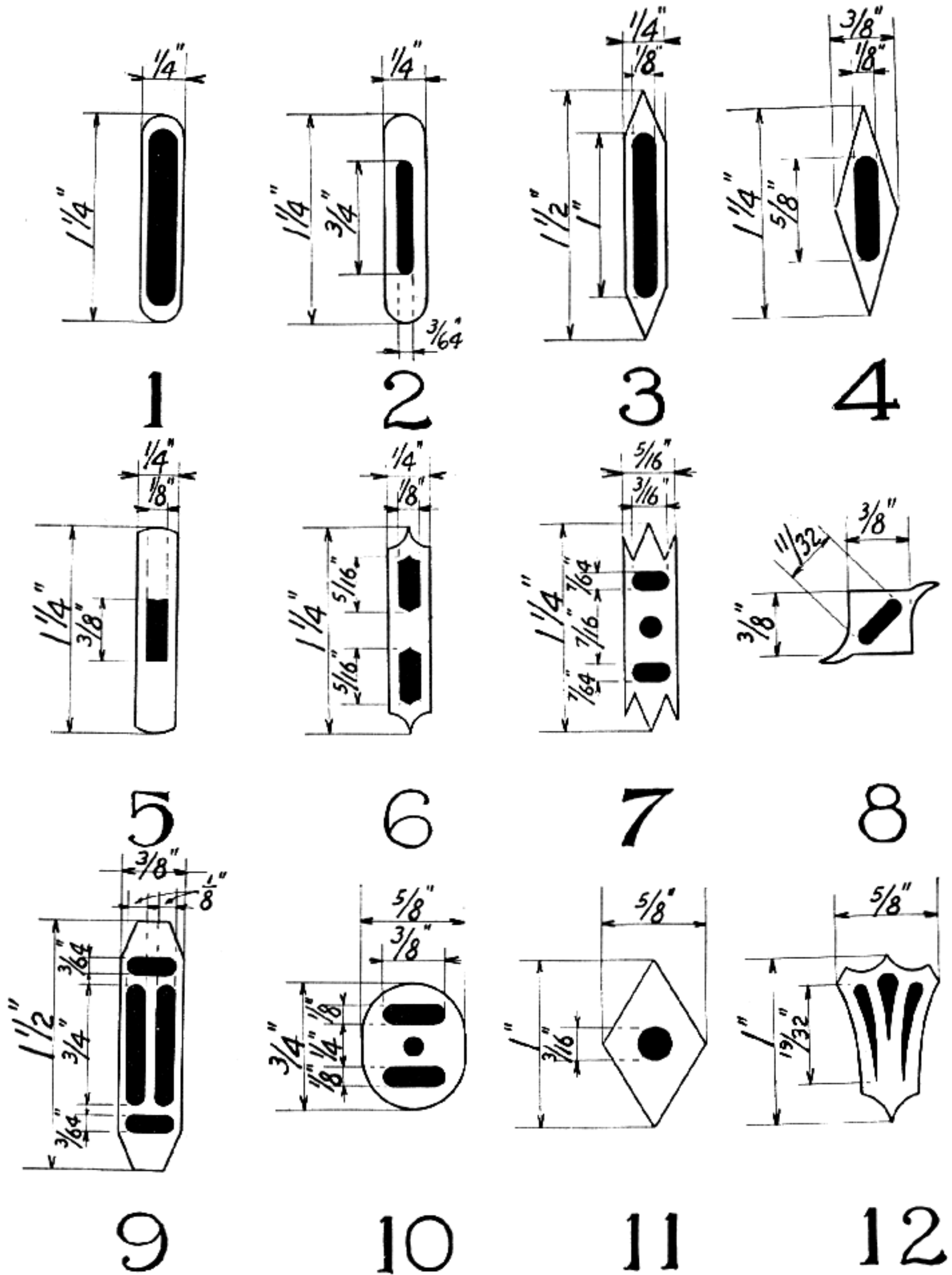

Fig. 99
Design suggestions for inlays in gun stocks

used in the center at the bottom. No. 8 may be placed about 1 1/2 inches back from the heel on the top of the stock, which offsets the plain appearance between the heel and comb. Round ivory plugs are often used in the buffalo-horn tip on the end and are placed in at an angle of 45 degrees. The end rounded at the bottom adds just enough difference to the horn to make it pleasing to the eye when placed in a gun cabinet.

When setting in the oblong inlays, the cut-outs are always made first in the stock either on a drill press or milling machine. Chapter IV describes some details of the set-ups for this work and also how to cut out the centers. The unusually formed inlays are always made first, laid on the stock, marked off with a scribe, and then set in. Use as much care as you did with the natural inlays, cutting out the wood in the neighborhood of a

delicate passage. Take time to cut the wood out mouse-like in small fragments. The depth of all these inlays should be about $\frac{1}{4}$ inch. Always make them with a slight taper so that when they are clamped in place the edges will have a perfect joint between the wood and inlay.

The center sections are made on a slight taper and placed in at a depth of $\frac{1}{16}$ inch from the bottom, so when milling these centers always leave a thin wall at the bottom to give the outside strength; then they will not split or crack when clamped in place. When these inlays are completely fitted, glue the center sections together with the outside in place, and clamp. Let stand for twenty-four hours, then finish flush with the surface of the stock.

Inlays should be placed in a stock after the first or second sanding takes place; after they are cut down to the surface, they are finished off just as you have done other finishing operations.

Throughout this chapter I have placed before the student ideas to work to from the checkering and borders to the inlays. As you know, the human imagination loves surprises and never wholly forgives the artist who fails to administer a pleasant shock. I have invited you to come forward and execute or duplicate this same work in order to see what a pleasant shock is in store for your own imagination. You will probably be

able to elaborate upon my ideas, for I have only laid the foundation. I do not encourage the copying of inlays or even some of the medieval designs to be seen on very old arms simply because they appeal to you. We must remember that these designs are symbolic of their time just as voluminous skirts and powdered wigs were.

After you have completed one or two stocks and thoroughly understand and appreciate the value of decoration, when designing any future details, arrange every subject with a view to reflecting your design as much as possible.

The chapter from the selection of woods to this must be understood very thoroughly, for as yet you have not begun to feel the extraordinary difficulty of making up your mind to just what you want in a gun stock. Meantime, I do not want you to run away with the impression that when you have mastered the principles of stocks and their design, all is learned. Until you have completed all that is necessary in order to turn out stock after stock with the ease of a laborer throwing shovel after shovel full of earth from a sand bank, you will find by experience, I think, that stock making has great possibilities and hard set rules. You may be counseled as to the best and most practical mode of expressing your ideas, but those thoughts and inventions must come from yourself if they are to be worth having.

CHAPTER XIV
Stock Surgery

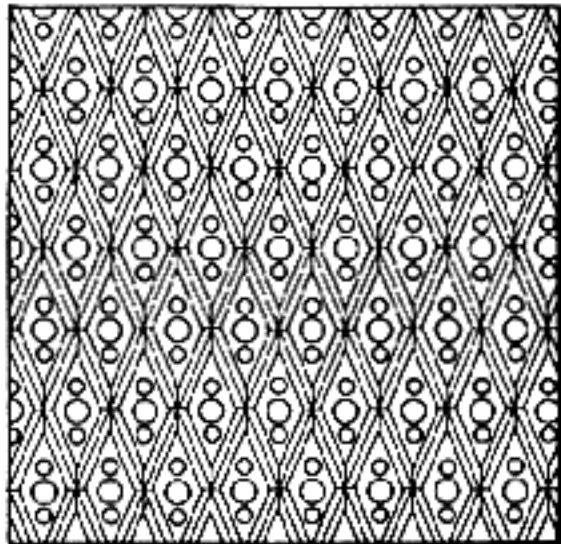

Stock Surgery

NO DOUBT the very ambitious amateur will wish to accomplish the more advanced work of a complete new stock, and this he can do from the fine outlines seen in photographs of some of the custom-made arms of British gunmakers or of our best workmen over here. One must hesitate at restocking a rifle or a shotgun until he has gained the necessary experience in the use of tools. He will then have the requisite confidence in himself. The remodeling of some of the old military arms such as the 45-70 model of 1873, the Krag models of 1894, 1896, or 1898, the present Springfield model 1903 or Enfield model 1917 in military and sporting stocks will furnish you with a means of acquiring that experience. Most factory stocks are good subjects to work over to your own ideas of stock design and fit. There are also many shotguns which do not come up to expectations; perhaps you own such a one. The raising of the comb, the lengthening or shortening of the stock, and alteration on the forearm will provide excellent practise with tools, and the improved handling and appearance will surprize you, not only by what you have accomplished but by the new ideas it has brought to your mind.

The Sporter — The Springfield "Sporter" model 1903 is an example of a stock which can be shaped up to much more graceful outlines. In fact the stock is purposely made unduly oversize so that it may be reduced proportionately. The Springfield .22 caliber has the same stock as the caliber .30 "Sporter," so you have two different rifles amenable to the same improvement. If you should, in experimentation, happen to spoil one of these stocks, you can obtain another from the D. C. M. for five dollars.

The first thing to do in this remodeling is to remove all metal parts: the barrel and action, butt plate, and rear sling swivel. To use a rubber recoil pad, buffalo-horn butt plate, or light steel butt plate, plug the present screw holes by fitting therein round wooden plugs and gluing them in place. I always fit a black walnut patch in the swivel cut-out and match the wood in color and grain as nearly as possible. I then use a standard

stock-swivel bow in its place; this looks far better than the military Springfield swivel. Fit the piece of walnut very closely and it will hardly be perceptible when completed. While the glue is hot, remove the small keeper pin in front of the front swivel, cut two small wooden plugs for this hole, and glue these in. These plugs will be cut, not with the grain of the wood, but crosswise, and inserted grain with grain.

The two stock reinforcing bolts can also be removed and both sides counterbored to a larger diameter and from $\frac{1}{8}$ to $\frac{5}{32}$ inch deeper. The same amount will have to be cut from the end of the screw, the ends re-threaded and placed back into position. Walnut plugs can then be glued in place over the bolt head and nut. This operation does away with the unsightly appearance of the metal on the sides of the stock. When all the gluing is completed, fit the new pistol-grip cap. The cap can be made of aluminum, bronze, buffalo horn, ivory, red or black fiber, or any other attractive material. Buffalo horn is the best of all. After the cap is fitted close to the front edge of the pistol grip and screwed up tightly, fit whatever butt plate you wish. The present butt plate on the rifle is far too heavy. Your main object will be to cut down all excessive weight whenever possible. I find that a buffalo-horn butt plate is much better in appearance, and being light it will enable you, by varying the thickness, to make the stock to the proper length.

When fitting the butt plate, the pitch or angle of butt to the horizontal of the gun must be taken into consideration. If you are a heavy-set person with a full chest, you will require considerable pitch. We had best designate this by the amount the front sight recedes from a vertical plane when the gun stands on its butt. This, in your case, would be from 4 to 7 inches. For a thin person the pitch as received, of 3 to $3\frac{1}{2}$ inches, is correct. When fitting the butt plate you can also get a little cast-off or swing to right in the stock— $\frac{1}{8}$ inch will be enough.

A recoil pad will be a great help to those who are at all sensitive to recoil and to anyone who uses a rifle in a hot climate, where one frequently

shoots without a coat. There are two objections to rubber recoil pads; they add weight, and they sometimes prevent quick aiming by clinging to the coat. If you cover the face with finely finished leather, and cement this securely in place, it will eliminate the friction of the rubber. A recoil pad is the neatest means of increasing stock length, providing you are not above the average in height and length of arm. It is very seldom necessary to lengthen the sporting stock by gluing a piece to the end together with a recoil pad. When the recoil pad is placed on a sporting Springfield stock it lengthens it to about $14\frac{1}{2}$ inches. This length, when you take into consideration your hunting coat, is too long for comfortable shooting. A little too short rather than a little too long is a good rule to follow.

The drop from line of sight on the "Sporter" stock is just about right for the average person, and it is never necessary to build up the comb or heel. However, you can give the stock more drop by extending the toe and gluing a piece of walnut from the pistol grip to the butt plate. This makes it possible to drop the butt and still hold the length of butt plate to $5\frac{1}{8}$ inches.

After this important work is completed you may proceed to shape the stock to new outlines. If a rubber recoil pad has been used, sand it down until you have removed at least $\frac{1}{16}$ inch from each side of the butt stock. The same should be done with a buffalo-horn butt plate and with the shotgun type of butt plate. You have too much wood and it must be reduced to the size of the butt plate.

The spoke-shave will now come into play to remove the surplus wood on the stock along the sides of the action and around pistol grip and forearm. As to the end of the forearm you may either round this up to the barrel as the British

gunmakers do or work a "schnabel" on the end similar to some of the factory stocks. Make the undercuts at the comb, similar to some of the better shotgun stocks, if you so desire. This will also give better lines to the hand-hold and a better place for one's right thumb.

After the stock is completed the next step is to get proper balance. This consists of boring out the butt stock in order to reduce or add weight. Boring out the butt stock must be done with care, using a wood bit small enough not to come to the surface as the stock area gets smaller. A series of three or four holes may be bored and you will be surprised to see what an amount of wood can be removed reducing the weight and bringing the rifle into better balance.

The stock will now be ready for smoothing and polishing. I refer you to Chapter XII for a complete description of these processes. Well placed and executed checkering will complete the work.

Krag and Springfield Service Stocks — An example of attaching combs and pistol grips on a Krag stock is shown in Figure 100. Since we have mentioned the Krag or Model 1898 Springfield rifle we will describe in detail the course of work required to put a service stock in the same class as a sporting stock, completed with pistol grip and raised comb. The Springfield model 1903 service and the Krag are alike in the butt stock, so whatever work is intended on the Springfield may be duplicated on the Krag. There are many Krag rifles in the hands of the American public, as these rifles are now obsolete in government service. It is necessary to do considerable work on this type of rifle to make it into a sporting arm, but when it is completed you have one of the best bolt-action

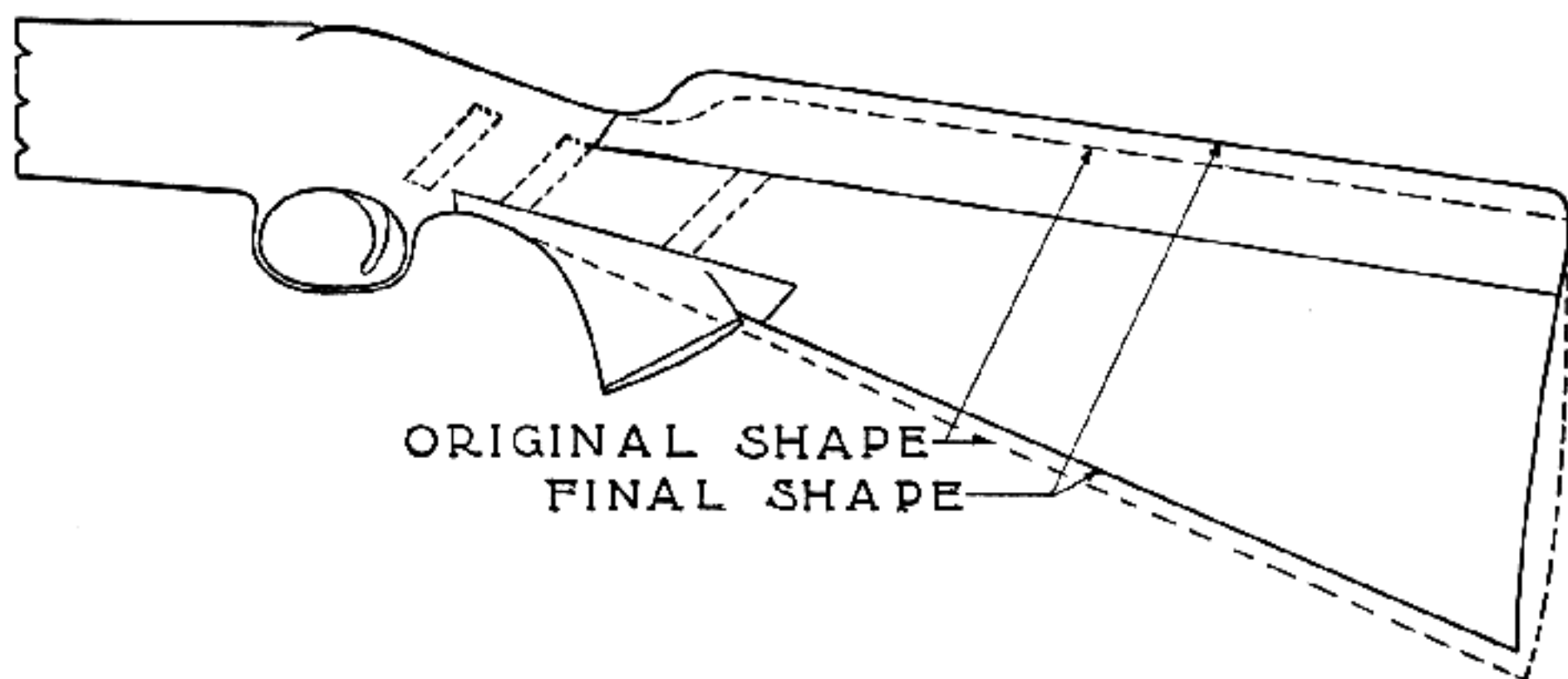

Fig. 100
Layout for inlay insertions in military service stocks

rifles that can be owned. It has only been a short time since I changed my opinion of these rifles, for when I was at the Arsenal, the Springfield model 1903 was my favorite. At that time the Springfield had become the standard arm and the Krag only a standby. After the government supply of Krags became exhausted in 1931 and these rifles were out of reach, I began to see them as of some value, not because of the smooth working of the bolt, but because of the handiness of the magazine. In the future, the Krag rifle will be more highly appreciated and will always remain one of the most popular big-game rifles.

The Attaching of Combs and Grips — Figure 100 illustrates the proper cut-out for the insertion of a comb and for a pistol grip upon a service stock, together with the correct method of lengthening one of these stocks when necessary. The drawing will show what may be done in the way of reshaping these butt stocks to obtain any desired shape and dimension. The dotted lines show the original shape of the stock, while the heavy lines show its shape after remodeling. The thin full-length lines show where the saw cuts will be made and the pieces of walnut inserted. Match these in color and grain to the wood in the original stock. The first cut is made in the upper side of the grip between $\frac{3}{4}$ and 1 inch ahead of the comb of the original stock. This cut is marked deep enough so that when the piece is finished to the proper outlines, the comb will not come out too thin.

With a small tenon-saw or hack-saw, start $\frac{1}{16}$ of an inch inside the line you have scribed from the butt end to the first cut made ahead of the comb. Having removed this section, plane your insert perfectly straight on the bottom surface and cut the ends to the correct angle so that it will dovetail into its position ahead of the comb. When you cut this insert allow enough in height and width to give you excess wood for finishing to the dimensions you require. Work down the surface with a sharp chisel to a perfect plane in all directions. Work it slowly down to a fit, testing it constantly until it is impossible to see any light in the joint. Now rub blue chalk on the surface of the piece to be fitted, and spot the two surfaces together by rubbing back and forth slightly. With a file remove the high spots left by the chalk. Continue this until both surfaces are in perfect contact with each other. Make sure that the two angles fit perfectly. From the piece you are fitting remove all traces of the chalk with a damp cloth and you are ready to glue it securely in place. The question has often been asked me if these pieces should be doweled. No, I do not find

it necessary to use dowels on perfectly glued joints. Use the best grade of hide glue, freshly made and applied hot.

It is necessary to work very fast when gluing wood together. Coat both surfaces with the hot glue, and instantly clamp. Hold firmly together with a couple of cabinet-maker "C" clamps. Tighten the clamps so that all surplus glue is squeezed out between the joints. Always have your clamps opened to the exact size before applying the glue, as instant contact is necessary. At the ends of the insert, where end wood meets end wood, it is a good practise to size with very thin glue (sizing is your glue thinned down with hot water), letting this soak in before applying the glue. This prevents entire absorption.

For the pistol grip, saw the cut-out at an angle of about 20 degrees from the straight surface of the stock. This cut should be deep enough so that it is possible to make a full close grip. The common mistake is to cut this out too shallow, making it a narrow grip when completed. The original stocks on the service and Krag rifles are made of a walnut which is not very strong, and it is, moreover, materially weakened by these inserts; hence I have found that the best practise is to put in three dowels as shown in the drawing. This will eliminate any possible chance of the stock breaking. I have found that it makes no difference how well the inserts fit; unless there are dowels there is a possibility of these stocks splitting from the recoil.

Your insertion will be a block of walnut, cut so that the grain runs well in line with the grain in the stock. Plane off the side you are fitting to the bottom of the stock to a perfect surface. The front angle of 20 degrees is to be laid from this surface and the back angle should be 10 degrees off from the side and 20 degrees on an angle from the flat surface. The 10 degrees makes it possible to fit in the block, giving it a wedge effect; at the same time you are able to secure perfect joints at the bottom and on the ends.

Having made the insert, lay this piece over the part where the cut is to be made and mark with a knife blade, allowing $\frac{1}{8}$ inch or more on the front and rear ends, for fitting the angles correctly. Trim out the wood with a wide flat chisel to the proper depth on a scribed straight line. Use a scale or make a straight edge from a piece of hard wood. Begin to fit in the block, cutting down the angles until the block goes in at least three-fourths of the way. Coat the surface of the block and the dovetails with blue chalk. Start the block back again to find the high spots, and remove these with a sharp flat chisel. Continue until the block has a perfect bearing, both on the flat surface and angles. Use

the pressure of your hands only to fit the block, for if you use any other means you will split the wood near the trigger guard. Make the blocks at least one inch over the width required, so that you will have $\frac{1}{2}$ inch over on each side of the stock when fitted. You will now bore two $\frac{3}{8}$ -inch holes for dowels as shown on the drawing and glue them in position. Place the dowels so that they will reinforce the stock at the points where it is liable to split. Let stand for four or six hours and trim off the dowels flush with the surface of the cut-out. You are now ready to glue in the insert. After clamping let stand between 24 and 36 hours.

The third reinforcing dowel is bored in at an angle starting from the inside of the trigger guard, using a $\frac{3}{8}$ -inch bit and boring well up in the stock. Glue and let stand between four and eight hours. Trim to the original lines of the guard. The drawing shows this location so placed on the angle as to take any shock that the two straight dowels will not stand.

The next stage is to determine the correct length of the stock. The service stock measures only $12\frac{7}{8}$ inches from front of trigger to end of butt plate. This will be found too short, so if you wish to fit a metal or buffalo-horn butt plate you will find it necessary to glue a piece of walnut on the end to lengthen it. Select a section of walnut to match the grain in the stock. The stock must be cut off at least $\frac{1}{4}$ inch to get to a place where the oil has not penetrated, as glue will not adhere where oil is present. Get perfect contact between the stock and the piece to be fitted, using the piece as a master to spot to the face of the stock. Glue and clamp in place, remembering the preliminary "sizing." Let stand for 24 hours. Either dowels or substantial wood screws will be necessary for good security.

If a recoil pad is used this will lengthen the stock to the required length for the average person, which is $13\frac{3}{4}$ inches. When one of these pads will not lengthen the stock sufficiently, liners of black rubber can be built up under the recoil pad; these are not at all unsightly.

In working the stock to shape, the first step will be to mark off the drop from line of sight at comb and heel. Then on the top of the stock draw a center line from comb to heel. Check the stock for the required pitch while the rifle is assembled. After the end is cut off and a flat surface filed for the butt plate, scribe a line from the center established at the heel down to the toe. Now if you should desire a little cast-off, carry this line to the right $\frac{1}{8}$ inch. That would be about all the cast-off you could get on such a stock. Attach the butt plate, allowing a drop at the heel of between 3 and $3\frac{1}{4}$ inches.

At the comb I always leave room for the bolt to just clear; this gives a drop of $1\frac{7}{8}$ inches when using aperture sights. You will notice on all my stocks that I give a Monte Carlo effect with a drop of $2\frac{3}{8}$ to $2\frac{5}{8}$ inches, starting with $2\frac{3}{8}$ inches drop at a place about two inches from the butt plate. Of course we have made the required drop at the heel, so we shape the top to these measurements, for the reason that in trying out the gun we can always reduce the Monte Carlo until the stock fits perfectly. Some do not require this additional height, but nearly everyone requires a drop between $2\frac{1}{2}$ and $3\frac{1}{4}$ inches when the gun is brought up to firing position.

If you are tall, long-armed, and have a long neck, you will require a straighter stock. The Monte Carlo effect is an advantage together with having the butt plate come well down on your shoulder. Such a build requires a cheek rest as well as a straight stock, and not a great amount of pitch. A long stock is very advantageous in deliberate shooting, but for moving game and when one is dressed in winter clothes, a shorter stock will be better. A cast-off of $\frac{3}{16}$ to $\frac{5}{16}$ inch brings the gun more naturally to the eye.

A stocky person with a short neck, short arms, and a full chest will require less drop at the heel, and for this purpose you can also reduce the drop of the Monte Carlo. With the Monte Carlo such a person does not require a cheek rest, but a full comb and stock.

It is better that the stock be full where it comes against the cheek as it gives more support to the gun. You will notice that I have given a measurement of between $3\frac{3}{4}$ and 4 inches on different drawings from the top of the comb to the front edge of the pistol grip, and a length between $2\frac{3}{4}$ and 3 inches back of the pistol grip from the comb, and also a measurement between 3 and 4 inches back to the pistol grip from the trigger to the edge of the pistol grip. Carry a measurement between 3 and 4 inches back to the pistol grip from the trigger to the edge of the pistol grip. Now carry a measurement of $1\frac{7}{8}$ inches from the edge of the pistol grip back to the $2\frac{3}{4}$ to 3-inch line. This gives you the angle of the pistol grip. Saw out to the lines thus made and place the pistol-grip cap in position at the edge of the front line, which is the distance from the center trigger to the edge of pistol grip. You may now start to rough down the wood to the pistol-grip cap, working to the edge to get the final shape of the pistol grip.

A great mistake the amateur makes in his first attempt is to undercut too great an amount of wood on the grip in front of the comb; the second mistake is to continue the shaping of the form of the

grip cap up to the comb. The beginner should study the photographs of various designs of stocks in the subsequent chapters and notice that the line of the pistol grip only continues a short distance upward along the pistol grip. This is to maintain a well-proportioned outline to the under side of the butt stock. The undercuts at the comb are also made for better outlines, and a cut-out on the right side for a thumb rest.

After having roughed down the insertions, mount the stock to your shoulder with the action and barrel screwed in place, in order to see just how the stock fits. Generally the comb will be found too high clear back to the raise of the Monte Carlo effect. Continue to reduce this without cutting the point of the comb away, for you have the proper height at that point. Continue to reduce the wood until you find when you bring the stock up to your cheek that the sight comes in perfect alinement on the object you are aiming at.

The fore-end of the stock has not yet been mentioned, so we shall do a considerable amount of

filed or cut out with a dovetail at each end. A piece of walnut is now fitted into the slot thus made and glued into place. After allowing the glue to stand for the required length of time it is finished flush with the outside. The inside must also be formed to the proper contour. After sanding and oiling, the guard is given straight lines over the sighting plane, a standard checkering tool being used for this purpose. These hand-guards could be moulded from hard rubber, but since there is such a very limited demand it does not pay to have a mould made. Personally I do not care for the hand-guard left on, for one can secure better outlines by leaving it off. Then you can round up the edges of the forearm from the receiver to the end of the stock and so do away with the flat surface of the forearm along the barrel.

After doing all this you are ready to set the stock, sand it down to a smooth finish, and complete the finishing.

Figure 101 gives a completed Krag rifle, showing the insertion of the top piece and pistol grip, also

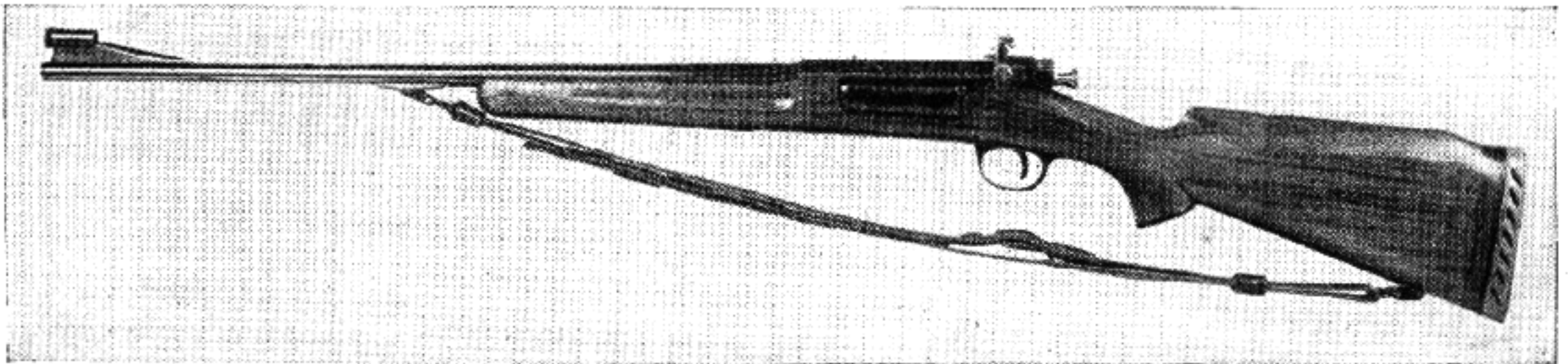

Fig. 101
Model 1896 Krag rifle worked over by Dr. M. D. Stepp: the graceful outlines are suitable for a one-piece stock

work on this after deciding what is needed, such as proper length, filling in the barrel channel, and the finger channels if they are to have pieces inlaid. You may either round the end in the English style or with a "schnabel." Of course it is necessary to cut the stock off about $2\frac{1}{2}$ inches ahead of the present front swivel and then to glue in a piece of walnut in the relief cut so that there will be no opening at the end. On the Krag stock it is not necessary to have any insertion for the barrel, as these stocks fit very well to the wood. The only thing you need to do is to fill in the small cut-outs made for the top hand-guard springs. If you want to leave the top hand-guard on and only fill in the cut-out where the sight comes through, all well and good; this is altogether up to the person who is going to use the rifle. These are so thin that a form is first made of wood and two C-clamps are used to hold each end down. The opening is then

the stock lengthened and the forearm end rounded as made by an amateur from these directions which he carefully followed. There were some very small openings between the joints which are not pronounced in the photograph, but they scarcely showed after the stock was oiled and checkered. Such perfect fits can be made on flat surfaces so that when completed you can hardly notice a line. Notice how well the forearm is shaped; an outline not to be improved upon by a professional. Great credit must be given a person who is able to achieve such fine results the first time.

He who first attempts such an operation as this on a Krag or Springfield service stock has one important thing to remember—to follow all details and instructions given. Go slowly and watch every move you make so that mistakes will not creep in. Of course if an opening in the joints should show up when you shape the stock you can always resort

to a "dutchman," taking a piece of walnut, sharpening it into a wedge, and gluing it in place; but this is only an expedient and will remain to tell you of your blunder. Experience is our best teacher. If it is possible for the beginner to accomplish such a perfect specimen of inlay work as shown in Figure 101, what can one who is more familiar with the use of wood-working tools perform? All this fine work was done with the very limited equipment of a hack-saw, a bastard file, a wide butt chisel, a jack-knife, and sandpaper.

out a piece to match the wood in the stock so that the grain will match and run in the same direction. Channel out the insert so that it will overlap at least $\frac{1}{2}$ inch on the right-hand side of the comb. Work down the block until you have a fair fit; then coat the surface of the stock with blue chalk and gently rub the cheek piece in the exact position it is to have. If it is impossible to obtain any movement of the piece, gently tap it so that the chalk marks will show on the block. Continue to work down these high spots until a true bearing is

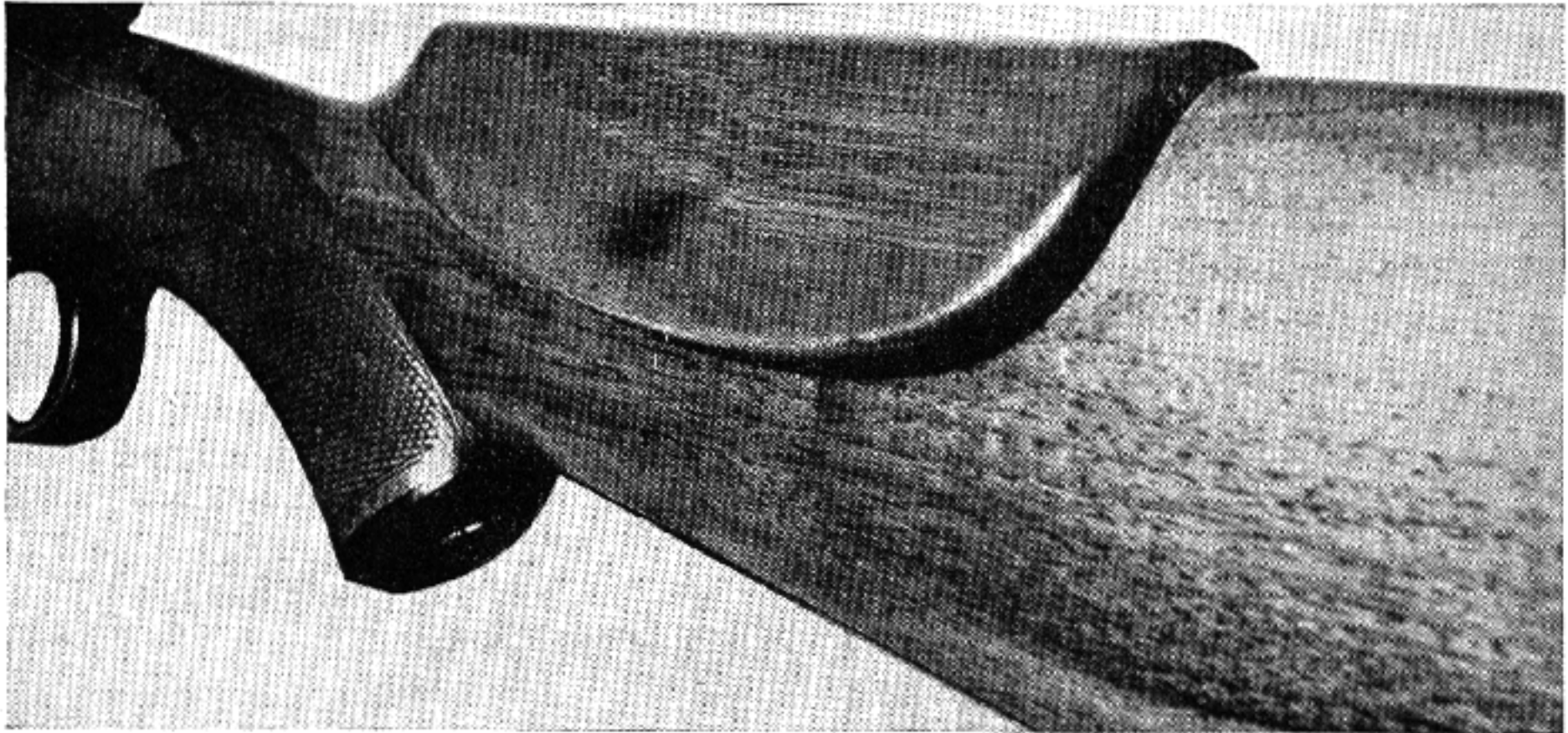

Fig. 102

The applied cheek piece. When set in place successfully it appears as the integral with the stock

Cheek Pieces — Figure 102 shows a very successful method of attaching a cheek piece. This method is particularly useful when the comb is rather low and a person does not wish to go to the expense of having a new stock made. Such an addition glued in place on an old stock answers the purpose very satisfactorily and should not show any lines. You will remember that it is necessary to get under the oil or varnish finish in order to have the glue effective. Cut into the stock so that you obtain a true surface on the top and sides. Then cut

secured. Take a damp rag and clean off the chalk. While the wood is wet, glue it into position and clamp. Let this stand 24 hours before shaping to the desired outlines.

A cheek piece can be placed on any stock, either rifle or shotgun, by first cutting out the cheek piece to the proper form from a piece of walnut, having the grain run lengthwise with the wood in the stock, or by using a beautiful contrasting burl and inlaying this. Having secured the proper lines, place the piece in position on the stock and scribe around it

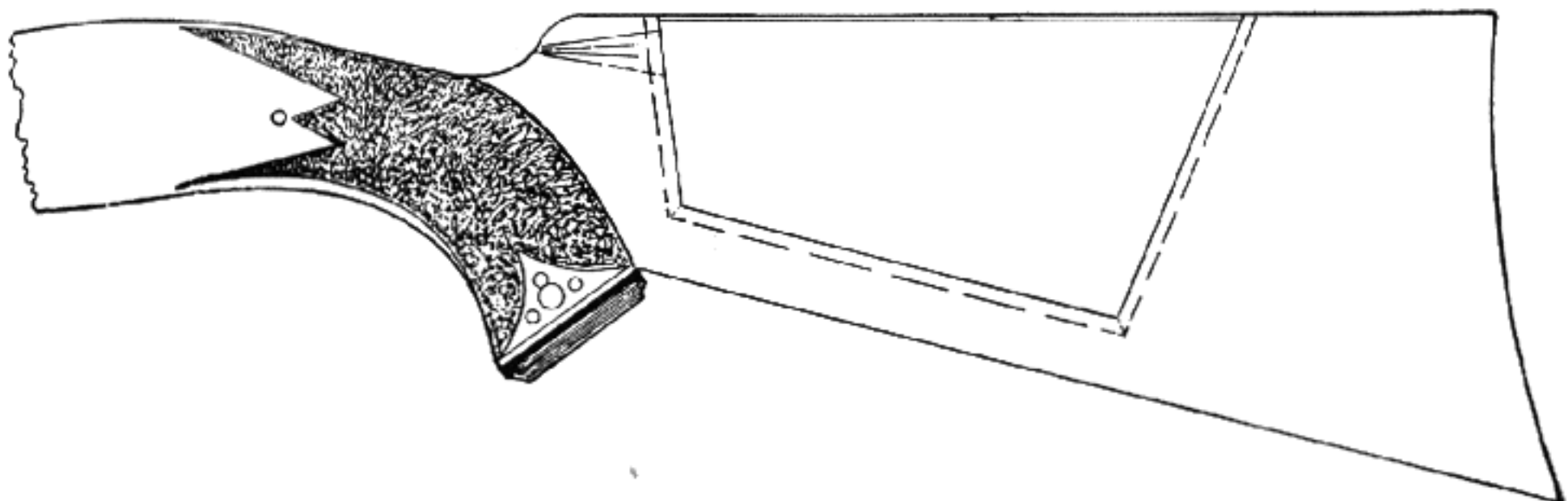

Fig. 103

Insertion of cheek piece

very carefully with a sharp scribe, then cut out the seat in the stock for the cheek piece to lie in. Remove just a little more wood at the top edge than at the lower edge of the seat. Spot the cheek piece on the flat surface with chalk, as before described, and glue into position. Clamp well and let stand 24 hours. Then shape the surface until it conforms to your face. I always hollow out my cheek pieces where the cheek rests; this is far more comfortable than a straight flat surface. When such a cheek piece is made you can not see any joint except along the top edge of the comb.

Figure 103 will show the method of fitting this cheek piece. I have also dovetailed cheek pieces into position when raising the comb, but this is a rather difficult operation to perform, and the other method is the best general practise.

The student may do considerable trap shooting and desire a Monte Carlo comb on his shotgun. This can be done in the same manner as shown in the photograph in Figure 104, but the effect should

breaks the monotony of them and adds a touch of style.

Refinishing — Any stock having an oil or varnish finish must be completely refinished. A varnished stock, if it is to be changed to an oil finish, must have all the varnish removed, and must be finely sanded and built up with repeated applications of oil. An oil-finished stock is very desirable, as its surface can be constantly renewed and scratches obliterated. Chapter XII gives full instruction for the finishing of stocks; this applies to old stocks as well as new.

When you alter or cut down a varnished stock, you will be forced to refinish it completely. Rubbing over the fresh spot with shellac or varnish makes a very poor job. Always prepare the stock for a new finish and you will be far better satisfied with the results.

Ideas on Patches and Insertions — Usually

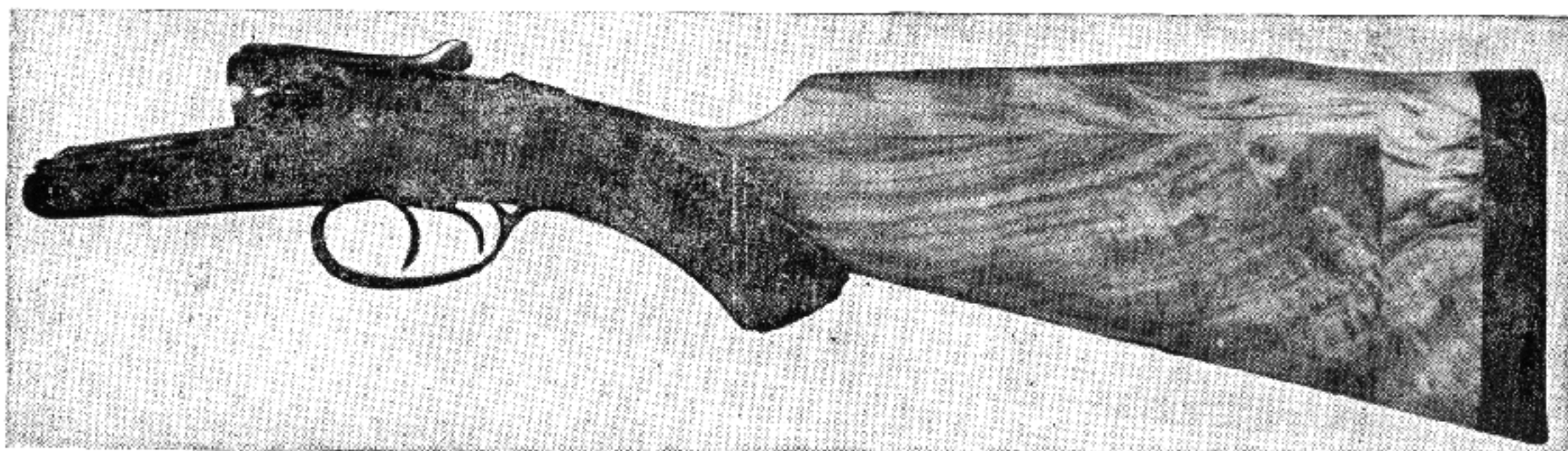

Fig. 104

Parker 12-gauge shotgun. The stock has been lengthened and the comb raised. Note the perfectly glued joints and how well the wood is matched

be carried well back and the overhanging part allowed to extend down $\frac{1}{2}$ inch or more on the right-hand side. Spot it in the same manner as given for the rifle, glue into position, clamp, and let stand 24 hours. Then shape to the outlines required; on completion the joint should not be noticeable. This method of attaching Monte Carlo combs proves very successful on factory-made arms such as the Winchester models 97 and 12, Remington model 10, and Browning automatic. You do not weaken the stocks by this method as you would if you should make an insertion, for most of these guns have a bolt running lengthwise through the stocks to hold them to the action.

The shaping of cheek pieces such as these described must be done in an artistic manner or their appearance will be unattractive. A rounded bead raised about $\frac{1}{8}$ inch from the butt-stock outlines

when a person gets the notion to lengthen a stock, his first idea will be to build it up with layers of leather, hard rubber, red or black fiber, ebony, different-colored woods, etc. These may be glued on in layers, and when completed they look quite well. But this is the rankest kind of patching and should be avoided if possible. When it is possible to secure a well-matched piece of wood to lengthen a stock, by all means use it, for if it is well jointed it is hardly noticeable. Black rubber or buffalo horn are the only butt-plate materials which give a stock the real touch of good taste.

You will sometimes hear of hollowing out a piece of wood for a pistol grip and gluing this in position on the under side of the stock. This is a very poor method. First, it is an impossibility to retain the inescapable feather edges of the sides without their showing, and secondly it makes a very weak joint.

Such ideas are contrary to the laws of woodworking and should never be attempted.

You will find a number of stocks with pieces broken off the toe because the grain of the wood is short at that point. This can be remedied by cutting the stock back about two inches from the end of the butt plate and fitting in a metal patch a little wider than the stock. Drill and countersink for two wood screws and file to the outlines of the stock. Case-harden this together with the screws and you have a neater job than with a piece of wood glued in place.

When plugging holes rendered necessary in the repairs to broken stocks where screws are used to tighten the break, it is necessary to select wood to match the wood in the original stock, and to turn it with the side grain exposed. These plugs are easily made by marking them out with a pair of compasses at a spot in your board which resembles the wood surrounding the hole to be filled. Cut this out in a square with your saw, then to an octagon with a sharp chisel from the square; a little filing will bring it to a fit. Make your plug slightly tapering so that it wedges tighter as you drive it in. Wood is elastic in a measure and the microscopic accuracy demanded of metal is not required. These plugs can be made on your lathe, but they will take longer and be no better.

When swivels or screws are removed from butt stocks and the holes exposed to be plugged or inlaid, it is best to drill out the hole and then counterbore to a depth which will hold the inlay and at the same time be large enough in diameter so that it will look well when finished. Materials for such operations are either buffalo horn or ivory. If you want to accomplish more by means of an artistic inlay you can cut out a piece of buffalo horn or ivory in a diamond shape or any other balanced form that will look well, and set these by gluing them in position. You may obtain a very attractive color contrast by using ivory outside with the wood and buffalo horn in the center. Chapter XIII describes such methods.

Sometimes a shotgun owner, having a gun with some form of pistol grip, wishes a "straight grip" instead. This has always seemed to me a logical desire.

In British practise the "straight hand" is standard in field shotguns; half pistol grips being confined to heavy duck guns, and full pistol grips to rifles. With two triggers a pistol grip is really an anomaly, for if it is right for one trigger it must be wrong for the other. A straight grip, however, affords an easy shift for each trigger and furthermore gives a racy outline to a light gun which adds much to its beauty. This wished-for change is not

always an easy one, so one must study the possibilities carefully before attempting it.

After you have made a thorough survey of the stock and found it possible to eliminate the grip, you will find it quite easy to make the actual alterations. Saw off the grip and use either a spoke-shave or cabinet rasp to remove the wood to lines desired. Care must be taken not to cut into the checkering any more than absolutely necessary. When this operation is completed it will be necessary to refinish the entire stock. You will have to straighten the trigger guard—this is only soft steel on most guns—but on some of the better grades the guards may have been case-hardened. When this has been done it is best to anneal the piece before straightening the guard, as you are liable otherwise to break it in the screw holes. When straightening the guard use a lead or rawhide mallet, resting the guard on a lead block or a piece of end wood. When proper shape is obtained screw the guard into the trigger plate and inlet into the stock. When recheckering, carry the design well back until it meets in a center line drawn down from the end of the tang back to a converging point. It is usually better to remove all the checkering on such a job and place on a new design rather than try to follow the old checkering, as the removal of the pistol grip brings your lines to a wrong position to look well when carried out again.

Reshaping Forearms—Forearms can be shaped to any desired form, particularly the military forearm for sporting use. This is generally easy, for the reason that there is plenty of extra wood to work on. The different kinds of forearms and tips are given in Chapter X and the student may work out any shape he desires, as long as it is within reason.

One often objects to the hand or finger grooves along the sides of the military stock. It is an easy matter to inlay a patch by cutting the grooves out square and about $\frac{5}{16}$ inch deep, and gluing the patch in position. Of course you will match the wood in the stock. Taper the inlay slightly on the sides and ends, so it will tighten into place. The inlay should be just a neat driving fit without any openings on the sides or ends. Glue into position, clamp and let stand 24 hours.

Many make the mistake, when cutting off a forearm on the service stocks, of cutting it just ahead of the sling swivel. This is done in order to have solid wood left where the web of the relieving cuts in. It would be much better to have about 3 inches ahead of the sling swivel. Glue a large enough piece into the exposed opening so that it will be possible to shape this into a neat forearm tip.

Broken Stocks — Repairs to broken stocks will tax the ingenuity of the beginner; you will have a number of such jobs come to your notice, all of which will be different. It is not generally practical to attempt these repairs. Shotguns are the most liable to have their stocks broken, particularly the cheaper grades, where the seasoning of the wood has been hurried and the wood made brash. You will sometimes find that the tang has imbedded itself from the recoil, and by a wedging effect has opened the stock and forced it to spread apart or loose from the action. This is an easy break to repair, for all that is necessary is to remove the stock from the action, spread the break apart, run hot glue into the crack and clamp tight, either in a vise or suitable wooden clamps. When completely dry, drill and counterbore through the solid sections of the stock and insert a 10 x 32 fillister-head machine screw with nut and washer. Counterbore deep enough so that it is possible to fill in both sides with a walnut plug, and glue in position.

Whenever it is possible to get two screws through a broken stock, it tends to strengthen it ever so much more. I have made repairs such as this to trap guns, and after a lapse of years they were stronger than the original stock. Some are not so easy to repair, particularly a shotgun stock that has been completely broken off by a bad fall. I had a Westley Richards gun come in with the stock broken off in front of the comb and splintered out very badly. It was a hammer gun with side locks; the wood was broken even back into the lock cavities. I gave the job up as hopeless and explained the situation to the owner, but he was willing to pay more for the repairs than the cost of a new stock. When I began to collect the splinters after removing all the metal, I found it was a hard matter to match these up on the sides; but the main break was comparatively easy to force together. After having clamped it securely in place, I ran a $\frac{5}{16}$ -inch drill from the trigger-guard cut-out on an angle back into the comb. Into this I drove a hickory dowel and applied hot glue into the ragged edges of the break and clamped tight. I now had the stock together so it was possible to fit some of the larger splinters in the sides. This operation was not so easy, for these did not fit very well and it was necessary to make new splinters and glue them in position as best I could. This required a number of days to do, but still I had several bad openings which could only be covered with a brass plate fitted to each side. So I formed the plates and then cut out the stock so these would just come flush with the wood. I then drilled the left-hand plate and used this as a templet, drilling through the wood to the other plate. Having se-

cured the centers on the right-hand plate, I drilled this and tapped it for an 8/40 screw. I then countersunk the left-hand plate and turned and threaded screws from a brass rod. When I had everything ready I applied melted cement to the cut-out for the plates and put these in position with the screws, drawing the plates tightly together. This I let stand for 24 hours, and then cut off the rods and the projecting screws on the opposite side. After filing down the screws and plates and polishing these I damaskeened the surface and then lacquered them. Such jobs are unusual, but you can see that it is possible to accomplish the almost impossible when necessary. This stock was actually stronger than the original stock.

When bolt-action rifle stocks break through the grip it is better to make a new stock, for these are broken because of an improper selection of wood, the grain at this point not running in the right direction. If a stock splits back of the tang of the receiver, or if you notice the least indication of a split beginning, remove the action and relieve at this point, say $\frac{1}{32}$ inch of wood or more. Then further damage will be avoided. This condition is caused by incorrect inletting of the action, not having fitted the recoil shoulder tightly enough against that point in the wood, and not relieving the radius enough at the end of tang. I had a model 1898 Krag sent in to test and target which showed a small check about $\frac{1}{2}$ inch long running down from the tang. Not thinking anything about this, I started to fire the rifle. On the third shot the stock split straight back over one inch into the comb. It thus became necessary for me to repair this before any further testing could be made, unfortunately at my own expense.

A grip broken naturally calls for a new stock. Of course it can be repaired to give further service for a time, but the recoil will sooner or later break it apart again. However, by coating the broken surfaces with hot glue, and clamping together with all the pressure possible on the clamp, letting stand for at least 36 hours, then drilling from the receiver and guard and gluing in two $\frac{5}{16}$ hickory dowels together with brass plates as outlined in the Westley Richards shotgun, you can get a repair that will prove as strong as the original stock. I do not recommend it, however.

If a split in a high-power rifle stock is due to the tang of the receiver forcing itself into the stock, first repair the break, then look for the cause and remove it. I have found that attaching a shim firmly at the recoil shoulder together with a heavy coating of liquid glue, then screwing the action and guard together, and forcing the glue to fill in all the cavities at the recoil shoulder will make a much better joint.

Before applying the heavy glue, cut off the recoil shoulder just a little with a wide chisel to remove the oily surface so that the dry wood is exposed in its original state. Score the surface lightly so that the glue will be able to attach itself better to the wood.

When stocks show splits lengthwise they can be permanently repaired by forcing the break apart and introducing hot glue in the break. The crack must be forced apart carefully, so that you do not bruise the edges. Also take care not to lose any of the splinters that may come out. These should be kept in position, their ends left attached if possible, and must be coated all over with glue and worked back into their respective places before the clamps are applied.

Perfect contact and tight clamping are the secrets of well glued joints. Merely "pressing the parts in place" as you may have been often told, or binding with twine, will not do. Get plenty of pressure on them and let stand for a day or two.

Removal of Dents—Stocks which have been badly marred by an accident can often be brought back to their original condition by careful treatment. Examine the places to see if they are dents or nicks. If no wood was removed and they are dents, they can easily be removed by raising the grain again to the surface. Heat a flat-iron hot, wet a piece of heavy cloth, and lay over the dent. Take the hot iron and rub it over the cloth. Keep the cloth wet so that steam will form underneath. Repeat this until the dent is raised to the surface of the wood. This method will raise very large and deep dents. Most furniture factories use a steam jet on the dent, but the method outlined here will prove very successful. Deep gouges or scratches require complete sanding down around the point of the nick or scratch.

Steaming out a dent by either method will not hurt an oil-finished appearance except at the place where the dent has been removed. This you will sand with 7/0 sandpaper and re-oil until the finished appearance is returned. A varnished stock will naturally be ruined by the above method, so this will be a good time to remove all the varnish and give the stock an oil finish—provided, of course, the walnut has a good enough figure. If it is a soft plain piece of wood and the firearm does not receive

very hard treatment it will be best to restore the varnish finish.

If a stock receives a very deep gouge which removes the wood, as by cutting on the edge of a sharp object, steaming will never again raise the wood to the surface. Shallow scratches can easily be removed by sandpaper and then the spot refinished. A really bad gouge can be filled with gunmaker's shellac. This you can make from the recipe given in Chapter XXV. Apply a piece of the gum and with a warm iron melt it into place so that the spot will be well filled, first warming the wood in the proximity to be sure of good adhesion. Let it remain until cold and solid, and then rub down to the original finish. Another method of filling in bad gouges on stocks is to get fine wood filings, mix this dust with thin glue such as Le Page's, and press this into the interstices, letting it remain until hard and solid and then finish the same as the surrounding wood. Neither this nor shellac will adhere where there is oil or where the surface has been oiled. In every case you must dovetail or undercut the sides of the hole so that the filling substance will have an anchor in the wood.

Gunmaker's shellac can also be used for filling in around the barrel on the service stock when the top hand-guard is removed; or on the Krag stock where the top hand-guard springs clear the stock. You will find plastic wood recommended for a number of different jobs such as I have just described, but the appearance is very poor when compared to gunmaker's shellac; when the student become accustomed to the latter's merits, it becomes his best friend. Chapter XXV explains this formula and its preparation for use.

Plastic wood comes into use for building up grips on revolvers, bad cuts on the inside of stocks, filling in places where it will not be seen, etc.; but for the better class of work gunmaker's shellac is the only filler you should use.

No doubt there are a number of points I have neglected to cover in this chapter, such as, perhaps, building up stocks for target work. This class of work has endless limitations and must be solved piecemeal. However, from the general instructions I have given one will have a pretty good idea of the *modus operandi*, and by adding a little of his own ingenuity he will be able to meet differing conditions successfully.

CHAPTER XV

Laminated Woods for Gun Stocks

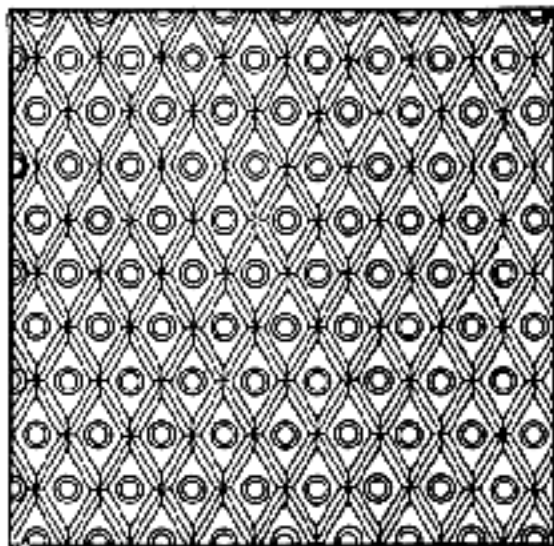

Laminated Woods For Gun Stocks

IN RECENT years interest in stock making has reached a high state of development and the search for a supply of beautiful-grained walnut for the making of rifle and shotgun stocks has reached into the four corners of the world. Walnut is king among the many woods for stock making, but we often find that it is very difficult to secure a beautiful figure on the full length or both sides of a blank without examining hundreds of feet of timber in widths desirable for the making of a stock. The subject which I am placing before the reader is the possibility of laminating woods for gun stocks. It must be viewed from different angles as there are many factors which have to be taken into consideration.

The idea of wood lamination is similar to the veneer process of gluing a thin piece of fine wood to an inferior piece of wood. The manufacturers of such products have developed this to a very high state of perfection. Why should we not extend these possibilities to a gunstock, using three or more pieces of fine wood for that purpose? The actual effect of gluing two pieces of wood together cannot always be the determining factor in the choice of a method. Compare the large wood-working departments of our furniture factories equipped with modern machinery (particularly the planing machines on which it is possible to finish a perfect surface on a piece of wood) with the amateur's small attic or basement workshop. The amateur is quite handicapped when it comes to finishing thin pieces of boards; it is necessary for him to form two pieces of wood with a parallel surface so that when they are glued together it is impossible to see a joint. When the operation is performed by the methods employed with a wood planer, perfect work will result; the beginner will undoubtedly find some wood-working establishment to finish the pieces of wood selected for the operation.

The gluing may be easily accomplished by the student if he has a glue pot and has followed the instructions given in Chapter XXV, explaining the preparation and handling of glue. A thorough understanding of wood and its behavior under various gluing conditions is necessary, but the importance of a perfectly glued joint consists in many other things besides—a perfect surface, correct consis-

tency of the glue at the correct temperature, a scored surface to the joints, rapid work in applying the glue, and clamping the pieces together perfectly tight.

It appears that there was never much attention paid to the lamination of different woods for gun stocks. The apparent inconsistency of the idea on the surface must be excused on the grounds of extreme deviation, but there is no reason why popularity and widespread use of this method cannot be resorted to, particularly when the scarcity of fine woods for gun stocks is so evident.

My first attempt was made on a Stevens single-shot rifle. Two pieces of American walnut were used with a piece of $\frac{1}{4}$ -inch curly maple placed in the center; the white and brown colors between the two woods are very pleasing, especially in the center of the finished stock. Chapter VII offers some very pleasing effects, especially the inseting of the more valuable woods such as ebony, rosewood, amboyan, blackbean, blackwood, maple, mahogany, etc., or in fact any wood the fancy may dictate. For the benefit of those whose choice is restricted, I would suggest using some of our native woods which may be purchased from a local dealer. Glue small pieces of different woods together, using walnut for the outside and 1, 2, 3, $\frac{1}{8}$, or $\frac{1}{4}$ inch pieces of different woods in the center of the experimental sample so that you may form some idea as to just how the stock will look when finished. In most instances, selected woods which will blend well with walnut are the most desirable; they are the darker varieties. The light-colored woods such as maple or satinwood form too startling a contrast; however, these combinations are a matter of taste. Figure 105 suggests the methods employing the different kinds of woods for a laminated gun stock and forearm.

Altho this practise is an artificial means of selecting the best parts of a blank, the idea of joining woods is old; curiously, very little has ever been done to apply the principle to a gun-stock blank; nor have I ever seen any articles published on the subject. For the student who is reaching out to create things just a little different, this field should open great possibilities for practical experiment. The general commercial practise of gluing woods

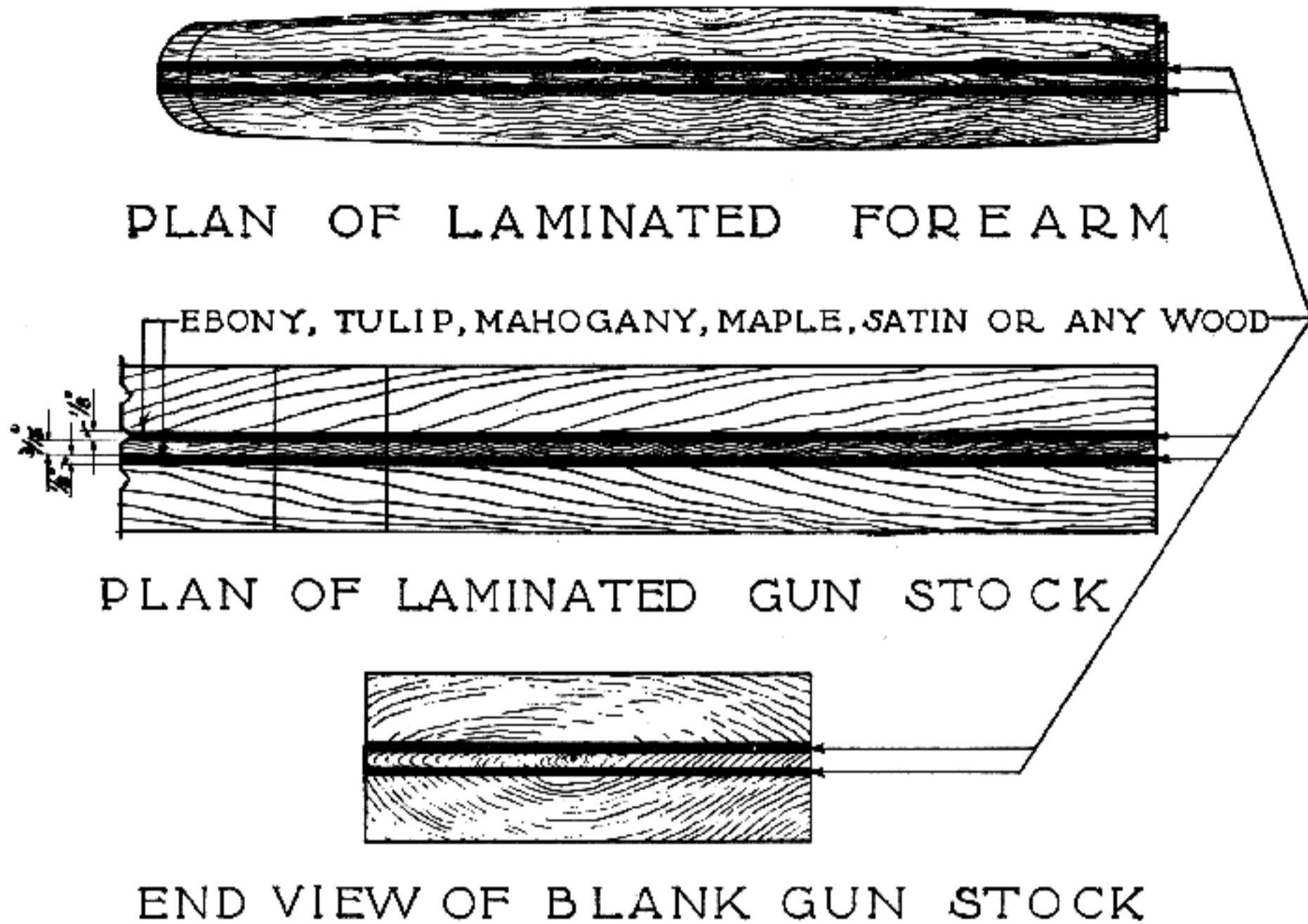

END VIEW OF BLANK GUN STOCK

Fig. 105

Lamination of wood for gun stocks

together antecedes the present so far that it cannot be inferior to what one might expect in a piece of furniture as old as the manufacture of wood products.

So far as strength is concerned in a laminated gun stock, I am of the opinion that it would probably be much stronger than any one-piece stock. The first impression is that it would lack the fine appearance of a solid stock, and that exposure would cause warpage and render it unserviceable under various circumstances. This supposition is only natural, but I can assure you that you will find the laminated stock as strong as the solid stock, and with less warpage; for the wood is not running all in the same direction, nor is it from the same tree or species; when such a change takes place, one wood will have a tendency to compensate for the other running in the opposite direction.

As you are well aware, linseed-oil treatment is one of the best a rifle stock can undergo. It does not matter what suggestions are given and experimented with, in the end you will find the warm linseed-oil treatments the best.

As a matter of experiment, take a number of stocks, both solid and laminated. Make elaborate gauges to test the warpage, and you will find warpage existing in all stocks, some more than others. Test them at two-week intervals, and even tho they are kept in a room where the temperature can be held at a given point, you will be

surprized to learn that they have warped decidedly.

During the oiling and finishing period you will often find that a stock has changed to such an extent that the metal parts have large openings because of conditions which cannot be controlled. Quite frequently the warpage would be enough to put a strain on the barrel, bending it, if allowed to be assembled in that condition. The aim of iron sights will also change with the barrel. Such slight strains will scarcely be noticed by the sportsman who uses iron sights, but they will often be noticeable to the one who uses telescope sights, especially those that are fastened to the receiver only. Many telescope mounts are blamed for the changes in their settings, particularly those of the Niedner design, when the real cause is warpage of the stock.

You may find one stock in a hundred that will have such grain and density that it will warp so as decidedly to change the elevation and windage of the rifle and be in such constant state of change that the sportsman can never do very good shooting. The rifleman should have no trouble, provided the rifle be properly bedded in the stock at the start, the stock properly treated with linseed oil, carefully guarded from exposure, and occasionally re-oiled. Naturally, if a rifle is laid on its side on the damp ground for several hours with the hot sun shining on the other side, or if it gets thoroughly wet in the rain and is not promptly dried off and oiled, the owner will probably experience a

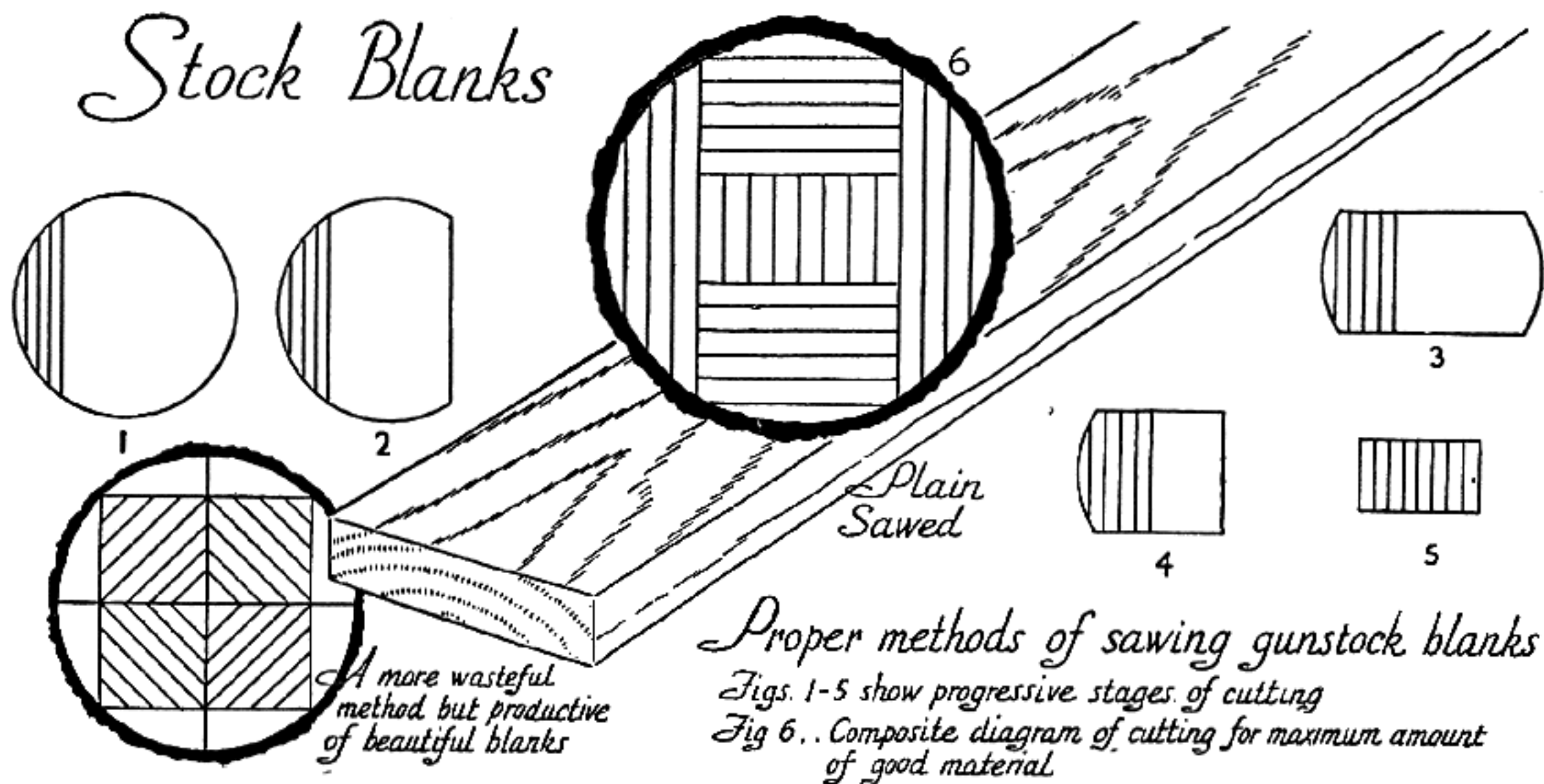

Fig. 106

Correct way to saw gun-stock planks from log

considerable amount of trouble. All the bad scores, however, cannot be laid to a stock, whether it be solid or laminated, for a number of other faults can be found to produce the same results.

Structure of Wood—The chapter on the selection of woods is very complete, but in this chapter different points should be brought before the reader so that no misunderstanding will take place. It should prove especially helpful to those who prepare their own seasoned lumber for the purpose of laminating a gun stock. The process of seasoning and correct cutting of wood for gun stocks is perhaps least understood by those who cut wood from the back lot or forest.

Seasoning means to make fit for use; therefore, in wood it invariably means the removal of some of the moisture, or drying. With respect to some other commodities seasoning may have a different meaning, as the seasoning of food with salt. The removal of moisture from stock blanks is usually done by exposing the blank to outdoor atmospheric conditions or to the higher temperature of a dry kiln. A great amount of wood is air-dried only—especially that which is used for gun stocks—and put under proper cover with a free circulation of air.

This information will not only be of immediate help to the practical man whose duty it is to seek something a little different, but will enable him to select the finest parts of a walnut blank to make a gun stock without paying an exorbitant price. It is hoped that these suggestions will arouse the interest of the student so that he will do some intelli-

gent experimenting on his own account. In so doing he will not only develop efficiency but change a subject into an interesting and challenging opportunity.

The next question for discussion is the selection of blanks. This is not directly understood by many who cut their own blanks for gun stocks. Because of the presence of medullary rays and annular rings in wood, it may be cut into blanks in two distinct ways. It may be cut parallel with the rays across the rings; that is, from the bark toward the center, producing what is known as radially cut, quarter-sawed, or edge-grained blanks, or it may be cut at right angles to the rays or tangent to the rings, producing tangentially cut, planed, sawed, or flat-grained blanks, as illustrated in Figure 106. Here is the correct method to cut wood from a log for a gun stock blank or pieces for the lamination of a gun stock. Figure 107 shows the quarter-sawed method of cutting the log, but this is not desirable for the blanks used for gun stocks.

The plain-sawed planks will dry more rapidly than the quarter-sawed, even under the same conditions, because the purpose of the medullary rays is to conduct moisture or sap across the grain. Timber is composed very largely of organic matter, the proportions reaching to a high percentage in some woods. The organic matter consists chiefly of cellulose, and it is utilized for building up the cell walls. The cells are filled with protoplasm, commonly called the "physical basis of life," which forms the vital element in both animal and vegetable existence. The protoplasm is gradually absorbed by the process of adding more thicken-

ing material to the cell walls; eventually the cellulose becomes converted into lignin or wood fiber and matures into true wood.

The result of this preponderance of organic matter is that timber becomes peculiarly liable to decay once it has been felled and its life destroyed. The decay is accelerated if the tree is felled during the summer months when the cells are full of sap; this causes fermentation to take place in nearly all kinds of timber. Felling should only be done during the time when sap is dormant; this period extends from autumn to about the end of March.

Among the main sources of trouble will be shrinkage and swelling, which will occur in moist climates and when two or more pieces are glued together; if the contraction and expansion are uniform throughout the wood employed, comparatively little trouble will result. On the other hand, checks and even the wood working away from the action may cause the wood to become distorted in shape when such stresses are set up in the glued pieces. Therefore, the correct seasoning must be given the wood before attempting the lamination of a gun-stock blank.

End Checking—When preparing the blanks for stock work the ends should be protected from "checking." The checking of blanks used for gun stocks is caused by two things: (a) uneven drying; the ends of timber in a pile dry out more rapidly than the portions farther back because the end

grain gives off the moisture more rapidly and also is exposed to the drying influence of air which causes severe end-checking; (b) tangential shrinkage; this is greater than radial and therefore blanks containing pitch centers will check because the wood dries more along the rings than toward the center. In blanks cut through the center, the halves can cup and thus reduce the checking. When plain sawed lumber is held flat so that it can not cup in drying, it is very likely to check along the middle.

End-checking can be reduced by coating the ends of the blanks with some moisture-retarding material such as linseed oil and barytes, or a high-grade spar varnish and barytes. One or two parts of lamp-black may also be added if a black coating is desired. The protection of the wood means the long life of any gun-stock blank regardless of the nature of its structure. The proper seasoning of wood is the first consideration, whether it is a solid piece of wood or a laminated piece, regardless of the number of pieces joined together. Such an idea may meet with many obstacles, mainly criticism from different authorities on the subject of laminated gun stocks, but I can see greater possibilities when carried out in better woods and with pieces made beautiful in color contrast. The student seeking results can well afford to improve on any experiments carried to a higher perfection of beauty in the selection of desirable and valuable woods from the earth's four corners.

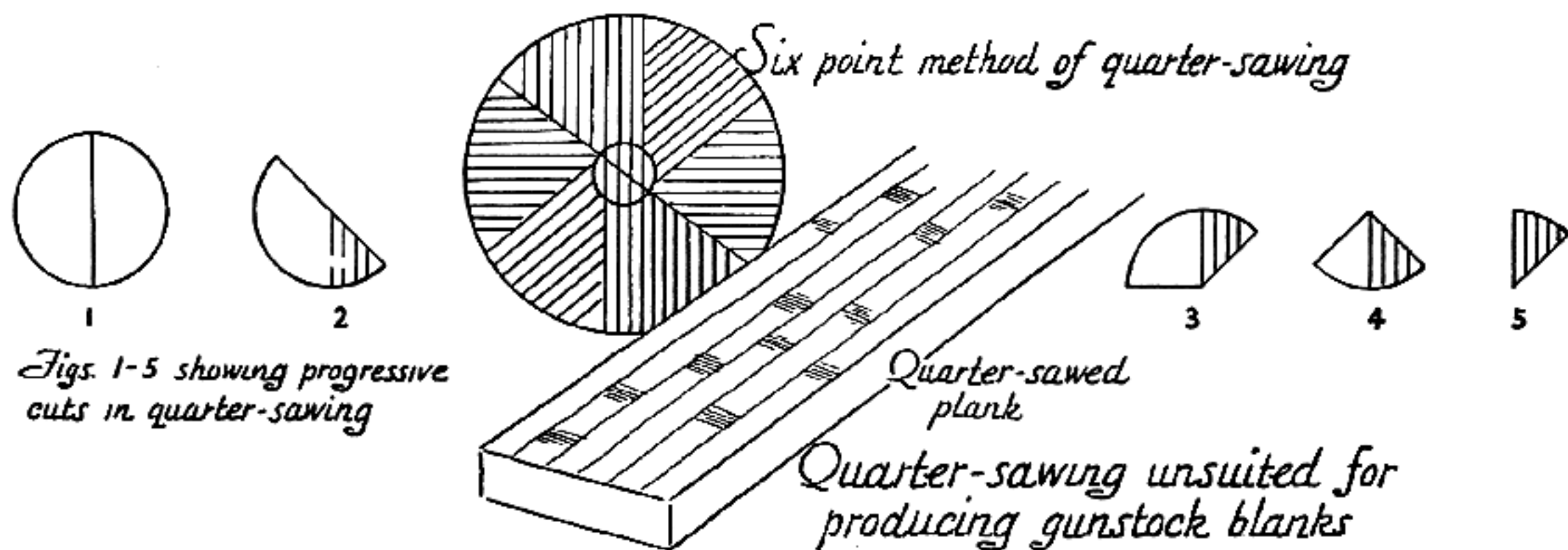
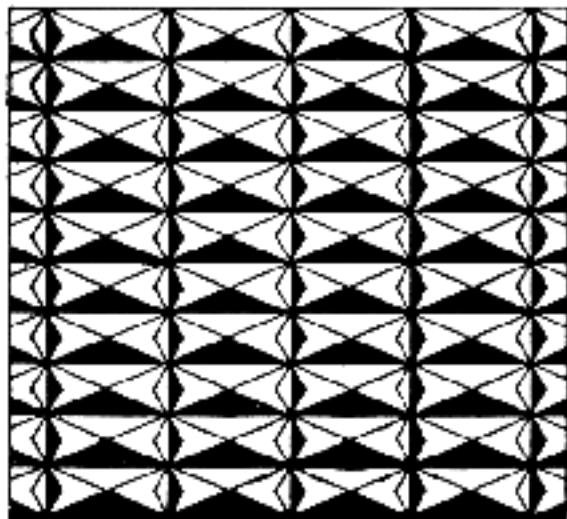

Fig. 107

Incorrect way to saw gun-stock planks from log

CHAPTER XVI
Modernizing
Military Small
Arms



Modernizing Military Small Arms

I MIGHT as well confess right away that I am in favor of the bolt-action rifle. This seems perhaps unpatriotic and un-American, for such a preference seems to ignore the long series of world-embracing steps that are inseparably connected with the American rifles, none of which are bolt-action. Has not the name of the creator of more than one American rifle become synonymous with the rifle itself? To say a man was armed with a Winchester or a Colt does not require that we add the word rifle or pistol. These proper names have become common nouns in the language.

My preference for a bolt-action rifle is based on several reasons. In the first place, I am a stickler for extreme accuracy. To get this one has to have modern ammunition, and both demand this kind of action. In the second place, no form of action permits greater adaptation; and this, to the shooting gun maker, reveals endless possibilities. Please do not think for a moment that I do not perceive and extol the good qualities of other kinds of actions for specific purposes. In our Eastern "bush," when one's quarry is deer, what could a man have better than a quick, light-lever-action Winchester? Or, in a big-game rifle, is anything as good as a double Holland & Holland with shotgun action? (See Figure 108.) Other instances spring to mind as readily and surely.

the latter because of their inexpensiveness. The Springfield also, because it is designed exactly for the .30-06 cartridge, will always have a great appeal, for this is considered the world's best long-range load, and even now this particular barrel and caliber seems to handle reduced short-range loads better than any other size.

The United States Government, in making this rifle available to its citizens, has conferred upon them a priceless boon. One has only to become a member of the N. R. A.* to secure this fine rifle and ammunition at cost. The government has even gone further than this. It has actually gone to the trouble to provide its military arm in sporting stock and sights, and this not only in the 03-06 caliber but in 22 L. R. also. Here we have the makings for the best sporting rifle available. Second only to this, is the Enfield 1917 model, made for use in the Great War by our leading manufacturers and taking the same cartridge. This has an added advantage to the poor man because of its low price. The Lee Enfield, made also by the British, and the Canadian Ross rifle, both taking the .303 British shell and having ballistics similar to our .30-40 Krag cartridge, make very useful arms. Last but not least is the good old Krag, superbly made in the government arsenals, and making in sporting dress as good a rifle as most

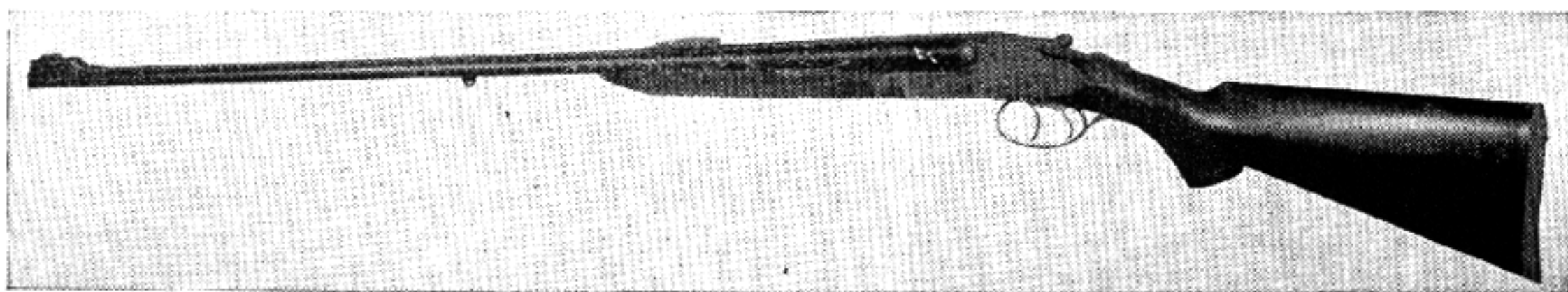

Fig. 108
Caliber 350-2 Rigby double-barreled rifle: a true work of art

While all our important American firearms manufacturers make bolt-action rifles, and good ones, the amateur gunsmith will generally use in his experimenting and remodeling, a military rifle, either the U. S. Springfield, an Enfield, or the Mausers, Mannlichers, and Nagants of European manufacture. The former because of their great excellence,

men would desire. With all this excellent fare, few will desire to go further; still, for those with abnormal appetites, a new range of possibilities is available by fitting barrels of other calibers to these self-same rifles such as the 6.5 and 7 mm., which are also world popular.

* National Rifle Association, Washington, D. C.

Let us start by describing how to remodel a military rifle for sporting use, retaining most of its parts. We shall first dismount it, separating the metal parts from the stock. This will give us greater freedom in the use of our tools. Let us take the stock first and see what we can do with it. The first thing is to remove the excess oil with which it has been treated. This is best done with gasoline. You will notice that this stock has been made for hard service rather than beauty and is a compromise in dimensions, being built to accommodate all sizes and kinds of men. You will find, in most cases, that the butt stock is too short. You might lengthen it with a piece of wood neatly applied under the butt plate, or by a thick aluminum plate; but really the easiest way, and a way that adds another great advantage, is by means of a rubber recoil pad. This also does away with the patched-up appearance that the other methods cannot avoid.

You will note now that the "hand-hold" or grip of the stock is pretty large and that the comb of the stock is rather low. Both can be helped with the spoke-shave, for in reducing the size of the hand you will get the apparent effect of raising the comb. If you have a good shotgun, use it as a guide to your shaping. You will not be able to get all you may desire in shape, but you will be able to make a marked improvement.

You will doubtless decide that you would prefer a fore-end of sporting length, so you will cut off the forestock ahead of the rear barrel band. This will reveal an opening between barrel and stock which you probably did not suspect. You can seal this by fitting a piece of wood into the space; but there is a better way, which is to fit a fore-end tip of contrasting wood or horn to the end of the stock. The method of doing this was fully described in the chapter on stocking, to which you will refer. If you decide on a tip made of wood, make it of hard maple. This you can stain black; at a short distance it will closely resemble the higher-priced and harder-to-fit horn. It would greatly help the appearance and grip of the gun if the grip and fore-end were checkered, but I do not like to advise you to attempt this until or unless you have experimented with this operation. It is also fully described, with its tools, earlier in the book. Let us say that it is much harder to do than it looks, and that preliminary practise on scraps of hardwood is advisable before tackling a stock.

The removal of the hand guard has also revealed another hidden surprize. This is that the barrel has not been smoothly finished except where

it is exposed. This roughness cannot be perfectly removed except by smoothing and polishing in a lathe, but you can do a very respectable job by draw-filing. As you have only a short piece to do, this is the method you will use, following it with emery and the finer abrasives until you are satisfied. This will require that you reblue the barrel, so judge first which you would rather have, the tool marks or the coat of bluing.

Our next consideration is the matter of sights, a very important one. No rifle is better than its sights. The sights on the military rifle as issued are not suitable for hunting or even the best target work. The front sight will, of course, answer, but here improvement is easy and inexpensive. Lyman makes an interchangeable sight in several styles that can easily and quickly be substituted.

The rear sight is rather more complicated, but you can make a number of combinations on the fixed base of the Springfield, especially if you are a young man with normal sight and can get a clear image with a sight as near your eye as a sight placed here will necessarily be. You can easily determine this by taking any common leaf sight or a piece of metal filed to this shape and sliding it along the barrel as you hold the gun in firing position. When you reach the point of perfect definition this will locate the sight position. The height will be determined, of course, by the height of your front sight and the range. If you find then that you are able to use the fixed base on the Springfield, you will remove the present sight from the base. This is done by completely turning the windage screw until the sight is turned out and can be lifted off the pivot lug or projection.

You will now have a chance to use your ingenuity in designing and making a leaf sight, or a set of them, which can be affixed to this base. A series of separate leaves filed to 100, 200, and 300 yards elevation are really the best, but unless you are prepared to make the two folding leaves spring-controlled, so that they will not flop in use, you will be best advised to secure a rear sight with elevating ladder such as is used in the generality of hunting rifles and use this as a base for your sight. If you intend, in addition, to use a Lyman peep, you will find that marble makes an adjustable sight, the ordinary standing part of which can be turned down at will. In a later chapter, I shall describe the many varieties of sights and how they can be made completely; if you are ambitious to go the whole way, study that chapter.

The use you are to make of your rifle will determine your sight equipment. Some of my good friends who are real sportsmen think that a rear

barrel sight should be ignored, and their own rifles are consequently devoid of them. In this, I do not agree. There are times when a rear barrel sight is the best bet, and furthermore, they serve two other functions—they serve as a spare sight should the fragile peep sight be broken, and they also serve as a check-up for elevation. This is a mighty useful adjunct, for somehow one's hunting companions do like to play with one's sight-adjustment screws in the evening at camp. A glance over one's barrel sight instantly detects any maladjustment.

It is a mighty good plan, in off-hand game shooting, to adopt the principles of the wing shooter; that is to fire the gun the moment the rifle touches the shoulder. Any poking or changing aim at moving game means the game will usually keep right on moving. This necessitates a "point blank" sight position adopted and made constant. This you should do before you ever enter the woods. All your adjustments will now be a matter of instant judgment based subconsciously on the distance to be met. Both the aperture sight, if it is a ring-type eyepiece like the standard Lyman, and the plain bar rear sight are equally quick and suitable for this kind of snap shooting. The eye does miraculous things, and one of them is the instant automatic centering in an aperture if you do not consciously interfere with it. Incidentally, I strongly advise that a rear sight be straight across its upper surface and not cut to a V formation. A light platinum line running vertically at the center is a slight help perhaps, but this line must terminate $\frac{1}{16}$ inch from the top or it will blend with the front sight and destroy all certainty of elevation. An ivory pyramid inlaid in the face of the leaf with its apex terminating at the same place is also excellent. However, your eye, if you trust it, will do the trick quite unaided.

For purely target work at known ranges, a different sight equipment is necessary. Here doubtless there is nothing equal to a Lyman sight adjustable to both elevation and wind allowance and capable of the finest graduations. A disc used in the turret will cut off disturbing light rays and thereby give sharper definition. There still remains the increasingly popular scope. I shall refer you to Chapter XVII for this and its uses, as it is too technical a subject to treat with the briefness necessary in this chapter.

We now must think a moment about our trigger pull. Most military rifles have poor trigger pulls. This is brought about by the necessity of safety and rigidity, features that must always be inseparable in military operations. All modern military

rifles have therefore a "safety" or preliminary pull. In target work and in the battlefield this offers no objection—in fact, it confers a benefit; but in the hunting field it is not quite satisfactory. Your trigger, however, can be adjusted to the latter purpose. I don't want you to do it, for it is a delicate job and calls for a lot of experience. You had better send the rifle to an accomplished gunsmith, telling him just how many pounds trigger pressure you prefer. A trigger is something we must take no chances with. I fit, when requested, an adjusting screw in the guard of a rifle, which can be regulated to a desirable pull and securely locked in position. This is an expert job, but it is the real solution of trigger adjustment.

Everyone would find pleasure in owning a sporting Springfield, but many riflemen feel they cannot afford to have a service arm remodeled. The beginner will immediately visualize the finest remodeled gun that is possible to build with the base of a military arm for the foundation; but be contented for a time with the rifle in its present condition, until you lay plans for its future development.

We have a number of military arms to work upon as well as the Springfield model 1903 and Enfield model 1917. Perhaps there are some who are fortunate enough to have one or several of the following military arms in their possession: the British Enfield model 1907, French Lebel model 1886 or 1893, German Mauser model 1898, Austrian Mannlicher model 1885, Russian Nagent model 1891, and Japanese Arisake model 1905 (a number of these were sold in England about 1925), Italian Paravici caliber 6.5 mm., Belgian Mauser model 1889, Ross model No. 5 British caliber .303 and .280, or any other rifle classed as a military arm. The next question is that of ammunition. The model .30-1906 full metal-patch ammunition can be secured by members of the N. R. A. This, of course, is the logical cartridge to choose for the rifle that will handle this ammunition.

The 8 mm. cartridge is a standard for use in the German Mauser military rifles and is made by our leading cartridge companies. This, together with the better 7 mm. and .303 British ammunition, can be secured in any part of the world. It is possible to secure all kinds of cartridges for foreign rifles through some of the import houses of New York, but from the standpoint of accuracy and economy the .30-06 cartridge is the best for the American experimenter and rifleman. Of course, if you should be located in some other part of the world, adopt a cartridge which is standard there and can be secured as easily and economically as the .30-06 ammunition.

Whenever one of the other military arms is in your possession it is well to experiment in order to understand its peculiar characteristics.

When a customer comes in and wishes leaf sights fitted to his rifle, I always try to get an idea of the section of the country in which he wishes to use the weapon. This gives me an opportunity to explain the advantages and disadvantages of the different combinations. Nearly everyone will prefer some particular combination, and I naturally have to give a person what he wishes, regardless of the suitability or not. This is unfortunate. The British gunsmiths make the finest kind of leaf sight. It usually has a wide V-notch, and in addition to the standard there are folding leaves equipped with retaining springs. These have a vertical platinum line designating the center. You realize the suitability of these sights on a heavy double rifle, particularly when faced with charging dangerous game, for they are lightning quick. Their front sights do not usually please me. They are too fine in sections, and therefore frail. It seems to me that they are next to useless for hard work and rough usage, as they are easily bent and displaced, and this puts the rifle out of commission. Hunters carry extra front sights in a receptacle in the stock, but how much better a solid steel blade of ample size would be!

Then we have the peep or aperture sight. So much has been written on this subject that I do not feel justified in explaining its advantages and disadvantages. A separate chapter will be devoted to this subject alone. In my opinion the aperture sight is the quickest sight there is, and if there were no unfavorable conditions it would be perfect. These are useless, however, in rough mountain work and in jamming in and out of saddle boots, because of their delicate mechanical adjustments. The fine accuracy demanded on the rifle range is the proper and obvious field for them.

The choice of a front sight requires as much thought as a rear sight. Chapter XX, Volume II, gives you a number of ideas on how to make these. I have made so many different kinds for customers, that it really is a hard matter to say just what is best. From the illustrations, one can pick the one which is best suited to his individual preferences.

There are thousands of men, some of them not gun cranks, who pick a rifle to pieces the moment it gets into their hands. The student should never develop into this class. The men who designed the rifle did so for some reason, knowing from long experience just what was best. So don't rush in and try to change everything for some fancied advantage until you are sure that it outweighs the

disadvantage that should come up under other conditions.

A very suitable subject to work upon and express your ingenuity on is the Russian 7.62 mm. (caliber .30) Nagent rifle. A brief history of it and of how a large number of rifles of this model came into the possession of the United States Government may be of interest.

At the time of the World War, the Remington Arms, the Winchester people, and the New England-Westinghouse Company had large contracts with the Imperial Russian Government for a supply of these rifles. When the Union of Soviet Republics took over the Russian government, these three companies had several thousand finished rifles on hand. These the United States Government bought at a very reasonable price, intending to use them in the drilling of recruits, as the supply of Springfields was insufficient. With the war over, the government had no further use for them, and the D. C. M. was therefore instructed to dispose of them. They are good subjects for the amateur to work upon, for they can be converted into a very fine hunting arm, as the foundations are there, and they are strong and reliable.

This rifle uses a rimmed cartridge firing a bullet of 150 grains weight. The caliber is 7.62 mm., which is in fractions of an inch .2999 or .30 caliber. It gives an initial velocity of 2900 ft. sc., so you see it is ballistically up to date.

The Remington Arms and the United States Cartridge Companies both make the ammunition for this rifle. The .30-caliber Springfield service bullets and the .30 caliber 172 grain boat-tail bullets work very well in this rifle. The groove diameter is a little larger than the Springfield because it was necessary to give a somewhat greater manufacturing tolerance in the hurried manufacture of the rifles. This is likewise a fault in the model 1917 Enfield, which was also made by the Remington Arms Company.

The bolt handle of this rifle extends rather awkwardly. It can be altered to a more normal position, but this is a job rather beyond the ability of the beginner. How it is done is explained in Chapter II, Volume II.

The beginner has a wide range of possibilities in the remodeling of this rifle. He can build up and reshape the old stock as described in Chapter XIV, or for experience he can make a complete new stock. The barrel can be shortened to any desired length. Sights can be fitted (see first part of this chapter). Lyman makes an aperture rear sight adapted for this rifle, and this simplifies the question of sights. When all the changes are made,



Fig. 109

An amateur's gun shop. Dr. E. J. Witzel in a corner of his basement. The attic, the woodshed, and the basement are rivals of the laboratory in this fascinating work

the metal parts will be reblued and the wood polished. The beginner will be surprised when he sees one of these rifles properly worked over, for he will find that he has a very good sporting arm. See Figure 109 with one on the bench.

The model 1917 Enfield rifle is one of the war-time products and is also sold through the D. C.

M. to N. R. A. members. It costs \$7.50 in used condition and \$20 new. These were made by the Remington Arms Company for the British .303 cartridge, and for the .30 U. S. cartridge. This rifle has some good features, and can be made up into a very serviceable sporting arm. The Remington Arms Company is still using the receiver

of this rifle in its sporting models, so when you are in one of the large sporting-goods stores, ask the clerk to show you a Remington Model 30; this will give you some ideas which you can utilize. The military model as issued by the D. C. M. is an unsightly affair, but do not be discouraged. The same suggestions apply in this case as in that of the Russian rifle. The rear-sight base is a part of the receiver on this model and so must be removed by grinding. New sights, either leaf or aperture, can then be applied. By filing off the present rear sight, a Lyman .48 can easily be fitted to the contour of the receiver on the right side.

You will not be as well satisfied with this rifle as with some of the other military models, but your main problem is to gain experience. Do not allow likes and dislikes to influence you greatly, until the time comes when your judgment is worth something. The Enfield is the most reasonable-priced rifle handling the .30-06 cartridge. Some of the barrels are oversize in the bore as much as .002. This was due to wartime production, and only fair accuracy can be expected. The rifling has the British left-hand twist instead of the right-hand twist of the Springfield.

After the war a number of these barrels were sold to riflemen as well as gunsmiths, who sold them as new barrels. Since they all had a left-hand twist, a few were detected. One in particular that I examined proved to be a Remington barrel. The party who had restocked the rifle and placed the barrel into a Springfield action excused himself on the grounds that he only made barrels for very close friends.

One firm who advertised a great deal right after the war used a number of these barrels also, but I do not know the excuse they gave for using the left-hand twist. Their price was \$80 for a barrel with a makeshift rib, and \$50 for a plain barrel. One man paid \$80 for one with the rib; after the third shot the rib came off. Because of this unexpected misfortune, another Remington barrel was

discovered, which was sold for five cents per pound.

One good feature about the model 1917 rifle is the bolt with the safety feature on the side and in such a position that the thumb of the right hand can operate it very readily. Also the turn down in the bolt handle which permits a low mounting of a telescope without the necessity of bending the bolt handle. This is an advantage over most other military rifles. The beginner will find that it has taken a considerable amount of hard work on this rifle to bring it up to the ideal he has set, but he will find he has a good rifle and he will like it better as time advances.

Figure 110 illustrates what can be accomplished with these arms to make them look more like sporting rifles. Since the D. C. M. has placed these war arms on the bargain counter—the proper place for them—the amateur gunsmith has a very favorable subject on which to try his experiments. These recommendations for the remodeling of these arms are only the foundation of the possibilities for the ingenious student. New fields will be opened for the special application of sights, both iron and telescope. New stocks will be designed, as well as special sears and set triggers, and many other improvements that cannot even be enumerated. The actions can be made to handle various calibers of cartridges as well as the standard for which it has been designed. However, with these few suggestions, I know no excuse is needed for emphasizing again the possibilities of the built-up stock as suggested in Chapter XIV.

From the amateur's point of view, it is a difficult matter to draw any radical conclusions as to just what method he will take to bring out the real merits of such a rifle. He may follow the exact instructions as given in these chapters; then again he may have better ideas, and so he may do just what he wishes, providing he does not overstep the bounds of safety.

A number of the Mauser military rifles were

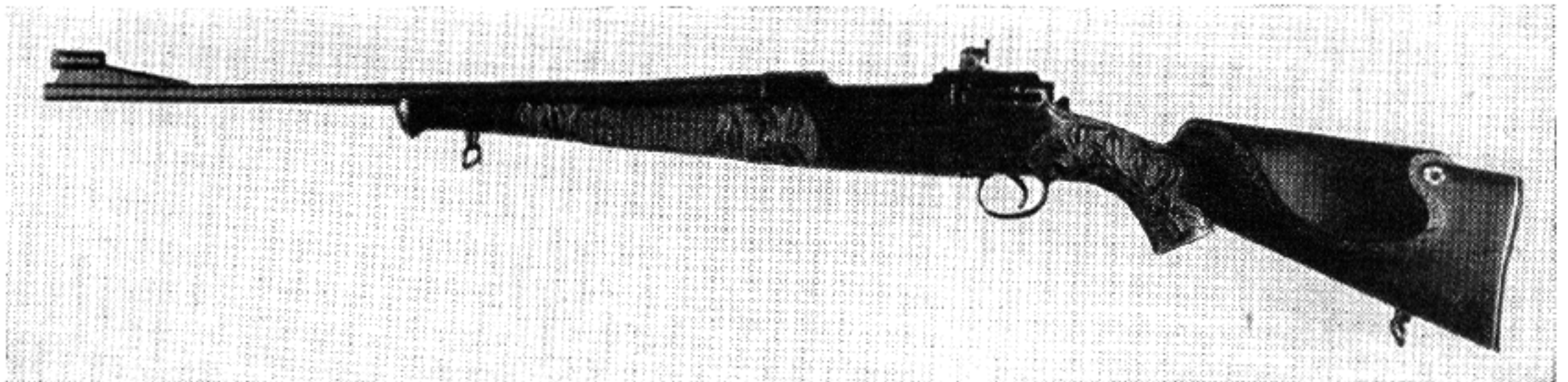

Fig. 110

An amateur's first attempt at remodeling a military rifle. A Model 1917 arm was selected, and Mr. William Clark, a very promising amateur, checkered and carved the stock as well

brought over by the returning troops. These were picked up on the battlefields and preserved as war relics. The action of these rifles is very good. In fact the Springfield is a Mauser. The stocks and barrels are useless, but a new barrel and stock can be made and you will then have a most excellent rifle for the model 1906 cartridge. It is necessary to lengthen the magazine a little, as the German 8-mm. cartridge is about $\frac{1}{8}$ inch shorter than the .30-06 Springfield cartridge. The magazine is cut out at the rear and will allow the .30 caliber to clear, with $\frac{1}{32}$ inch to spare. You have a magazine that will feed the model 1906 cartridge as well as in a Springfield action. The bolt head has the correct recess and takes the .30-06 cartridge perfectly. The bolt handle stands at an awkward angle but can be bent down; the under side of the knob may be ground off and then checkered or matted. A similar rifle when restocked and fitted with all the necessary trimmings will cost you \$200 or more in New York. New Mauser actions cost \$50, and whenever it is possible to secure a Mauser action reasonably, or even the rifle complete, always pick them up, for some day you can make them the base of a fine sporting arm.

Ross model No. 5 caliber .303. The Ross action is what is known as a straight-pull action. In other words, no turn-down of the handle is necessary. The bolt operates inside a spirally fluted sleeve, which engages into corresponding recesses in the receiver. This furnishes the locking movement. These rifles were made by the Ross Rifle Company of Quebec. Sporting models were made as well as the military rifles. The latter were used by the Canadians prior to the World War. This rifle is now obsolete, and I cannot advise the beginner to experiment with it for the reason that so many accidents have resulted from blown bolts. This was caused by an improper insertion of the bolt after removal. A simple lock can be fitted which will prevent this from ever recurring; I hesitate to fire the rifle until this has been done. There are still a number of these rifles in the hands of American sportsmen today, but they have lost their popularity because of this one fault. The rather complicated action, which is easily clogged with dirt, made it unsatisfactory in military operation.

Japanese Arisake model 1905 6.5 mm. A number of these were made up by some of the British Arms Companies for the Japanese Government during the Great War. It makes a very light rifle when restocked and fitted with better sights, and is a good serviceable arm. Very few came into this country, but any rifleman who is fortunate enough to secure one will derive good experience in remodeling it. The cocking piece resembles

the Russian Nagent. It has a fine action, and a good trigger-pull can be secured.

Lee Enfield caliber .303. This is the service arm of the British Army. It must be secured in England or Canada, and is sold to members of the N. R. A. over there. This rifle is to the British what the Springfield is to us. It has given wonderful service all over the world wherever the British flag is flown. It can be made up into an excellent sporting arm when restocked and fitted with suitable sights.

All military models have a world of merit which the student should become familiar with. These arms were designed for war purposes, yet when converted into sporting arms in an experimental way, they give the beginner technical knowledge, and a foundation to carry out advanced ideas to suit some particular purpose. It is from the ideas of a number of individuals that the fine results invariably come.

The 1873 Model Springfield caliber .45-70. This rifle is one of a number which you can class as the poor man's rifle. It is still available to members of the N. R. A. and costs \$1.25 plus express. It has been obsolete for a number of years. The .45-70 cartridge is still one of the best on game at short range. It has great knock-down power. The rifle has a barrel 32 inches and the carbine 22 inches in length. The military cartridge loaded by the government consisted of a 500-grain lead bullet, propelled by 70 grains of black powder. This gave a muzzle velocity of 1200 f. s. and a chamber pressure of about 25,000 pounds per square inch. The barrel has one turn of rifling in 22 inches. The Winchester Repeating Arms Company and the Remington Company make this ammunition in various weights of bullets, such as the 500 grain, 405 grain, 350, and 330 grain. I would advise the student to reduce the barrel length to 24 or even 22 inches. This will give the rifle a better appearance and it will handle better. The stock can be worked over and greatly improved.

It will be necessary to remove the upper tang and weld a piece of cold-drawn steel to it as a base if one wishes an aperture sight attached. The Lyman No. 103 for the model Savage rifle will answer the purpose very well. If leaf sights are desired, these can be mounted together with a front-sight ramp. The design of this rifle permits a low mounting. The hammer can be reduced in size and improved in appearance by grinding away the back and the lower part. You can further skeletonize it by drilling holes in the wide flat part and elongating these holes with a round needle file. If one wishes to restock the rifle or inlet a comb and

pistol grip, the guard tang can be cut off at such a distance as will enable you to insert a grip at the proper place. The very wide trigger guard and the trigger can be reduced in size by filing and then case-hardening all parts. The forearm may be cut off above the sling swivel—this together with the upper tang will be quite sufficient to hold the barrel in place. If you wish to restock the rifle completely, a wide band with a swivel bow can be fitted in the proper location.

Save the end of the barrel which you have cut off and make an auxiliary chamber out of it to shoot the .45 caliber Colt single-action ammunition. The .45 caliber cartridge for the single-action Colt revolver measures .472 in diameter and is suitable. Chamber the end of your auxiliary to this cartridge size, counterboring it so that the head comes flush. Then turn the outside to the size of the chamber. The auxiliary will be of the same length as the full-sized case. As you have a considerable length of barrel left over, it is best to make two or three of these auxiliary chambers to use in place of the heavy-loaded standard cartridge. This sub-load gives a very fine accuracy at short ranges and also gives the user practise in locations which should be impossible with the standard cartridge.

As this rifle action was designed to make it possible to convert existing muzzle-loading arms into breech-loaders, it can be turned back into a really fine muzzle-loader. Cut the breech off where it

for the percussion cap. Lighten the hammer as described in the instructions on restocking other rifles; also the trigger guard, trigger and tang. The butt stock can be altered to suit your ideas. One trouble you will experience is in locating the nipple in the nipple holder. It is necessary to heat the hammer and give it an offset to the right, so that the hammer will strike the center of the nipple instead of at the joint between the holder and barrel. The Lyman Gun Corporation will furnish a bullet mould of correct size, or you can make a suitable mould from the instructions given in Chapter XXIII, Volume II.

The making of a .45-caliber muzzle-loading rifle will suggest to the student the idea of making up a muzzle-loading shotgun from this rifle. It can be made either 12, 16, or 20 gauge, obtaining and adapting a model 12 or 97 Winchester shotgun barrel. The forearm will be cut off to a suitable length and a forearm stud made long enough and wide enough so that a $\frac{1}{2}$ -inch hole can be drilled through and tapped on the under side for a 10-32-inch screw. The large hole is drilled so the ramrod will pass through. The 10-32-inch screw with a fillister head is to hold the forearm in place. The stud must be secured in a shallow dovetailed slot in the barrel, or if you are competent to sweat it on, it will be better secured this way. Before cutting out the channel for the barrel, bore out the hole for the ramrod. If you wish to put in a brass tube, allow for this. Figure 111 will show what is

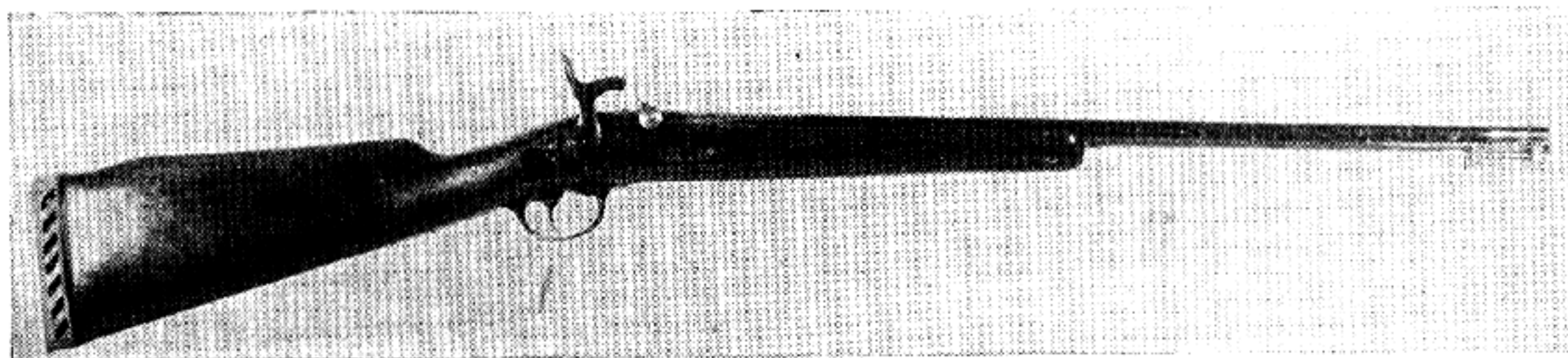

Fig. 111

Muzzle-loading shotgun, 20 gauge, made from a caliber-45 Model 1873 Springfield. A Model .12 Winchester barrel was used, and a special breech plug imbeds the tang in the handgrip of the stock

screws into the receiver and fit the upper tang or a new breech plug into the barrel. Make a nipple holder and a steel nipple from tool steel. Harden and draw the temper of these to a dark straw. Fill in the space formerly occupied by the receiver with walnut and glue in place. Re-bed the barrel into the stock. You will need to retain the full-length stock so that you can reshape the stocking swivel and leave the ramrod in its present location. Anneal the hammer and drill out the end in cup shape

possible to accomplish in the making up of these arms.

The reworking of all military arms gives the student better material to work on than he would secure with any factory-made arm constructed to meet the demands of the general public. These are really wonderful materials to work upon. The same is true of the various single-shot actions which are in obsolescence. It has become impossible to secure any ammunition for some of these,

out with new standard barrels, chambered for modern ammunition, you have the basis for a modern rifle.

The Sharps-Borchardt, the Ballard, Winchester S. S., Sharps, Remington-Hepburn, Maynard, Peabody, etc., are all well known and are all good. There are also some German, Swiss, and

British single-shot actions; whenever the student can run across such actions at a reasonable price, it will be well to secure them, this holds good with all the military arms. In this way you will continue to gain experience which will carry you along into an advanced stage of finer gun-making.

CHAPTER XVII

Fitting of Sighting Equipment

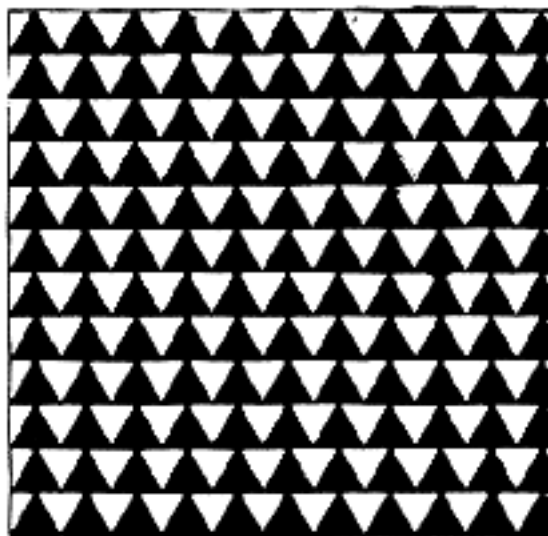

Fitting of Sighting Equipment

SIGHTS are for the purpose of facilitating the most accurate aim on a rifle. The selection of appropriate sighting equipment is, I believe, one of the most discussed topics among the shooting fraternity, for in this almost infinitesimal part of an arm lies the responsibility of true aim. It is also because of this that when marks vary, the shooter is most ready to jump to the conclusion that the error lies entirely with the sights. A trip to the oculist often proves enlightening and will save the student much trouble before he blindly endeavors to put his entire sighting equipment through a metamorphosis; that is, unless the fact that his sights are altogether at fault is very apparent.

When a rifle is equipped with specially made sights rather than the factory standards, two essential points should be taken into consideration: whether the rifle is to be used for target work or game shooting. Sighting and holding for woods or open shooting requires adaptation to the purpose intended and is an entirely different kind of shooting from that done on the rifle range. The latter requires careful aim, the gentle trigger squeeze, then the fired shot, whereas the game shot or woodsman, a man who is accustomed to the open, will not hesitate but fire instantly as soon as the rifle is brought to his shoulder. When we analyze the situation, the woodsman's training must enable him to hit swift-moving game—deer, moose, elk, bear, etc. The target shooter who is a good holder and proud of his record on targets at 100, 600, and 1000 yards will often miss an elk or moose at 100 yards. He is too slow and cannot see the sights plainly against the dim figure of the animal. Likewise, the woodsman will make a disgraceful score at the targets.

There is an endless variety of sights, ranging from the most simple types to those rather complicated in design. They are classified as aperture, open, and telescope sights. Originally there were only two, namely iron and telescope sights. This was sufficient when only speaking in terms of the target shooter, or from the military standpoint; but we must now consider the hunter who uses open sights on fast-moving game. In the past he was given little attention, probably because of his meek

and humble ways, but from now on he is to be recognized, for his experiences in the Northwestern section of the United States have put him in a prominent place.

The standard sighting arrangements on military and factory arms are very poor, but of course these are built for hard service, and therefore are not as fine or as capable of delicate adjustment as certain aperture sights used for target work. For example, the standard sights on foreign military arms are extremely poor compared to the Springfield Model 1903. Still, that sight is no exception. However, one can accomplish a number of combinations on the fixed base, after the movable base has been removed. It only requires the turning of the windage screw until the sight is completely removed from the lateral adjustment and free of the worm. Then the flat base is ready, except for the pivot lug, which must be filed off. Both front and rear projections may be used for any purpose intended or to anchor a new sight.

Telescope Sights—After one has become proficient in the use of aperture or open sights, his one ambition is to own a telescope sight for its superior advantage over either aperture or iron sights. Since the telescope is the means of securing the finest accuracy it is deserving of more attention, particularly at the target and on small game. These facts are well established where the hunting of woodchuck, squirrel, crow, etc., is the pastime of so many outdoor men. On the other hand, hunting telescopes and mounts are rather difficult things to take care of by the average big-game hunter. Where it is next to impossible to do so they are more or less worthless. They have been used successfully on long hard hunting trips, but they are usually discarded afterwards, as a slight fall or jar will put them completely out of adjustment.

There are, of course, various advantages in the use of telescope sights, but when the bounds of practicability are overstepped with these delicate instruments you can blame only yourself. They have been designed and made to stand just so much abuse and no more. The advantages of a telescope sight are that it greatly reduces the errors of aim

and allows objects to be seen more distinctly than with the naked eye. In selecting a telescope two objects are to be kept in mind; either it is to be used for hunting or for target purposes; if the latter, a high power will be practical, but for the former a low power with a clear bright field is desirable.

Open Sights — Open sights are extremely simple in form but are the quickest and most positive for game work that can be made. I refer to the fixed sights set for one range only, the rear top edge filed to form a V or U notch. There are also some without any form of cut-out except for a center line to hold the horizontal position.

If the student aspires to become a game shot and has never faced difficulties encountered in rough localities such as the Northwest, he can gain similar experiences by artificial means or wait for certain weather conditions to present themselves. He must prepare himself for such handicaps as the bright sun shining in his eyes, or the gloom of an approaching storm. Have target objects made by hand in the distance, representing different game with color arrangements similar to that of an animal. Look for objects at the edge of a forest which cause the blurring of sights. You must be able to combat wind storms, the wind being strong enough to blow the muzzle of the rifle from three to twelve feet off its intended mark, and the effects of snow or driving sleet against the face. You must be able to judge distance under all these difficult conditions, remembering that a miss is just a lost shot. It is apparent how useless an aperture sight is under these conditions, where snow or even pine needles may block the passage; or a wind gauge when you are constantly changing position. There will be times when your hands are shaky from physical exertion, and when, to make matters worse, your mark has a protective color and is seldom motionless, hardly two shots being fired at the same range.

If you wish to become a hunter, or if you are one already, experiment with open sights until you find a combination which is perfect for your eyesight. By all means do not allow target work to interfere with what you often dream about—the far-away open country near the mountains. The open sight, like the open country before your eyes, will be your most reliable companion.

Aperture Sights — Aperture or peep sights are the most accurate. They are classified separately and are seen on both target and hunting rifles. The natural aptitude of the eye to center objects enables one to do this with a greater degree of

accuracy when deliberate aim is taken on any object. The advantage of this is the fact that it is possible to establish a perfect point of aim at any given distance and make the most delicate adjustment both for elevation and windage with any standard loading or special hand-loading of ammunition by yourself. On open sights this cannot be done, except by the addition of a number of leaf sights, but then accuracy is destroyed if shooting at greater ranges than 200 yards with the same sight.

It will prove advantageous to have the arrangements for fine adjustments on aperture sights, particularly for the target shooter and for men whose eyesight is not as keen as it might be. Sights which contain an aperture may be used for practically all

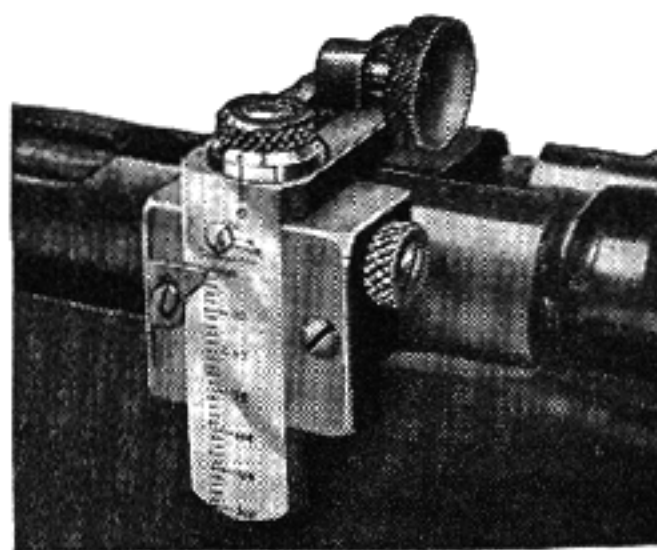

Fig. 112
The famous Lyman 48 aperture
sight for Winchester Model 54
Rifles

purposes. They have become without a doubt the most popular sights for rifles of all descriptions, and for target shooting they stand supreme the world over. They are preferred by the majority of hunters on the North American continent but are not the choice of experienced hunters in other parts of the world. Great credit is due the Lyman principle of design, for these people have gone farther and kept in advance of the needs of the target shooter as well as the hunter. Their sights have become standard equipment on the Springfield sporter and also the M-1 .22-caliber Springfield, and they have made sights in the same class which are adaptable to any other standard target rifles. The British have also kept pace with the advancement of aperture sights and today the Parker-Hale design is one of the most sturdy construction, the foremost requirement for good target work where weight is not important. The new Lyman aperture sight for the Model-52 Winchester has been made on the same principle as those of British construction.

When we sum up the advantages of aperture sights for target or game (provided dangerous game

is not being encountered), it will be seen that they permit an almost unimpeded view of the target or object during aim. For this reason it is easier to align quickly and hold the target longer with a clearer definition of the front-sight adjustment which is necessary on target arms. However, in elevation and windage, it is a detriment in the hunting field, for once an aperture sight is set at a given range for game work, it must be locked in place and left there so that it is impossible for any one to unscrew it; for if the screws rub on parts of the equipment this will throw them out of alignment.

Front Sights — Front sights are divided into three classes: beaded sights, blade sights, and globe sights. Heretofore there were only two kinds, open and globe. This classification did not take into consideration the bead sight of either ivory, gold, silver, etc., and it was rather confusing as to whether a bead or a plain blade sight was designated.

There is such an endless variety of front sights on the market today that it is rather difficult for an amateur to know just what to choose for his purposes. I dare say that in the end he will find it necessary to make one for his particular use.

The most essential point to consider in the construction of a front sight is the correct shape; second comes the clear definition at the tip or top upon the object aimed at. All front sights should be made of alloy steel. Tool steel or spring steel



Fig. 113

Lyman globe target front sight showing the nine interchangeable insertions

is good, but the alloy steels have greater elastic limits and are not as liable to bend or break even tho they are made very thin.

When attaching front sights to a base, they should always be fastened securely by such means as screws, dovetail slots, etc.; once in place, they become permanent fixtures. Whatever adjustments take place should be obtained by the rear sight. An important factor to consider in selecting a front sight is the effect of various lights on certain metals. Silver will cause more or less glimmer in bright light; consequently one so selected will change elevation and windage and the fine definition will be impaired. Gold, when given a dull finish, is the most practical metal to use in a beaded

sight because of its color on an object in strong lights. It also has the advantage of strength. I do not recommend ivory beads because they are apt to be brittle and frail. They are, however, advisable on a hunting arm used for wilderness work. Another more practical substance has been found which will be described later.

It has been found that the flat-top blade sight is the only satisfactory one to use on a target rifle. The width of a front-sight blade must be so that it accommodates the eye on the object, either game or target; I have found that a blade 0.080 inch wide is the best to give the clearest definition. The width of these sights is a matter of choice with the shooter; however, the target shooter will find one much wider to his advantage.

Globe sights have been designed for the purpose of target work only. These have a protective covering in the shape of a cylinder which fits over the center post or aperture. Because of delicate construction, it is possible to have finer posts and apertures than on the open-front sight. Very satisfactory results are obtained with these sights on the rifle range, but still greater improvements are possible and probably some day one will be designed that will meet with greater approval among the target enthusiasts.

Factory Sights — Undoubtedly the job of gunsmithing most frequently attempted by the average rifleman is the alteration or substitution of the sights upon his rifle. In past years nearly all factory arms have been fitted with the cheapest and simplest combination of front and rear sights; but in the last year or so the tide has turned and one can now buy a factory arm fitted with substantial and practical modern sights. However, this question of proper sights is a much varied and discussed matter among sportsmen, and it is seldom indeed that the rifle shooter of experience or advanced ideas is contented with the sighting equipment originally on his rifle. Generally several changes will be made before a satisfactory combination of sights is fitted. Hence, in this chapter I shall dis-

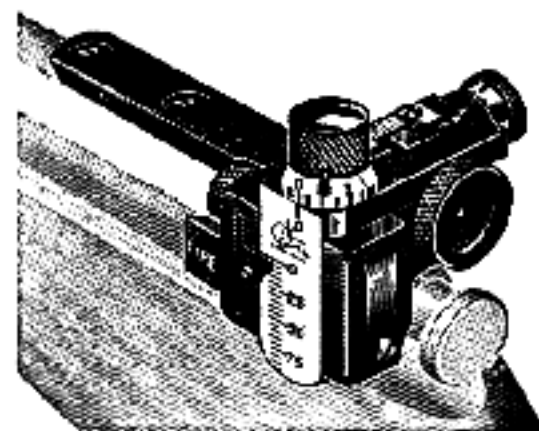

Fig. 114

The Lyman 48 sight adapted to the Model 19 and 23 Savage rifles

cuss what may at first seem elementary and trivial matters to shooters who have traveled any distance down the road called "Sights and Sighting."

The first and most commonly desired job of sight work is the one of removing the factory sights and replacing them with other commercial sights more to the owner's liking and ideas. And fortunately, as most factory sights are merely driven into dovetail slots in the barrel, it is a simple matter to drive them out again; the only danger being the possibility of bending the barrel or springing it, and this we can easily avoid. The novice who thinks this matter of bending the barrel to be over-emphasized, should read up a bit on the methods by which rifle barrels are straightened.

Barrel and Tang Sights—Let us assume that you have a Model-12 Remington .22 rifle fitted with the usual factory sights dovetailed into the barrel, and that you wish to replace these with a Lyman gold-bead front sight; a Marble's folding leaf in place of the present rear sight; and a Lyman No. 2-A combination peep sight to go on the tang. Here is an excellent and most practical combination of modern sights for a .22-caliber hunting rifle.

Obtain the new sights before you touch those now on the rifle, and if you specify correctly you may rest assured the manufacturers will send you ones which will be of a proper height and fit to replace those which are being removed. Occasionally, it might be found advisable to send the old front sight in order to obtain a new one of the same height; should this be necessary, be sure to take a fine scribe and scratch a faint mark on both the old front sight and what you accurately figure to be the center of the top of the barrel; place a mark on the surface of the sight towards the muzzle. This enables you to replace the old sight when it is returned, or to determine the center of the barrel when you come to the fitting of the new sight.

The actual owner of the rifle is about the only person really qualified to sight in that particular gun to suit his own individual peculiarities of eyesight. No factory can guarantee sighting any rifle to shoot to its same "point of impact" for a customer they have never seen. In that excellent work, *Military and Sporting Rifle Shooting*, Captain Crossman has devoted an entire chapter to this important subject of properly sighting a rifle, and I cannot possibly do better than to refer the reader to this book. In the instructions which follow I am assuming that the reader is replacing the sights on a rifle already sighted in to his own style of shooting and eyesight, or one which

has already been proven to be accurately sighted.

When removing or setting in the new sights, the barrel of the rifle must be supported very solidly at a point as close to the sight slots as possible. Clamp the barrel between the felt or lead jaws of the vise and clamp it tightly, letting the butt rest upon the gun brace. Should the work extend from the jaws too much, vibration takes place, and instead of moving the sight from its seat the blows applied may only upset the base of the sight, or the barrel may be sprung. Before knocking out the old sight, tap it very lightly at first to find just how securely it has been set in. Increase the blows just enough to start it loose, then with light taps move the sight on over in the slot until it can be taken out with the fingers. Always save all old sights or other discarded parts from firearms and put them in the "glory box"; one can never tell how handy these old parts may be on some future job.

Barrel sights are always driven into their slot from right to left—the barrel pointing away from you as in the act of firing; hence, old sights are driven out from left to right. The old sights should always be driven out with a short piece of soft copper rod, for there are times when a brass rod will upset and mar the ends of the sights badly, especially when they have been driven in very tightly. A piece of $\frac{1}{4}$ -inch square copper rod is ideal for this purpose. The rear sight comes out in the same manner as the front; only, grip the barrel in the vise jaws as close to the sight as you can—right underneath the slot if possible.

When setting new sights into the dovetail slots they should be driven in with a piece of round hard fiber, for this material will not disfigure the edges of the sights. If the sight goes in too hard, remove and note the bearing surface on the angle of the base. Then with a three-square file having one flat ground smooth, its edges sharp, and with the correctly ground angle to fit the bearing surfaces, carefully file the front edge until it fits the slot. Be careful and try often; do not file away so much metal that the sight goes into the slot too far. Never file out a standard slot if you can avoid it; the next sight you try to fit in such an enlarged opening may be too loose.

Often the reverse conditions will exist, and the new sight is too loose for the slot. If this occurs, a small brass or copper shim under the sight base may correct it. If it is still too loose, you might peen over the edges of the barrel dovetail slightly; but this is unsatisfactory, particularly on old arms, and it is better to send for a specially made wider sight. Or you may have to resort to a gib or "Dutchman"—a wedge filed to an angle on the

sides so that this piece, when made, will be flat on top and bottom with all angles fitting to the sight and slot. The new sight is then driven in against this and should become very tight. This gib is often necessary on the older and more obsolete arms, which had their own sight standards and vary more or less, some of them calling for sights with very broad bases; a gib $\frac{1}{8}$ inch wide or more must be made in order to use our present standard sights.

Occasionally you may receive a new sight with the dovetail base so poorly shaped that it cannot be fitted; the angles do not come out sharp and the edges are a bit rounded. Or the slot in the barrel may prove to have rounded edges. Attention must be given such conditions to see just where the bearings are; hold the barrel up against the light and see that all angles have perfect bearings against each other; otherwise the sight may work loose in time. Use a small three-square file for most of this truing up and shaping of sight bases, a file having one smooth face for safety. The ordinary tapered saw file is not suitable for this work. It pays to have one or two special files made up just for the purpose, and the three-square such as I have mentioned is the best.

When driving in the new sight, do not force it to the exact center of the barrel at first; keep on the safe side until a few sighting shots have been fired for alinement. A range of twenty-five yards is sufficient for this check-up. If the sight has been driven clear to the center mark on the barrel, and if the sighting shots then show it necessary to drive it back again, the slot may have been expanded to such a degree that we have a loose sight.

Getting back to this matter of the Model-12 Remington which we are to fit with three new sights, I may state that I have often changed the entire sighting equipment of such a rifle without the firing of a single sighting shot, and yet had the rifle shoot to the same center of impact as before. When three sights are to be fitted it is really very simple, assuming the rifle has already been correctly sighted. You first fit the peep sight on the tang, checking it for alinement with the two barrel sights already in place. It is surprising to see how many times the mere tightening down of the new sight in the tapped threads is all that is necessary; our sight manufacturers deserve credit for the tolerances they work to. Once secured tightly and found to be at right angles, the new sight can be adjusted for point-blank range; this will be referred to later. Then drive out and replace the rear barrel sight, checking it for alinement with the other two. It may be added here that this arrangement calls for one of the folding type of rear sights, as there is no virtue in having

three sights in use at one time; the only purpose in placing a rear barrel sight on in conjunction with a tang peep is for use as an emergency sight or occasionally to check the alinement of the regular sights. Normally this folding sight is kept down on the barrel. With our folding rear sight correctly fitted and in alinement, it is a simple matter to drive out the old front sight and replace the new one in line with the other two. This method always gives two alined sights with which to check, and while I do not always recommend it, it is entirely practical. Should you wish to replace the two old barrel sights with a tang peep and front sight only, the rear barrel sight is replaced with a slot blank, and in case you use the fitting method I have just outlined, this would be the last of the three sights to be replaced.

Tang Peep Sights—The trend of today among rifle shooters is for the use of the rear peep sight, generally of the Lyman design. All modern factory arms make provision for the application of such sights. The rifle comes with tang drilled and tapped with the proper thread, and these have been filled in with dummy screws, easily removed at a later day when the peep sight is installed. All the

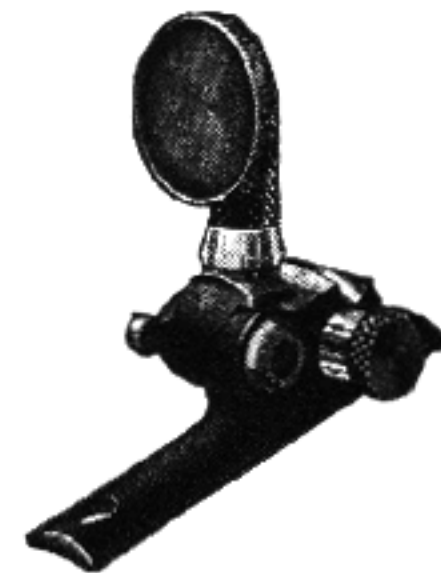

Fig. 115
Lyman 103 micrometer tang sight.
Click adjustments for windage and elevation

commercial makes of tang sights are provided with special screws to fasten them in place on the rifle for which they are specified, even to the long tang screw which on some models is used as a point of fastening. Should you be working on some old relic made before the tang sight was known, it will be necessary to drill and tap suitable holes to take such a sight; this operation will be described later.

To attach the tang sight, first clean off the tang and the under face of the sight base, and check for fit. Select a screw-driver of suitable size and turn in the two screws lightly; then tighten them up together, a turn or so at a time. Sight through

the aperture and make certain it is in alinement with the other sights, after the latter are set at zero. It occasionally happens that when this new tang sight is screwed down tightly it is out of alinement for windage; this is a vital point and one which must be guarded against. Check for this by elevating the stem to its highest point and then sight through the aperture to see if the stem is canted any to right or left. If so, you must file off one side or the other of the base until the aperture is accurately centered over the bore. When filing these bases use Prussian blue, and spot so that a perfect bearing surface will show on the side you are filing; otherwise there may be a rather rounded surface on the base which when screwed in place may cause more or less rock or spring to the sight. It is generally recommended that a strip of thin, hard paper be placed under one side of the base in order to accomplish the desired results, but the filing is a more workmanlike method. Above all, the sight must be set "square" on the tang, so that one can elevate for the longer ranges and not have the aperture run off to one side or the other.

After having everything correct and the sight perfectly square on the tang, tighten it firmly with the screws, and again check for alinement. It will now be necessary to sight in for elevation at the shortest range at which the sight will be used, and to lock the sight so it cannot be screwed below this setting. This is readily done by inserting the small pin which fits into the base of the stem, and filing off the end; the exact arrangement varies with different makes and models. It may require two or three trials before the correct amount is filed off, so go slow with the file when removing metal off the end of pin.

In practise, the fitting and adjustment of these tang sights is a most simple and easy operation. Guard against getting a sight screwed down which is not square and which will therefore change its windage when elevated; and be sure to select and use a screw-driver which fits properly into the screw slots. Nothing looks quite so bad about a tang sight as to tear out the slots on these two screws.

Occasionally the shooter with an experimental turn of mind will desire to fit a tang sight on an old rifle not tapped for such sight bases; or to use a tang sight designed for, and with a base drilled, to fit some other model rifle. This necessitates the drilling and tapping of one or two suitable holes in the upper tang strap—an operation easily done. Use the desired sight base as a templet; aline and scribe it to the proper place; clamp it with suitable clamps; and then drill and tap the screw holes in the manner described further along for the

fitting of a receiver sight or for telescope barrel blocks. The operation is exceedingly simple, as the holes run clear through the tang and are very easy to tap out.

Front Sights — The method of cutting dovetail slots into the barrel proper is an old one and is frowned upon by the present-day rifleman. Today we find modern rifles being made with sight bases milled integral with the barrel; this base is dovetailed, or is slotted lengthwise, and the sight blade held in place by a pin. The Krag and Savage rifles are examples of this latter method, and such blades are easily changed. To remove such a sight, clamp the rifle muzzle in the protected jaws of the vise and drive out the old pin with a small drift. If a real job is desired, throw this old pin in the "glory box," ream out the hole a bit, and tap it for a 2 x 56 machine screw. Countersink or counterbore on one side to accommodate the screw head and file down the latter so it will come flush with the base. Finish neatly, both ends of the screw to be flush with the base, and if necessary deepen the screw slot so that at any future time it may readily be taken out and the sight changed.

The Springfield Model 1903 rifles come equipped with a front sight fitted in a movable stud which goes into a dovetailed base; an excellent design and one easy to replace with no possibility of injuring the barrel. New movable studs are easy to obtain, and there are a number of fine target and hunting sights on the market which readily replace the service blade. Occasionally we pick up a pre-war Springfield with its front-sight stud perched out to one side in order to zero the rifle; this can be remedied by obtaining a new stud, fitting it in the center, and then drilling it by inserting a drill through the screw hole already in the fixed stud. This gives a smooth finish when we look over the sights, and all zeroing can be taken care of by the adjustable zero on the receiver sight with which the rifle is now undoubtedly fitted.

Fitting Front-sight Bases — Now and then we find it necessary to cut off a barrel in order to shorten it, or to repair a damaged muzzle; and this makes it necessary to arrange some provision for the new front sight. Today, the prevailing fashion is a ramp sight, but it is often the best plan to fit some sort of a base similar to the fixed stud on the Springfield, which is really a ramp sight without so much incline to the rear. I shall briefly describe the manner of fitting such a sight.

The parts required for fitting the standard Springfield front sight and base are as follows:

1 stud, movable, assembly
1 stud, fixed

1 pin, front sight
1 sight, front

Any member of the National Rifle Association can purchase these very cheaply from the Director of Civilian Marksmanship; in fact they can be purchased much cheaper than they can possibly be made.

The operation consists of starting the new stud over the end of a large barrel and boring it out to a proper fit. In most instances it will be found best to fit this stud on over the barrel before it is cut down to the new length. Tap it up as far as it will go with a piece of brass, and then peen lightly all over the encircling barrel band with a light hammer until this stretches the band so it can be forced on a little further. Continue alternately to peen and drive on the band until the sight is in its final position; it may be found necessary to strike down the barrel sufficiently to get it back to this final place. When accurately fitted in position, cut down the barrel and crown the muzzle.

This fixed stud may be either sweated or pinned in place, or both. Assemble the barrel and action, and line the sight base up vertically; then faintly scribe the necessary alinement marks. Take off band, and tin both barrel and inside of band; then sweat band back in place. Take a very small round Swiss needle file, insert it through the small hole in rear end of stud, and file off the contour of barrel surface inside this hole. Then drill out hole through stud with drill a size larger, which makes a smooth job, and drive in a pin made from a piece of drill rod. The barrel should be ready to polish for bluing.

Now that the fixed stud is attached in its new position it is an easy matter to fit the movable stud in place. All the various sight companies furnish a variety of bead or target sights to fit this standard Springfield fixed stud, and these may be inserted with no trouble whatever. In case you want to obtain a sighting line as close as possible to the bore, it will pay to obtain the regulation movable stud. Fit it in place and fire the rifle for the required height of front sight, filing off the blade until the lowest practical height is obtained. This filed-down movable stud can be mailed to the sight company with a request to send you the desired sporting sight of a height similar to the sample sent. Or possibly you may wish a blade of extreme height in order to clear telescope blocks.

The skilful workman can readily make up his own front-sight base on the general order of the Springfield fixed stud with no other tools than a hack-saw and files.

inclined and matted plane leading up from the top of barrel to the sight blade or bead, is becoming increasingly popular among our sportsmen. At the present time it is possible to purchase excellent ramp front sights from the various private manufacturers. In Volume II, Chapter XIX, I describe and illustrate twelve different sight ramps which may be made, but in order to make this chapter complete I shall describe briefly the fitting of various sights to the ramp after it is made and the fitting of such commercial ramp sights as may be purchased.

The sweating or brazing of the ramp to the barrel is described in Chapter XXVI, but a brief outline of the method will be given here. The height of the ramp is governed by the sight to be used and the height of the rear sight. After this is estimated and the correct height of the ramp arrived at, the top is filed off, and the ramp drilled and counterbored to take a 5 x 40 or 6 x 48 screw with a fillister head and then marked for position on the barrel, leaving a clearance of about $\frac{3}{8}$ inch from the muzzle. This must be set up square and clamped tightly in place, and the hole is then spotted and drilled in the barrel. Too much care cannot be taken when drilling this hole to avoid going too deeply, and possibly breaking through into the bore. The depth should take but three or four threads of the bottoming tap and the tap drill used must be ground very flat on the end so that all threads are secured to the bottom of the hole. Mark the spindle of the drill press or the drill for correct depth on this operation. After the hole is tapped, the barrel and ramp are each tinned and the ramp again placed in its proper position. Re-heat just enough so the solder is melted, pull the screw up tight and allow the parts to cool.

The slots which are placed in these ramps may be for the standard factory dovetail front sights as illustrated in the Lyman catalog. A lengthwise dovetail slot can be filed in, altho the former will require a vertical milling machine or a small milling attachment. These sights are most satisfactory when the sides of the sight are filed flush with the ramp, and a sight cover made from tubing and fitted into a lengthwise slot filed to receive it, which will make a most complete and pleasing arrangement.

The caterpillar type of front sights as made by Lyman and Marble are most desirable for use in a ramp with the slot milled lengthwise, but are expensive and often troublesome to fit. They come in various heights and it is an easy matter to secure the desired elevation. Often, however, the fitting of these sights is a job for a highly skilled mechanic with suitable milling equipment, and it is generally

Ramp Front Sights — The use of the ramp, or

advisable to send the barrel with ramp fitted in place, together with a dummy sight of the desired height, to the sight maker and have him complete the work properly. All the necessary operations for this will be found in Volume II.

Caterpillar sights, and such others as are fitted into lengthwise slots on the barrel ramps, may be locked in place in a number of ways. The sight base may be made a driving fit and driven into the slot from the rear, and then recoil will tend to keep it from loosening. Or it can be filed off at the base to a sliding fit (one readily interchanged), and then held in position by one of the methods shown in Chapter XX, Volume II. These drawings are sufficient to enable any good mechanic to make either device with no trouble, but I consider the plunger catch illustrated to be the simplest to make and also the most dependable when locked in place. It can be turned from a piece of $\frac{5}{32}$ -inch drill rod. Possibly the simplest locking method would be to tap the ramp for a small screw to fasten the sight.

Rear Sight Bases — Quite often it will be desirable to fit a folding rear sight on a barrel not slotted; and present ideas advise strongly against the cutting of any slots in a barrel. Some riflemen ridicule the idea of any sight in such a place, but there is so much possibility of an accident happening to the rear aperture or receiver sight that in many instances this reserve sight is very advisable. It is particularly useful from time to time as a check to see if the adjustment screws on the peep sight have been moved or tampered with by some curious bystander.

The most satisfactory method of securing a rear sight to the barrel not slotted is by means of a solid base sweated and screwed in position. This is especially applicable to remodeled military arms where it is necessary to carry considerable elevation on the rear sight in order to clear the receiver. Both width and length of the new base may be governed by the new sight intended to be used—whether a series of folding leaves or the usual factory standard.

Figure 116 illustrates a three-leaf folding sight made on a special base bored out of a 2 x 2 inch block of steel; four bases are obtained by this method. But if one is adept with a file it is easy to file one from a square piece of steel about the same width as the desired sight. After the correct contour of the barrel is filed out, the rear and front ends are filed to some artistic shape; the height is then filed down, after which the dovetailed slot may be placed in with a three-square file. A small hole is then bored in each end and counterbored to

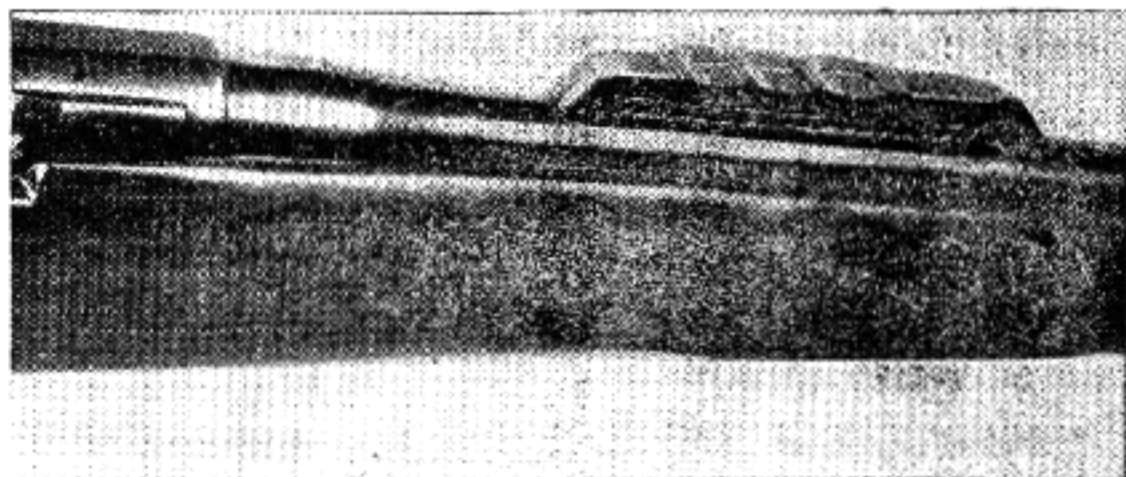

Fig. 116

Illustrating how leaf-sight bases are applied to sporting arms. This is the most practical and artistic method

take the heads of suitable small screws. Polish the base neatly and then square it up in place on the barrel; drill shallow holes for the intended screws and tap them in the same manner and with the same care as advised for a ramp front sight. After this the sight base and barrel are properly tinned and the base screwed into place and heated enough to melt the solder; the screws are now pulled up tightly and the work allowed to cool. A base fitted in this manner will never become loose from vibration.

Another method that I do not care for is to make a band to encircle the barrel, with the sight driven into a slot on top. The proper construction of this sight-base band requires a lathe and milling machine operation, and even when neatly fitted it looks rather out of place. The old Newton rifles had just such an arrangement, but the band was locked in place with a set screw into the bottom of the barrel. The Winchester Model 54 has this sight base integral with the barrel; but this base is placed in rather a low position and looks very well. However, the longer base such as I have described above, when properly fitted and sweated to the barrel, looks much better, even tho you are going to use but a single sight leaf; it appears to add a touch of individuality.

Receiver Sights — The popular sights of the day are the aperture sights which fasten to one side or on top of the action or receiver of the rifle. From an optical standpoint this is not as desirable a position as on the tang of the rifle, as it moves the aperture away from the eye somewhat and defeats the great advantage of a peep sight, which is to have it as close to the eye as possible. However, on a bolt-action rifle and on many of the lever actions it is impossible to place a sight in line with the travel of the bolt when the action is functioned. Hence the "receiver" sight, the best example of which is the well-known Lyman 48 and its many modifications for various types of rifles.

Recent years have seen this Lyman 48 type of sight being widely adapted for use on many types of rifles whose construction and action permits the use of the older tang sight. The receiver sight offers an advantage over the tang sight in that it is more solidly fastened, the aiming aperture being better supported and not having the lost motion of the long sight stem on a tang sight; and the windage adjustments are more accurate and positive.

Practically all these receiver sights are alike in principle and construction; a steel block forms the base, and this base is shaped for practically a finish fit to the action for which it is intended and on which it is permanently screwed. An adjustable elevation slide rises from this base, having a cross arm extending across the action and line of bore;

have a flat surface which can be laid upon parallels; this is the working surface to do all laying-out from. The Springfield, Mauser, Enfield, Krag, Remington 30, and Winchester 54 all have a flat under-surface on their receivers. Single-shot and lever-action rifles must be squared up with the sides of the action by placing the square along this action side and on the surface plate.

Having brought the under side of the sight base to a known contour and both surfaces in direct and full contact, clamp the base to the receiver in approximately the correct position, using either "C" or parallel clamps on the receiver. With a try-square on the surface plate, true up its side surface, shutting out all light from the upright blade of the square. Now test the base for square on the front side, which should be the same as the face. If it

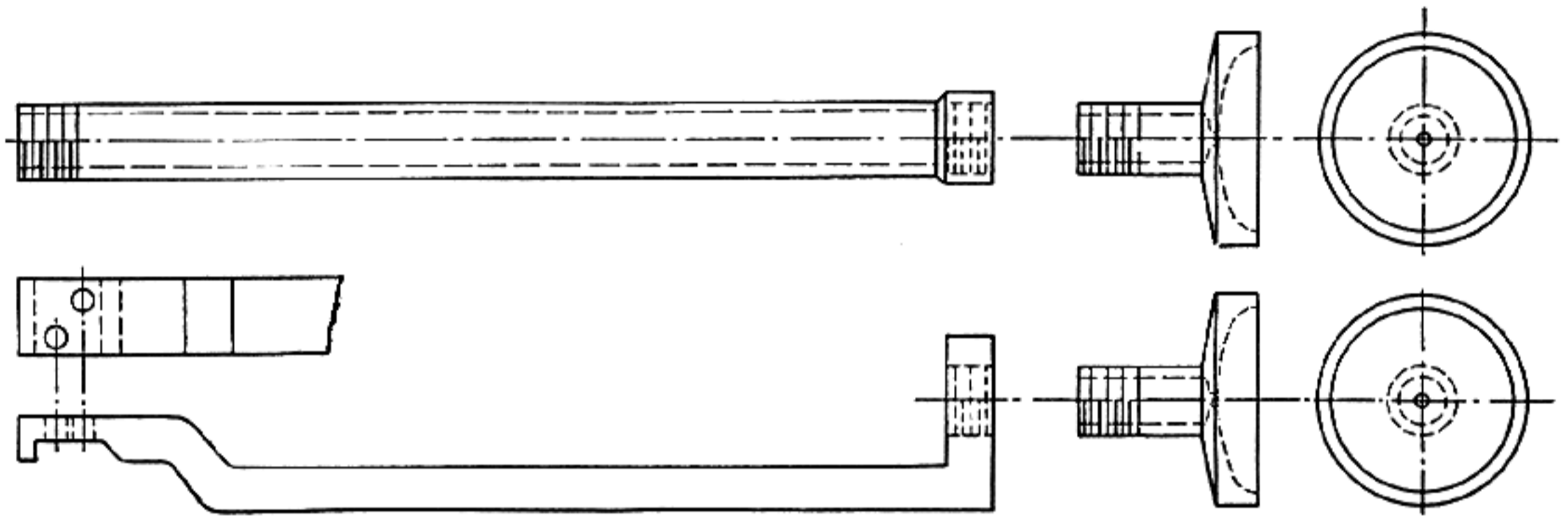

Fig. 117

Special extensions for aperture sights. Used mostly by the target shooter on caliber .22 rifles

this cross arm carries the aiming aperture and has adjustments for lateral travel. The adjustments on both stem and cross arm are accurate and positive, and the general mechanical construction of the sight is excellent, micrometer movements being possible for either elevation or windage.

The Lyman 48 sight is best known for its almost universal use on the Springfield rifle, and a description of the correct method of attaching it to the receiver of this arm will answer for the others. Invariably the sight fits properly over the contour of the receiver, and it is seldom necessary to do any further fitting here. Still, it is well to test this bearing with the elevation slide up to its full height and note if there is any leaning of the aperture to right or left; if so, it will be in order to do some spotting and work off the necessary surfaces from the face of the sight base.

The sight having been found to fit snugly and properly to the receiver, there remains the set-up for drilling. It is necessary to strip the rifle from its stock and take out the bolt. Nearly all receivers

is square from both positions, tighten the clamp, and then recheck to see that the base was not moved during the clamping operation. A base "square" in this manner is suitable for a hunting rifle where the sight is seldom elevated to extreme ranges, but is mainly used for slight changes to adapt it for various lots of ammunition or different velocity cartridges.

Should you desire to use the rifle for long-range target work in match shooting with service ammunition, it will be necessary to set the sight slightly out of "square," or leaning to the left in order to take care of the "horizontal deviation" or "drift" of the bullet. However, I doubt if many owners of sporting Springfields will go to this trouble, as the regulations in most of our national matches require the use of the service Springfield "as issued." Should it be necessary that you fit a Lyman 48 sight to offset the effects of "drift" at the bullet's most important ranges, you must carry the sight base on a slight angle to the left. To secure this correct angle, get a Springfield drift

slide and clamp it squarely to an angle plate; then with a bevel protractor take the exact angle of the side of this drift slide. With the protractor set to this same angle, set your sight base accordingly and clamp it firmly in place. The sight will not look very well when slightly at this angle to the left, but it is entirely practical and appearances do not count on a target arm where the scores obtained are the main object.

Have the sight base in its absolutely correct position and clamped tightly with the parallel or "C" clamp so situated that the drill chuck will not hit in on its downward travel, or allow any chance of a slip or other misadjustment.

Whenever setting a sight or base on a receiver or barrel, it will be well to scratch a line on both ends or the corners, to verify the set-up for location; then it will always be possible to tell if the piece has moved at any time. At this stage of the operation the holes are ready to spot, drill, and tap.

Drilling and Tapping for Sight Bases — Nearly all sights and bases have two screw holes, by means of which they are fastened to the barrel or receiver with two finely threaded screws. The exact centering of these screws through the screw holes is important, and in order to do this it is best to begin by selecting a drill which will just pass through the clearance holes in the sight base. With this large drill the exact center of the hole is "spotted," after which we follow on through with the proper-sized or "tap" drill. Having the receiver or rifle on parallels or V-blocks, place it on the drill-press table and first use the spotting drill. Care must be observed to secure a center in the metal with this drill sufficient only to enable the proper tap drill to follow; a common error is to allow this large spotting drill to pass through by not remembering to change it after the center is secured. If you do not happen to have a drill press available for this operation and must use a breast drill, place the rifle in a vise between felt or lead jaws and proceed in that manner. By drilling the holes according to this method the sight or base acts as a drill jig.

Having spotted and drilled the holes as outlined above, and being certain the clamps or base have not moved throughout the various stages of the operation, complete the tapping of the holes with the sight or base still in position. By this means, the clearance holes act as a guide to square the tap, enabling the screws to be pulled up square and even against the base.

A rather common error is that of removing the sight or base after spotting the holes, then using

the tap drill and not securing the same set-up. The hole is seldom tapped square, and the operation usually ends with the base out of square, which strips the screws in their holes. If this should happen, use the next larger size screw; but this time square the hole and use the correct tap drill for the intended screw.

After the tap drill has been put through the hole, use the bottoming tap, tapping down to within $\frac{1}{16}$ inch through the receiver. Tap the holes with the base still in position as outlined before, as this will allow the screws to be pulled down perfectly even and tight. After the holes are tapped, remove the base and drill the $\frac{1}{16}$ -inch web out of the base so the screws will be free.

Whenever drilling with the tap drill, after having the surface spotted with the body drill, care must be taken to keep the drill alined in the center of the hole in the base. The exact depth to which you drill will depend upon the thickness of the parts you are drilling into. Always measure for the depth intended, and then mark it on the spindle of the drill press or on the drill shank; come down to this mark and no further. Naturally you must drill deep enough to secure sufficient threads for strength to hold the parts securely in position. Bottoming drills must be used and also bottoming taps to secure full threads to the bottom of the holes. Taps come in sets of three: starting taps, regular taps, and bottoming taps; or No. 1, No. 2, and No. 3 taps. When shallow holes are to be tapped it is usually best to start with the regular or No. 2 tap, and complete the job with the bottoming or No. 3 tap, thereby getting the threads cut squarely to the bottom.

With all this finished, the sight base may be screwed down into place. First, coat the screw threads with sperm oil. Further advice is to use a screw-driver of the correct width in order to avoid marring the slots in the screw heads.

Drilling Hardened Receiver — Practically all the receivers of commercial manufacture and on recent Springfield rifles can be drilled by using a high-speed drill, as the surfaces are not hardened as deeply as they were a few years ago. Many of the older Springfield receivers were so hard that it was impossible to make an impression on their surface with a drill of any kind, and it may happen that you have one of these on which a receiver sight is to be fitted. The Krag also had an action and receiver on which a drill would have no effect. When the receiver is as hard as this, the location where the holes are to be drilled must be annealed properly by heating in order to draw the hardness from around this one spot. This requires a bit of

care and caution, otherwise you may overstep matters and anneal parts of the action which require the correct heat treatment.

First locate the exact position where the annealing is to take place; this is readily done by holding the sight base in its proper location and scribing through the screw holes on the action. Polish this spot between the two holes with fine emery cloth to remove all bluing, and leave bright the location where the screws are to be placed. Moistened clay or wet asbestos may then be worked around this elongated opening, and might as well be placed about the opposite parts in order to prevent annealing the cams, etc.

To anneal, use an acetylene torch, gas burner or blow torch. With the torch, direct the flame into the opening and closely watch the color of the steel as it changes with the different degrees of heat: light straw, straw, purple, blue, dark blue, and finally a grayish appearance. At this stage the flame is turned off and the receiver allowed to cool. This treatment will properly anneal a receiver, making it possible to drill and tap with freedom; and the surrounding metal will not be injured in the least. One may now continue to set the base in place and proceed as outlined before.

If you should encounter difficulty in drilling a receiver, stop and apply the above method for the purpose of tapping the holes. There are various methods which may be employed to force a drill through toughened metal, but we must keep in mind that a piece of metal can often be drilled when it cannot be tapped. It usually happens that our tap breaks in the hole or is broken coming out, because most of the cutting edges are stripped off the teeth.

The annealing of a receiver at the place where most receiver sights are located does not harm the action. The early Springfield receivers were much too hard, and if one of these is encountered—on which a file cannot touch the surface—it is well to ship it back to the Arsenal where they can draw the temper to a point where a greater safety factor is possible. This old idea of an action being glass-hard was a set rule for the first Springfield, but they gradually came to a point where they learned that this was not required. Accordingly, in those early days the advice given was to anneal only the exact spots where the screws were to be placed. Today this may safely be disregarded and you can anneal a liberal spot between these two screw holes when you cannot get the drill to cut with freedom. On a hard receiver it is possible, after a few trials, to force a drill through; but remember that these holes must also be tapped and no tap will stand up through the operation of threading the hole.

The principles I have just outlined for fitting a

48 type of sight to the Springfield action will suffice for any other model rifle for which a modification of this sight is manufactured. On some rifles the receiver or action is not hardened, and the fitting to these is quite simple. If it is an odd model, it will be necessary to follow the manufacturer's instructions, which always come with each sight. On some of the earlier sights, such as the Lyman 33, 34, etc., it is necessary to drill one of the screw holes at a slight angle in order to have the screw fit tight. By using the base as a templet and keeping the drill and taps well centered through the screw holes it is easy to get this angle correctly.

When you have the sight properly fitted and screwed on the receiver, it will be necessary to notch out the stock in order to accommodate the sight base properly. Read over the instructions relative to this in Chapter X (Modeling and Final Shaping), as it is important not to have this notch fit so closely that recoil will work the base loose.

Cocking-Piece Sights—We now come to the cocking-piece sights, a type which reached the height of its popularity a few years ago, but which has since declined somewhat in the eyes of the rifleman. The advantages claimed for the sight mounted on the end of the cocking piece are: longer sight radius, aperture closer to the eye, simplicity of mounting, and non-interference with the shooting hand when aiming—a fault we sometimes find in a sight mounted on the tang. Also, a sight so mounted harmonizes very well with the outlines of the hunting rifle. But such a mounting also has serious disadvantages and its use is dying out. For one thing, it is a source of danger from recoil on a short-stocked or heavily recoiling rifle, particularly to the person who wears glasses. In firing from the prone position the sight may be driven back into the eye or forehead. Then the added weight of the sight seriously affects lock time and consequently ignition of the cartridge. And finally there is an odd feeling when the firing pin falls which affects the calling of the shot; one instinctively attempts to center his bead again in the aperture as it jumps forward, and this is especially pronounced in the case of the skilled shot.

However, there are men who simply must try one of these sights, and for the benefit of such we will tell about the fitting of them. A model without any windage adjustment is greatly to be preferred; the adjustable models carry too much weight for the cocking piece, and because of the fine mechanism and fitting it is difficult to keep tight the conventional dovetail arrangement which moves the adjustment for windage. Better have the lightest weight and be content with elevation alone.

To fit a cocking-piece sight to the Springfield or Krag it is necessary to anneal the end of knob and mill a dovetail slot through its center. If you have a milling machine available to cut the slot it is an easy matter to get it perfectly square by holding it in the vise 90 degrees or horizontal on the lug. The rounded part must first be faced off before this dovetail is cut, and then the base of the sight will bear against a perfectly flat surface. The qualified operator of a milling machine will have no trouble in accomplishing these operations.

This slot may be filed out if care is used; but it is usually wise to dismount the bolt and mail the cocking piece to the sight manufacturer, who is fully equipped to dovetail the knob and at the same time mount the sight properly. But you may wish to attempt the mounting of the sight yourself, in which case you must first anneal the knob. Wrap wet rags around the body of the cocking piece and expose the end to the flame of an acetylene torch or blow torch until a very dull red appears, and then allow it to cool gradually. Before you attempt to file the slot, the face must first be filed off to eliminate the rounded end. Square this off properly and then coat the face with coppering solution. Clamp the lug in a small bench vise or against the face of an angle plate. With a surface or height gauge working from a surface plate, lay out the slot on the face to the smallest width of the angle. A small, square file is used first to rough out the center to the proper depth, or a hack-saw may be first used, which will remove even more metal, and the file will not have so much to do. Then with a three-square needle file having one face ground off to a flat, proceed to file out the angles. Try the sight often to see that the case fits evenly on the angles and does not lean to either right or left; however, if you file straight with the layout lines this should not happen. When completed, the sight should have a tight driving fit. In driving the sight base

into the slot it must be clamped very close to the vise jaws and be held solidly between lead or felt; in this instance it is much better to use the lead jaws.

Figure 118 illustrates a cocking-piece sight with windage adjustments mounted on a strap and screwed on the bolt sleeve of a Springfield rifle. The end of the cocking piece was first cut off and a $\frac{1}{16}$ -inch pin placed through it, the ends riveted over so that it was impossible to turn out at any time, and there welded. With such an arrangement, the sight never moves, but is held in a fixed position. This is one of the most practical methods of mounting, for it takes the weight off the cocking piece and the removal of the knob increases lock time. After the strap was screwed into position a hole was drilled at a point where the largest amount of metal was, and a $\frac{5}{32}$ -inch ball bearing inserted having a small heavy spring in back of it to take up any lost motion in the bolt and sleeve. A $\frac{9}{64}$ -inch hole was first drilled, and then from the top a No. 19 drill was used with the cutting edge stoned round to approximate the shape of the ball. This was used until only a small web remained at the bottom of the hole and at the same time allowed the ball to project out some distance. The top section of the hole was tapped with a 10 x 32 tap and a small slotted screw fitted. A heavy spring was placed between the ball and screw and the correct amount of tension applied by adjustment of this screw. Such an arrangement eliminates all play whatever, and should become a standard fitting when a cocking-piece sight is set on the end of a firing pin. (See Figure 100, Volume II.)

Special nuts are required when cocking-piece sights are mounted on Mauser, Mannlicher-Schœnauer, and Mannlicher-Hænel rifles. These nuts are placed on the end of the cocking piece with two small screws; and this, incidentally, is not the most satisfactory method to use. If it is at all possible

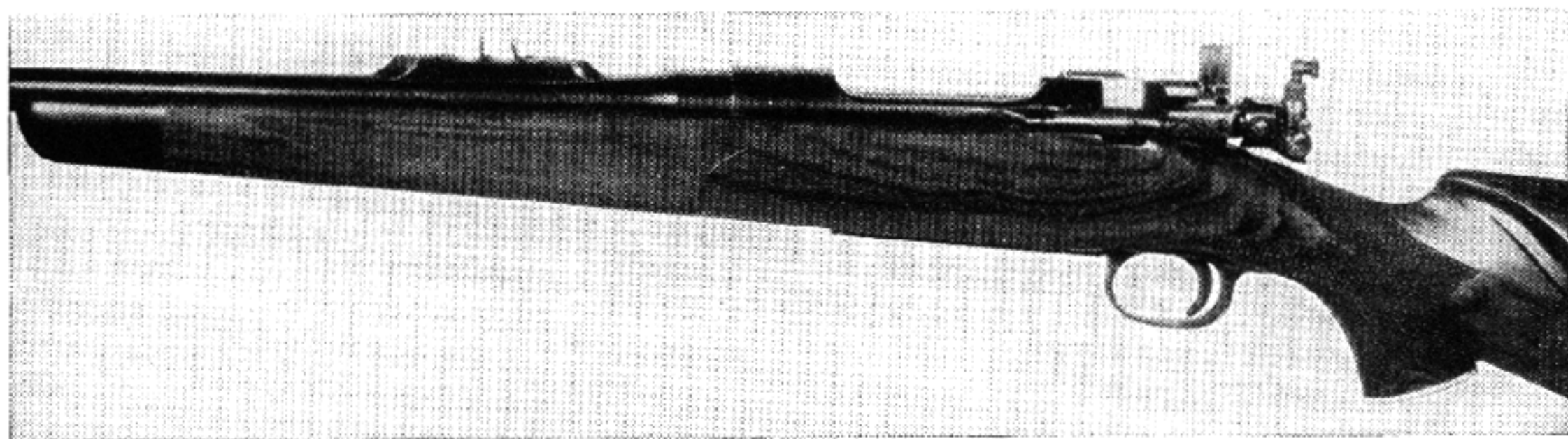

Fig. 118

Lyman 103 sight mounted on the end of a Springfield 30-03 bolt sleeve. The end of the cocking piece was cut off and welded. Strap was screwed to sleeve and held in position by four screws. Rifle designed for Mr. L. S. Canfield for African hunting

to braze these nuts in position it should be done.

When mounting a cocking-piece sight to a Mauser rifle, I first make a special nut, braze it in place, and then mill the dovetail slot for the sight. This is solid and a part of the cocking piece itself and will never come loose, as often happens when these are only screwed in place.

The Mannlicher-Schœnauer cocking piece must be bored out before the standard nut is used. In boring this, make a good driving fit and line up the sight at right angles. This is accomplished by driving in the sight half-way and then checking for the vertical position. If it is not just in line, remove the sight and turn the nut to the correct position. Drill and tap, and place the screws in position; then drive the sight to center of nut. A nut thus placed on the end of the firing pin will always stay in position, but if a loose fit is made in the boring operation, the recoil soon shoots it loose.

I have seen various home-made cocking-piece sights, and some were very good in effectiveness and in the simple manner in which they were set in place. One which I remember very well was stem-threaded with an eye on one end similar to the aperture on a cocking-piece sight. The cocking piece was drilled and tapped and this screwed in place just behind the knob. It required some effort to turn it, as the stem was made to screw in very tightly. An arrangement of this nature is often very simple to make, and when once set correctly for the necessary range will probably prove all that is required. The more simple a sight is made, and the fewer parts it has, the less liable it is to come out of adjustment. I have also noticed a number of different ideas worked out and applied to the sleeve of the Krag rifle, being fastened by one or two screws. On one Krag in particular, the owner had fastened a Newton rear aperture to the sleeve in a most novel manner. Of course, most of these sights had no means of adjustment, but then this was not required in many of them.

After having fitted the desired sight to the cocking piece to your satisfaction, it may be discovered that the gun misfires, "percussion" having been affected by the weight added to the firing pin. This calls for faster lock time; probably a stronger and heavier main spring will be needed.

Enlarging Aperture — There are certain small changes and improvements to peep sights which the shooter may find it advantageous to make, and which I have not touched upon. One of these is to enlarge the aperture in a peep-sight disc. The existing hole may be too small in diameter, and it will greatly improve your shooting to open it a trifle. This is done with a small broach or reamer

such as used by watchmakers; it may be purchased from the sight manufacturers or from dealers in jeweler supplies. Such broaches are tapered slightly, and should be used from the front side of the disc, which retains a sharp edge to the aiming side of the aperture and does away with any reflection while aiming. Enlarge the aperture a little at a time, and if the broach should leave a burr around the edge, this can easily be removed by the use of a small, three-cornered scraper. After the correct-sized aperture is obtained, the disc should be heated in the flame of a Bunsen burner or alcohol lamp until the bright glitter of the metal is replaced by the dark blue of oxidation.

Loose Sight Screws — There are actually but two legitimate complaints against the modern receiver sight: First, "somebody" moved the adjustment screws "to see how it worked"; and second, the screws work loose and permit the sight base to slip and often to drop off and become lost before this is noticed. The former complaint we shall have to leave to the mercies of the fool-killer for action and correction, but the latter is a complaint generally due to ignorance or poor workmanship on the part of the individual who fitted the sight.

A loose receiver sight is invariably due either to crude and worthless tapping of the screw threads, or to the use of the wrong taps in tapping out these threads. In the first case, the threads are generally found to be "tapered out" at the top or torn away through the improper backing-out or breaking of the tap; all caused by the fact that the receiver was not sufficiently annealed to start with, and could not be properly tapped out by any one. In the second case, we generally find that a tap has been used with a type of thread or pitch entirely different from the manufacturer's standards.

The screws supplied by the manufacturers for attaching receiver sights and telescope blocks generally have finer threads than the standard machine screws—and threads that are different; these screws and the special taps as supplied by that manufacturer are the only ones which should be used in attaching his particular make of sight. In case you break these taps, better get new ones from the same source of supply, and not attempt to use the nearest size of standard tap. At best, only a few threads can be tapped out to hold, and these few threads should be tapped in a clean manner, with the sight base clamped in place and acting as a jig to prevent the lost space between the drills or taps; then you will obtain a clean, parallel hole with threads which will grip from top to bottom.

It may happen that the taps or screws furnished by the manufacturer have become lost, and lack of

time or facilities prevents the obtaining of duplicates. In this event it will be necessary to drill and tap for one of the regular commercial sizes which will fit through the screw hole in the base. Following is a table of standard threads and sizes of tap drills from which a selection may be easily made.

Size of Tap	Diameter of Tap	Number of Threads	Size of Tap Drills
2	0.086	48	48
2	0.086	56	48
2	0.086	64	49
3	0.099	40	47
3	0.099	48	46
3	0.099	56	45
4	0.112	32	42
4	0.112	36	41
4	0.112	40	42
5	0.125	30	38
5	0.125	32	37
5	0.125	36	36
5	0.125	40	36
6	0.138	30	33
6	0.138	32	33
6	0.138	36	32
6	0.138	40	31
6	0.138	48	31
7	0.151	28	30
7	0.151	30	30
7	0.151	32	30
7	0.151	36	30
8	0.164	30	28
8	0.164	32	29
8	0.164	36	29
9	0.177	24	27
9	0.177	28	27
9	0.177	30	26
9	0.177	32	24
10	0.190	24	23
10	0.190	28	22
10	0.190	30	21
10	0.190	32	21
11	0.203	24	19
11	0.203	28	19
11	0.203	30	18
12	0.216	20	18
12	0.216	22	18
12	0.216	24	18
13	0.228	20	17
13	0.228	24	15
14	0.242	20	11
14	0.242	22	11
14	0.242	24	10
15	0.255	18	7
15	0.255	20	7
15	0.255	24	6
16	0.268	16	2

There are various other sizes and types of thread used in gun-sight screws, so when measuring a screw always secure the correct pitch diameter. However, the foregoing table will enable you to secure a thread and drill very near to size. When in doubt, first drill and tap a scrap piece of metal and see if the intended screw fits correctly, before you drill and tap the receiver. If a mistake occurs, do not try to fit a screw which has a very coarse pitch, for it will work loose from the recoil on even a .22-caliber rifle. Standard fractional-size taps are

also used in gun work, and they range from $\frac{1}{16}$ to $\frac{1}{4}$ inch in sixty-fourths.

Fitting Telescope Base Blocks — The fitting of telescope blocks to a rifle barrel is becoming an increasingly common operation and one which can well be undertaken by the amateur rather than sending the rifle to a gunsmith or factory which may be many days distant. It is an operation which may be either difficult or relatively simple, depending upon the tools available and the type of barrel on which the blocks are to be mounted.

With an octagon barrel of heavy weight or of .22 caliber it is not a difficult job accurately to locate and center the two blocks to the flat top, and there is little danger of drilling through into the bore or chamber. I have seen such jobs done very neatly without even taking the barrel from the stock or fore-end. But when a round barrel of light weight or with much taper is to be fitted up, the operation and results are liable to be quite different. In general, the faults commonly made when fitting a pair of blocks to a round barrel are to place them off to one side of the sighting plane, or not to have the blocks in proper alinement with each other. Also, the average first attempt or so generally results in holes not in alinement, with a block pointing off to the side; and the screw holes very loose at the top, a fault due to the use of a hand or breast drill in drilling.

However, with the proper tools a very neat and substantial job is easy to obtain, and the operation will be made very simple and easy if you possess a drill jig such as illustrated in Figure 119. With such a jig it is possible to do the entire job by hand, even using a hand or breast drill, and yet drill holes which are clean-cut, perfectly in line, and absolutely centered on the top of the barrel. In fact, if you expect to fit scope blocks to more than one barrel I would advise making or purchasing such a jig by all means.

Assuming that you have such a jig available, all that is necessary is to place this jig in position on the top of the barrel and line it up with your eye. First, insert a full-sized (No. 31) drill in one of the holes, and using this as a gauge, square the jig and center it accurately on top of the barrel; the regular sights may be used to assist in finding the true center during this operation. Or you can find the true center by means of the square and calipers; mark a center line along the barrel top, and then aline the jig to this by means of the center marks on each end. After centering, clamp the jig fast with the two C-clamps, and proceed with the drilling. A hand drill can be used with ease and yet the holes will be true and parallel, not reamed out

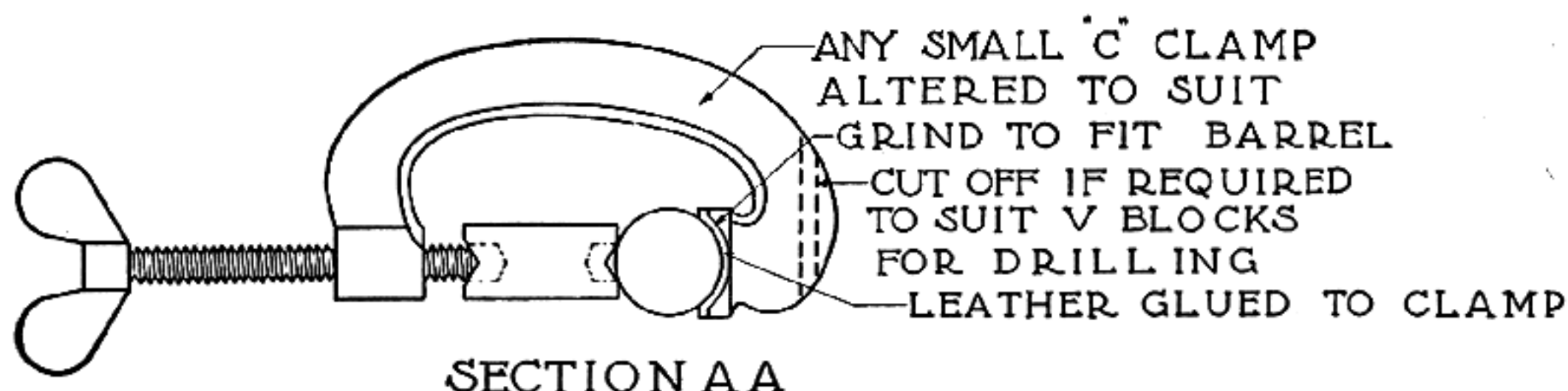
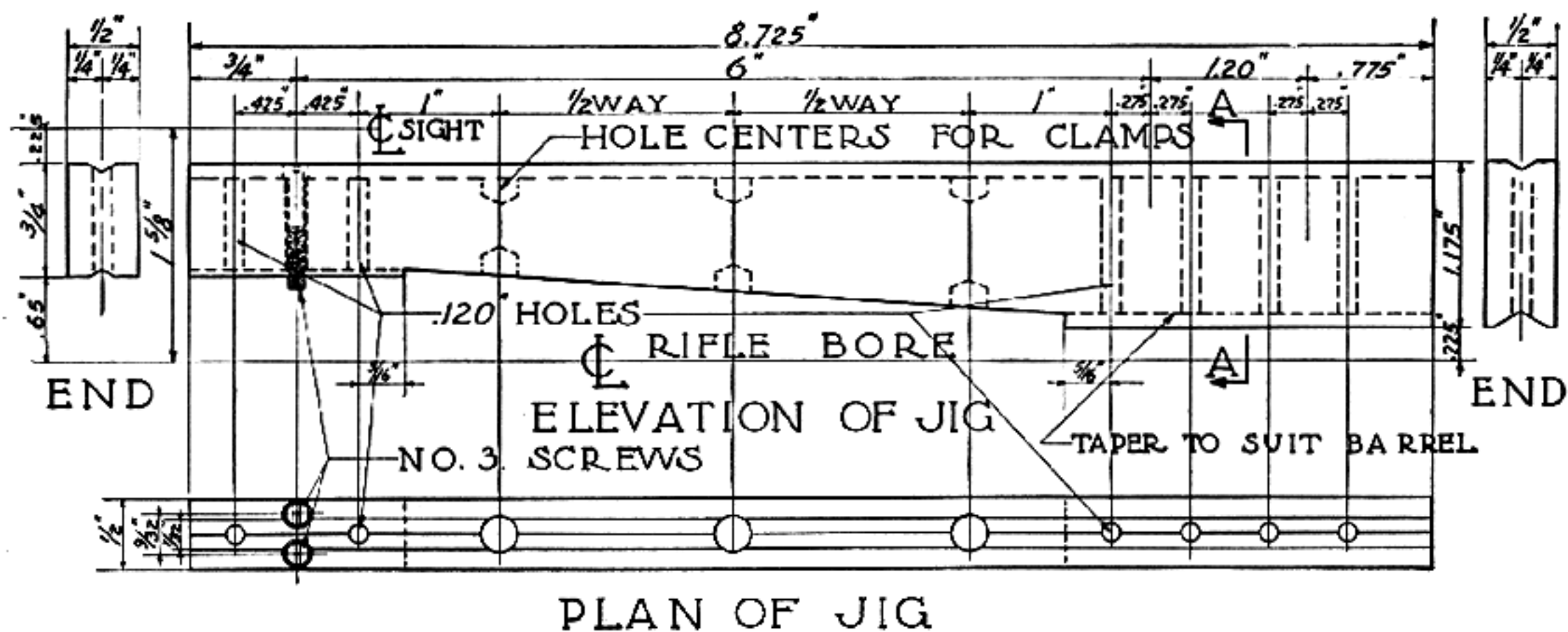

Fig. 119
Drilling jig for placing telescope blocks on rifle barrels

at the top by the eccentric motion of the drill, as is always the case when attempting to use it or a breast drill without any jig or drilling set-up.

When drilling into the barrel extreme care must be taken not to go too deeply; a stop-mark should be made on the drill shank and care be taken not to go past it. Better test with a depth gauge occasionally. You may find it necessary to fit the rear block over top of the chamber; in which event remember that in the case of a tapered or bottlenecked cartridge, the barrel thickness over chamber may be less than that further out over the bore. Always check carefully as to barrel thickness by using a keyhole caliper at the muzzle, and then do not drill down too close to the minimum thickness. I know of one case where a party drilled so close to the bore that he broke through the "web" when tapping the threads. A depth sufficient to catch three or four full threads is enough; should there be any cause for worry as to the blocks not being held sufficiently tight, they can be sweated on in addition to the screws.

I cannot emphasize too greatly the need of a drill jig for the amateur—and gunsmith as well—who expects to fit any of his rifles with telescope blocks. There is no more trying operation for the novice

than this fitting of barrel blocks for the first time; but with a jig of this nature the entire operation is simple and may be performed with only the jig, taps and drills, and a common breast or hand drill. The jig illustrated in Figure 119 is fitted for drilling holes spaced 6, 7.2, and 8.2 inches apart, these being the distances invariably in use on the target rifles today. The flat side of this jig is for use with either an octagon or round barrel having little or no taper, while the opposite side is intended for use in the case of a round barrel with an extreme taper such as the Springfield, the two leveling screws being helpful at times in obtaining a square set-up. The making of such a jig is easy, provided you have access to a shaper or milling machine, or it can be purchased. With this tool the amateur can readily attain a considerable degree of perfection and at the same time is enabled to mount his blocks with the rifle assembled and in its stock.

If you do not happen to have a drill jig to locate the holes correctly in the barrel, it is necessary to undertake the rather extensive set-up or laying out method. First strip the barrel and receiver from its stock. Two squares and a surface plate are needed in order to aline the sights; if you do not have a surface plate, provide some long, true sur-

face in its place, such as a large piece of heavy window glass or a large planed board. Place the barrel and receiver on this, the barrel resting in V-blocks. It is first necessary to get the barrel and receiver at a perfect right angle to the plate, and in the case of most receivers which have a flat under-surface, one V-block may be dispensed with and parallels used. Two squares are used; one with its heavy end resting on the receiver flat and the thin blade pointing down, while the second square is resting upon the surface plate. The barrel is then rotated until the two thin blades of the squares block out all light, which shows that both barrel and action are now in a vertical position.

Having once placed the barrel and receiver at right angles with the surface plate, this position must be absolutely maintained throughout the operation or until the telescope block is securely fastened with a parallel clamp in its correct position. This is readily done by clamping the barrel to the V-block. Clamps are furnished with each set of commercial V-blocks. This is shown in Volume II.

Now clamp the rear telescope block at its approximate location, using a parallel clamp; this clamp is not screwed very tightly at first. Place your small square on the top of the block, and have your second square on the surface plate to come up and meet the blade until all light is shut out. When placed thus, the rear block or base will be in absolute line and at right angles. A further check on the receiver is now in order, to see that it has not moved while all this clamping and testing is being done; then if everything is all right you can tighten up on the parallel clamp and proceed with the locating and clamping of the front block.

The front telescope block is now fitted in this same manner, after the proper distance is secured between centers. These bases are generally set 7.2 inches apart, as this distance permits adjustments which give a movement of $\frac{1}{2}$ inch per hundred yards for each graduation on the telescope mounts. Another spacing between blocks is 6 inches apart, this being all the distance one can obtain with the Lyman telescope on the Springfield rifle and yet have both blocks mounted on the barrel where they belong. The 6-inch spacing gives a coarser adjustment of shots—about 0.6 inch per hundred yards for each graduation. Another common spacing is the 8 or 8.2 inch centers which are used to give greater support or to accommodate construction of some of the larger and heavier glasses, and the differences in movement of the telescope can be figured out by actual shooting on the range; it should be about 0.4 inch.

This question of distance between mounts, and

particularly the exact locating of those mounts on the barrel, are matters the shooter must solve for himself. It depends upon a number of things: the exact make and model of the telescope; its power and eye relief; the position the gun will be fired from; and whether or not the glass is to be left on the gun or will be taken off at intervals and the iron sights used in its place. The eye relief is the main consideration. The more rabid target cranks often have three blocks on their barrels to obtain full eye relief, and then use the telescope in one location for the standing position and another location for sitting or prone. I shall not dwell on this matter of location of the blocks, but can do no better than to refer the reader to Captain Crossman's recent volume, *The Book of the Springfield*, where there are three very complete chapters on the various types of telescopes, their proper location and all about them.

There is one point I shall stress, however; I am a firm believer in placing both telescope blocks on the barrel of the rifle. In my opinion the receiver or action ring of a rifle is no place for one of these blocks; the receiver ring of the Springfield and similar rifles, especially, is not the place where the drilling and tapping of screw holes should be countenanced.

In a previous paragraph I mentioned leaving the telescope on the gun at all times. I find a growing number of rifle shooters in this category, men who do all their shooting with the telescope and who, once their glass is set, never touch the adjustments or mounting of the instrument under any circumstances other than to keep the gun shooting "to center." Despite all the good things told about telescope mounts, there are many of them which cannot be taken off the blocks and returned to place without again sighting in the rifle. There is a small item of consideration here which may help many of these shooters, and that is to locate their rear barrel mount about 2 inches ahead of the receiver and not up against the receiver, as is the usual method; provided, of course, that eye relief and length of tube permit such a mounting. The advantage of such position is that when cleaning the bore or action of the gun, the eyepiece of the telescope can readily be shoved forward over the barrel, where it will not be in the way of the operation and where the eye lens will not become coated with oil or be scratched by some cleaning fixture.

Having both telescope blocks accurately fitted and centered on the barrel, with the parallel clamps very tight, we are now ready to proceed with the drilling of the screw holes. Too much care cannot be taken in this operation; drill only to the correct depth and no more. And do this drilling with a

drill press; never attempt it with a hand or breast drill, as the circular movement or eccentric motion of the handle of these tools will result in a tapered hole; the holes will also invariably run off center. Do this operation on a drill press where the drill attains a good rate of speed, and mark the spindle so that the correct depth will not be passed. First, "spot" the centers of each hole with a drill just large enough to pass through the screw holes in the blocks (this takes a No. 27 or No. 28 drill); then finish with the correct-size tap drill, which is invariably the No. 31 drill for standard-size blocks as now furnished. On a thin-walled or very light barrel it will probably be best to drill a little short of the final depth and then "bottom" or square-out the hole with an end-mill or bottoming drill; the latter is made by grinding a No. 31 drill flat, as described in Chapter IV.

The holes being properly drilled, now comes the tapping. *Be very careful here.* If you have not previously done much tapping of threads, better leave the barrel blocks clamped tightly in position and tap the threads through the screw holes, with the blocks to assist in keeping the taps square during the operation. Use the taps furnished by the manufacturers to suit the screw threads they recommend; there should be two of them—starting and bottoming taps—alho some manufacturers furnish three taps. The starting tap as furnished will possibly have so much taper that it touches the bottom of the shallow holes in the barrel, and it may be necessary to grind off some of its point or use a regular tap for the first operation. In case you are obliged to make your own bottoming tap, this is readily done by grinding most of the taper off a regular tap.

Take the barrel and receiver off the surface plate and clamp them in the felt jaws of the vise with barrel perfectly level and block tops at a right angle; then keep your taps square and you will obtain true and clean threads. Do not try to force any of the taps. Commence with the starting tap and if possible obtain one or two complete threads with it; turn it forward a little at a time and then back it up and advance it a fraction with each movement. Be careful that you do not reach bottom before you realize it and break the tap. This is possible with a long tapered tap. When you are about to the bottom of the hole with this starting tap change to the bottoming tap and work the threads deeper, a little at a time, until the point of tap touches the bottom of hole. Care must be taken not to break the tap as the bottom is reached. Should a tap break, an unpleasant job is ahead, and you will be fortunate to back out the fragments without marring the barrel or tearing out threads.

Read the instructions in Chapter IV on removing broken taps.

All four holes have been successfully tapped, the barrel clamps are now removed, and the blocks are ready to be screwed down tight. First examine the holes; there will probably be a slight burr raised around each. These should be filed off with a flat needle file, care being taken not to cut down below the barrel surface. The manufacturers of telescope blocks usually mill the under side out so that only the two outer edges bear upon the barrel, allowing the center to be free. Such a bearing gives a much better support, as the blocks can then be firmly screwed in place with no danger of becoming loose from vibration. When screwing the block in place, first screw one screw down and see if it tightens the base to the barrel; then loosen this one and bring the other down. If each screw tightens the base properly when brought down separately, bring both down tightly so that the blocks will never become loose from recoil or vibration. When trying and tightening the screw in the block, note carefully whether it begins to tighten in the threads before the head comes down in the counterbore; see if the block can be moved with the fingers when the screw is tightened. If so, take out the screw and grind a little off the end at the point, and try it again. Full holding power of the screw should be obtained, but the end should not quite touch the bottom of the hole.

To make a first-class job, the blocks should also be "sweated" or soldered on the barrel. It will probably be best to shoot the rifle before this is done; you might want to change to a front block of different height and this can more readily be done before the block is soldered. If it is decided to sweat these blocks in place, it is first necessary to secure a perfect bearing surface between the barrel and bases in order to have a proper union of the metal. The blocks must be spotted in place; place a thin film of Prussian blue on the metal and file off the high points until a perfect bearing is secured. Some telescope blocks are case-hardened, and if so you will first have to anneal them before they can be spotted, and then case-harden them again before tinning.

The blocks having been spotted to a proper fit, they are screwed in place again and a line scribed around them; then they are taken off, and the bluing within the scribed area is carefully removed by filing. This is then polished nicely and the under parts of the blocks also cleaned and polished. Bearing surfaces of both barrel and blocks are now tinned lightly. After you have placed a very thin coating of solder on all bearing surfaces, screw blocks in place and heat moderately. The amount

of heat necessary should only be sufficient to melt the solder; you can do this with a small blow torch or by laying a heavy, hot soldering copper on each block until it melts the solder. As soon as the solder melts, tighten all screws and allow to cool. Blocks sweated in place by this method will never come loose from recoil.

Poor work in the fitting of both telescope barrel blocks and sight bases is usually the result of trying to aline the base with the eye, or of spotting the holes with a scribe, prick-punching the centers, and then drilling with a hand drill. The drill invariably runs out of the true center and the holes are tapped to one side or the other; then when the base is screwed into position it does not fit, or is at an angle to the alinement. Follow the principles outlined in the preceding paragraphs, and you should be able readily to obtain a neat-looking job.

As I have stated previously, too much care cannot be used when drilling for screw holes in any barrel; drill only to the correct depth and no more. However, accidents will occasionally happen to the best of workmen, and it may be that one of the holes you are drilling has broken through into the bore. The effect of this on the accuracy is very bad, and it may even be worse on the owner. If at all possible, a new barrel should be secured; but there are calibers and occasions where even this serious mistake may be repaired, provided the hole does not come through into the lands. If a screw can be fitted in the bottom of the groove, this should be done, and the end formed to the correct contour of the rifling. Considerable care and many trials at filing the radius at the end of the screw will take place before the proper shape is formed so that the eye cannot detect the repair.

Sighting In — Quite frequently, in the course of the year, there comes into my shop the individual who wants his rifle "sighted." This operation is generally amplified by instructions to "set the sight at the farthest distance it shoots flat." Now, we all know there is no rifle which shoots "flat" for any appreciable distance; but it is astonishing indeed to learn of the thousands of rifle users who still believe in this fallacy, and who also are perfectly willing to accept and use a rifle which has been sighted in by another person.

The final sighting in of any rifle should always be done by the user; at least he should check up on any alinement and setting of sights which may have been done by another. The gunmaker is, of necessity, required to verify the alinement of any sights or sight work he may do; but this should only be in the nature of a check or final test of his own handiwork. There already exists in current

rifle-shooting literature any amount of instruction on the sighting in of rifles, and the brief remarks made in the following paragraphs shall be given merely from the angle of the riflemaker.

When locating or substituting new sights on a rifle it is essential that they be placed in nearly the correct position, so there will not be much work entailed on the range when the opportunity is presented for the final sighting in. The simplest and most practical method of doing this preliminary sight setting is by means of the bore-sighting gauge, illustrated in Figure 120.

The bore-sighting gauge is the most accurate mechanical means we have at the present time by which the sights of a rifle may be set without going to the trouble of actually shooting the arm. As the average gunsmith seldom has the facilities for firing small arms around his shop, a set of suitable bore gauges is an absolute necessity; not only for metal-sight work but for telescopes as well. Furthermore, a gauge of this nature will save much time and ammunition when the actual range firing is reached.

The use of the gauge is simple; the bolt is removed from the rifle, and the front or bore gauge is inserted in the muzzle. This bore gauge is almost a "push" fit, and it has fine cross-wires; it may be inserted with these wires in any position, but it is best to fit it so there is one vertical wire in prolongation with the line of sight; that is, running up and down, with the cross-wires horizontal and vertical. In the case of a rifle shooting a center-fire cartridge, this bore gauge is all that is actually required, as the rear or chamber gauge need be nothing more than an empty, unprimed case having the flash-hole true and perfectly centered in the primer pocket. With a rim-fire rifle, it is necessary to make up a special receiver gauge such as illustrated in Figure 120; this same type of chamber gauge can also be made up for any center-fire caliber if desired.

With the bore and chamber gauges in place, the rifle is clamped firmly between the flat jaws of the vise and alined upon some suitable aiming point at a distance 50 or 100 yards away. Aline the cross-hairs of the bore sight accurately upon the mark; and then, without moving the rifle, proceed to bring the regular sights into the same alinement and setting as the bore sight. Check very carefully. An exact setting to the same aiming point as the cross-hairs cover would undoubtedly cause the rifle to shoot low; hence it is well to bring the regular sights on a point a trifle *below* the cross-hairs. In the case of fitting sights to a new rifle it will be desirable to leave the front-sight blade a trifle high; then when the actual range firing takes place a

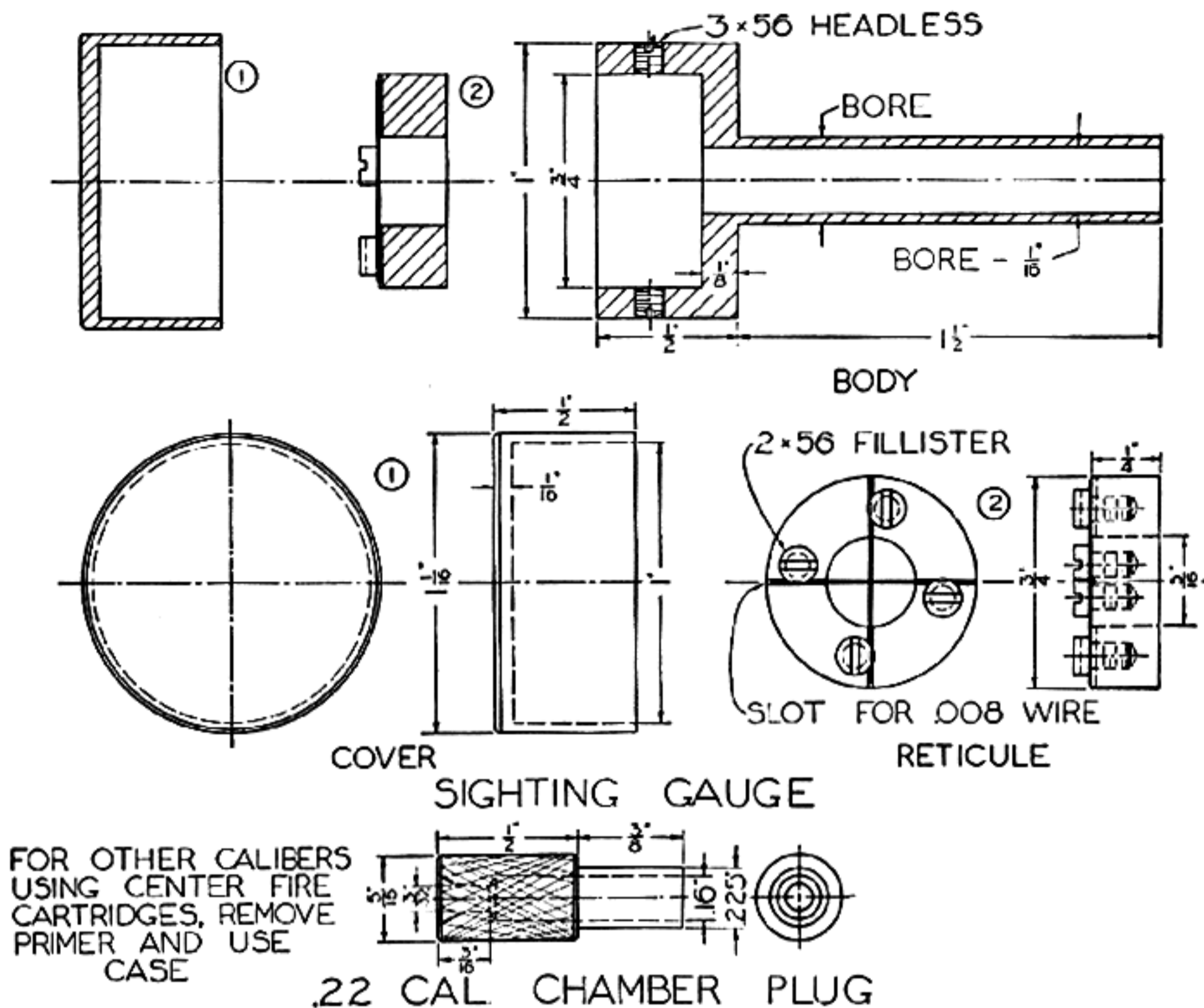

Fig. 120
Rifle bore sighting instrument

slight filing down will insure the setting being correct, and will also enable the rear sight to be set to its lowest possible position.

This set of bore-sighting gauges is of especial value to the target shooter who is also a user of the telescope sight. With the bore sight in place and the rifle wedged between sand bags on the firing line, it is a matter of but a few seconds' time, and no wasted shots, to bring the vertical wire of the aiming reticule in alinement with the wires of the bore sight; this, when accurately done, should put the first sighting shot within a few inches of the bull's-eye.

It is always advisable to fire the rifle over the actual range in order to check alinement and setting of the sights, and to give any final minor adjustments which may prove necessary. At this time we also give the sights their last settings, find their true zero, set for minimum point-blank range, etc. This work calls for a light brass hammer and a set of copper and fiber rods to be used as drifts in tapping the sights one way or another for slight adjustments. A few needle files may also be necessary in order to dress off the top of a sight blade or to deepen a sighting notch a trifle; and a reamer may come in handy to open up the aperture on a

peep sight. Keep in mind the rules relative to sight movement and their effect upon the target: that the bullet moves in the same direction with any movement of the rear sight, but in the opposite direction to any movement you make with the front sight. In general, the front sight should be set firmly and squarely over the center of the bore *and then let alone*; all necessary adjustments from then on being made with the rear sight.

The exact range at which the rifle is to be sighted will depend upon its caliber and the purpose for which it is used. In the case of a target rifle, a wide range of sight adjustment will be necessary and the exact sighting can be left to the owner. But with the high-power hunting rifle the case is different, and the average owner will undoubtedly want his rifle sighted to the longest and most practical "point blank" range possible. With cartridges such as the .30 '06, 7 mm., .270 Winchester, and .250 Savage, this setting should invariably be for 200 yards; such a sighting will cause the rifle to overshoot less than 3 inches at the 100-yard range, and this is much preferable to having the setting at 100 yards, which means that we shoot about 6 inches low at the 200-yard range.

As I have said, one cannot sight in a rifle ac-

curately and guarantee that it will shoot to this same point of impact for another individual. There are differences in eyesight and holding which may prevent it, but there are a surprisingly large number of sportsmen who do not realize this fact. Hence it may be well, when you turn a rifle over to a customer who is a skilled shooter, to advise that you have sighted it to shoot accurately in accordance with your own eyesight and holding ability. In the case of the "flat shooting" enthusiast who proposes to take the rifle right out into the woods and start hunting with it, better not say anything; the arm will undoubtedly shoot about seven octaves closer to the mark than he can hold, and your advice will undoubtedly be misinterpreted—and possibly resented.

Fitting Lyman No. 48 Special Sight—When remodeling a Springfield or any other bolt-action rifle on which the wood must be cut out for the clearance of the base and slide, it is better to cut the base of the sight and slide rather than the stock. When finishing the stock, carry the lines back with the loading gate on the right-hand side of the receiver, rounding the edge well in against the action, which gives the stock an even and unbroken line. The Lyman sight should now be attached to the receiver in its correct position. Lay a straight-edge on the flat portion of the loading gate. Scribe a line upon the sight base. By setting the receiver upon parallels, a surface gauge can be used to scribe this line completely around the base, including the slide. Remove the base from the action and strip it completely by removing slide, locking bolt, spring, and indicator. The elevating screw is removed and cut to length.

The base may either be milled, shaped, or cut off with a hack-saw and filed to the scribed line. The slide can also be done in a like manner. The lug by which the elevating screw is guided and attached is driven out from the bottom cut-off section, and relocated near the bottom of the cut-off slide.

First, reduce the lug to half its thickness and countersink it on the under side so that the screw, when riveted over, will give it a bearing point and at the same time a place for the expanded end of the screw to draw down the clip plunger and spring. Cut the elevating screw off, allowing for the riveted end. Turn the end of the screw so that it has a free movement in the guide lug. The end of the screw was threaded for a small nut and washer, but this now is discarded; the riveted end is more substantial.

The bottom of the slide which rests upon the base is filed off $\frac{1}{16}$ inch. The slide is allowed to come down this amount, and when the base is in position, mark the bridge of the receiver and file this portion out so that it is possible for it to rest on the face of the under side of the slide, the base, and upon the bottom filed-out section of the bridge. When the sight is in its normal position it sets well down, giving a $\frac{1}{16}$ -inch lower setting of the sight, which is very advantageous.

The spring slot on the left side of the base is filed in with a thin piece of steel and held with a small screw; a 3 x 56 is the recommended size, or one near to this size. The base should be sweated to the receiver, as there is such a small bearing surface left after removing the bottom section. Those who are not in a position to do this operation may tighten the two base screws as tight as possible; but always make a thorough inspection after shooting to see that they have not come loose in the act of firing. The sweating operation makes a perfect union and obviates the fear of having the base come loose on a long hunting trip with no screw-driver to tighten it with.

By cutting down the sight in this manner there is still $\frac{5}{16}$ inch to raise for elevation, which is more than is required for adjustments on a hunting rifle. The operation removes the spring which keeps the locking bolt in the elevating screw threads, but it is always an easy matter, after the rifle is once sighted in, to lock this nut in position with a pair of pliers.



Fig. 121

Springfield Model 1903 rifle designed for Mr. Charles G. King. Eighteen-inch barrel, Mannlicher type. Note Lyman 48 aperture sight with base cut off in line with loading cut-out in action

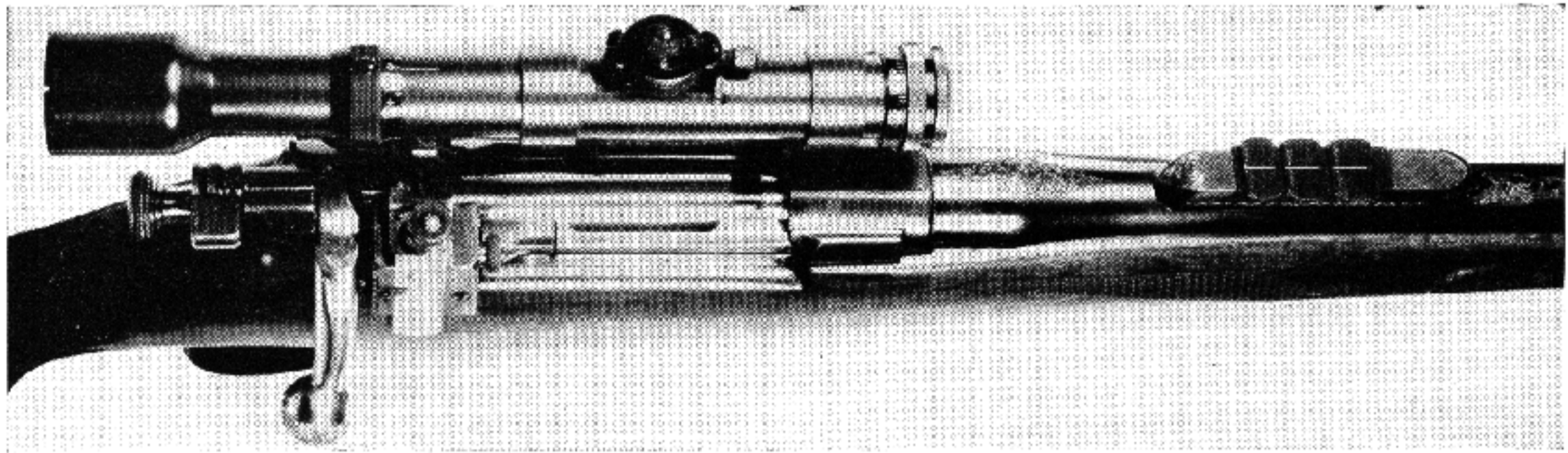

Fig. 122

Remodeled Springfield Rifle, Model 1903, with complete sight equipment. Note the leaf-sight base, and sight. Out-lines blend well and are in keeping with all other lines of the design

Acquire the habit of testing this nut to see that it is never loose. Some day the Lyman Gunsight Company will make this type of sight a standard for all sporting arms. Figure 121 illustrates this sight on a Springfield Mannlicher type made for Mr. Charles G. King.

Hunting Telescope Mounts — The development of a satisfactory telescope mount for the hunting rifle is still in the experimental stage, altho we have today a wide variety of commercial mounts to select from. The most recent as well as the most promising development is in the hunting telescopes, which have both windage and elevation adjustments within the tube itself. This idea, when ultimately perfected, will enable the construction of the most simple and sturdy mounts and will do away with much of our present troubles experienced with the hunting telescope.

There are two methods employed in the attaching of telescopes to the hunting rifle: one is the receiver side mount and the other is by means of top bases. The latter was the earliest method employed; it was a crude and unsatisfactory means of attachment, and today is seldom used. The use of the side mount is so general that I shall describe only the method of attaching this type of mount.

When mounting the telescope side mount to a receiver it must be placed on square in every direction. First, set the receiver upon parallels on the surface plate and place the base fixture in position, as far back on the receiver as possible, holding it in position by two "C" or parallel clamps. The top

of the plate must come in perfect alinement with the axis of the bore of the rifle; then it is possible to have the aiming post of the telescope come in the center, which gives considerable adjustment one way or the other: i.e., elevation or depression. Place the try-square against the flat side and have it come into position against the blade of the square until all light is shut out, and then tighten the clamps. Now, test it for square from the top by laying a small square over the top with the small blade down, bringing up against it the square which is resting on the fact plate. Using the same method as when setting telescope blocks in place, hold the receiver in the light so you can test the base to see if there is any light between it and the receiver. If such a condition exists, remove the base and spot it in; but as a general rule, the manufacturer has milled the base out so perfectly that it does not require any spotting in. Should it fit properly, the receiver is now ready to be drilled and tapped.

These base plates come drilled with five holes, three of which are counterbored to take fillister-head screws while the other two are for tapered dowel pins. The necessary screws and dowel pins come with the mount. Use a drill which will just fit the screw holes and spot the three holes to secure the center; then, with the right-size tap drill, continue through the metal of the receiver. Keep right on and tap the screw holes while the base plate is in position. Screw the three screws in place and file off their ends flush with the walls of the channel. Figure 122 illustrates a rifle with full sighting equipment.

CHAPTER XVIII

Replacement of Small Working Parts

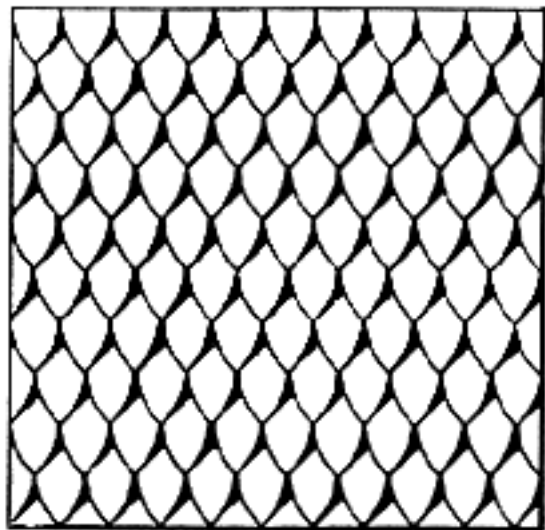

Replacement of Small Working Parts

THE ultimate success or failure in fitting new parts to the mechanism of a firearm depends primarily upon two things: friction and tolerance; therefore the student should be informed on these subjects before going any further. Friction is the term applied to the resistance to motion that occurs when one body is moved upon another, or, as generally defined, "that force which acts between two bodies at their surface of contact so as to resist their sliding on each other." This, of course, is applicable to the working parts of a firearm. Tolerance, as we generally know, means endurance; but technically it is used to denote the maximum and minimum size between two given diameters or the greatest dimension allowable on a given part. Tolerance is the allowable difference in which two separate bodies will work in harmony with one another without undue friction.

Prior to and during the World War the standard on all small-arm gauges was a given size with no variations of plus and minus to work to. Such close measurements on a gauge, of course, meant the most rigid of precision work, even tho there was 0.006 inch difference between the maximum and minimum diameters on the pieces to be gauged. Consequently such a system slowed up the production of gauges right at the time when they were most needed in the manufacturing division. This necessitated replacing the old standard with a manufacturing tolerance for the small-arm gauges. It was later adopted for all gauges and is today the standard for all instruments for measuring component parts.

There are several laws of friction which should not be overlooked by the student. These are as follows:

(1) For low pressures: the friction is directly proportional to the normal pressure which becomes abnormally high, and the friction increases at a rapid rate until seizing takes place.

(2) The friction both in its total amount and its coefficient is independent of the areas in contact, as long as the total pressure remains the same. This is true for moderate pressures only. For high pressures this law is modified in the same way as in the first case.

(3) At very low velocities the friction is inde-

pendent of the velocity of rubbing—as the velocities increase, the friction decreases.

After comprehending these laws you can determine the tolerance for nearly all the working parts of a firearm. Where a surface comes in contact with another surface and they travel against one another, both should have a hardened surface, highly polished and well lubricated. This reduces friction to a minimum, whereas if the opposite condition should exist, the retarding force will increase friction to such an extent that the operation of the parts becomes sluggish. When new parts are ordered from the factory they are usually slightly oversize and in a number of instances have deep tool marks which must be removed if any point is a bearing that would cause friction.

In the manufacturing of all tools, gauges, dies, etc., also the making of repair parts, a finish is placed on the essential working parts and all other surfaces are left in a semi-finished condition. Therefore, another dividing line is drawn because of labor cost in industry. Realizing the labor cost, you must not condemn a repair part when it is delivered into your hands. The particular piece you received may have cost you only sixty cents. But by keeping track of the time you spend in finishing this part, valuing each hour at \$1.50, you would soon admit that had you paid for manufacture and labor for finishing you would have just cause for complaint. It is typical of American people to view everything in terms of dollars and cents. They are more influenced by the price of an article than its finish. The American manufacturer, always anxious to please the dear public, puts out his respective product as cheaply as possible. The dollar watch and model-T Ford are examples of this, as is the double-barreled shotgun sold for \$20 and under. In every instance you are getting exactly what you pay for. The working parts are generally made from cold-drawn steel improperly hardened, and consequently the finish is poor.

When you are refitting the working parts of any cheap arm, you should first study the essential ones, remove the tool marks, and polish and harden them to the proper degree. If you find it necessary, you can either make new parts or pur-

chase them from the factory. First polish the contact surfaces in the most convenient manner and coat them with the coppering solution given in Chapter XVI, Volume II. The purpose of the copper plating is to give the exact bearing surface to be worked upon, for such points will cause the greatest amount of friction.

It may be necessary to reassemble such parts a number of times to work these in the action, removing the high points until a perfect bearing is established the full width or length of the part. Generally, all parts are hardened or toughened at the factory, and instead of a fine file, various India or carborundum oilstones must be used. Care is to be taken that you do not have rounded surfaces. After removing the high points, coat again with the solution when the part is assembled, so that the true contact points have a perfect bearing. Figure 123 will give an illustration of just how much care is used in one of our large arms plants in the assembly operations.

Hand fitting of parts requires particular patience and care in the installation of all lock and action mechanisms. However, the student does not get a great amount of this class of work except when making new guns or fitting special parts made for replacements. Even tho the gun is in perfect working order, duplicate some of the working parts of a shotgun of American manufacture such as the sears, tumblers, or cocking levers. If you have the machinery, also duplicate the locking mechanism. Make each part of the best steel and apply the proper heat treatment and temper. Such experience will teach you what tolerance is required between certain given points and also the points where friction and resistance are the greatest. Take, for instance, the radii on the ends of the cocking levers. Study the motion of these against the tumblers, and suppose they should have a square face in place of a radius. Such a large bearing would cause a grinding movement when opening the gun. Remove these same levers and place a perfect radius on the end which is rounded, and then install them. There will be a vast difference, since the friction was eliminated at that point. It is that which comprises the difference between a gun of low cost and one more expensive. Perfect fitting and timing was the paramount issue in the latter class.

Take a high-grade arm in your hands with snap caps in the chambers. Now open and close the action. Note the free operation of the cross lever. Bring the gun to your shoulder and point it at some object; remove the safety and fire, first right and then left. Notice the clear ringing sound as the tumblers come down on the caps. The trigger-

pull is perfect. Open the gun and see what a quick movement there is of the automatic ejectors when it reaches a certain position, throwing the snap caps a distance of five feet or more. Such perfect workmanship is only found on the best guns—placed there by men who knew what friction and tolerance meant.

I knew one man who made very fine trap guns. After he made a perfect fit with the highest degree of polish possible he would place a fine film of oil



Fig. 123
Hand fitting operation on small parts as performed in the large arms plants

and rouge on the surface and with his fingers rub for hours to secure a higher polish on these metal parts. To handle his finished guns was a never-to-be-forgotten pleasure and left one speechless with admiration. But there are very few men who will pay for such workmanship in the United States, and the man I described who only turned out the best, died penniless. All his guns were on special order and made complete, at a cost of one thousand dollars. On one gun he invested two thousand dollars in labor alone.

The lubricating surface of a highly finished part is of material importance, for the laws governing a well-lubricated surface are considerably different from those applied to a poorly lubricated one. We must use an oil whose value as a lubricant depends mainly upon its film-forming capacity. Turn to Chapter XXV, and use either No. 1 or No. 2 for

the lubricant on the finished surfaces. This will allow for free movement of the bearing surfaces at all times. If the bearing surfaces are flooded with oil, the friction is almost independent of the nature of the material of the surface in contact. As the lubrication becomes less ample, the coefficient of friction becomes more dependent upon the material of the surfaces. For that reason we must have such parts drawn to a toughness that will keep them from picking up or adhering to metal until they can be lubricated again.

When the student has an unlimited amount of time and desires to do particularly fine work on the described parts, a number of lapping operations may be attempted, as described in Chapter IV. On a number of parts of a firearm it is almost an impossibility to use any form of flat lap, and when possible it is better to construct special laps of either cast-iron or copper to produce a fine bearing surface and a high finish to eliminate friction. There are a number of places where round laps can be used for the desired degree of tolerance and fit. These should be used wherever possible.

When new pins, screws, etc., are fitted to any firearm, we refer to different kinds of fits which are in ordinary machine construction. Five classes of fits are most commonly used: running fit, push fit, driving fit, forced fit, and shrinkage fit. The running, as its name implies, is employed when the parts must rotate; a push fit is not sufficiently free to rotate. The other classes referred to are used in assembling parts which must be held in a fixed position. When the allowance is smaller than for a running fit, and a moderate pressure is required in assembling the parts, the term "push fit" is sometimes used. The tolerance required for running fits on all cylindrical parts in gun work is between 0.0003 and .0005 inch. In other classes of work, however, the tolerance often increases with the diameter but may be varied according to the length of the bearing surface. As most of the parts in firearms are small, in a number of cases we must reduce the allowance, provided the arms are not of an automatic nature. On such parts care must be used to have a well finished bearing, the holes lapped, and all parts with the correct temper so they never freeze or gaul. ("Gaul" is a term used when two soft metals bind to each other.) The factors which govern such tolerance may at times have to be increased or decreased. Here is where your best judgment is used.

In the construction of parts that require less or greater labor on certain parts of firearms, no tolerance is allowed. Then we refer to a "forced fit," which means that a pin, shaft, or other cylindrical part is forced into a hole of a slightly smaller diam-

eter. As a rule, forced fits are restricted to very few parts in gun work; as an example, on a shotgun, between barrels and action. The hinge bolt must be a forced fit in the frame and at the same time it must be free enough on the lug to allow the complete closing of the gun without any loss in motion whatever. The proper tolerance for a hinge-bolt fit depends upon the mass of metal surrounding the hole, the size of the work, the kind and quality of the material of which the parts are composed, and the smoothness and accuracy of the pin and surface of the bore. Such a hole on a shotgun should be lapped to remove all tool marks of the reamers, and the hole should be a perfect and highly polished sphere. The personal factor is much in evidence in work of this kind, but when a job is finished in the proper manner there is no come-back at some future period.

When fitting a hinge bolt to a shotgun always clamp the barrels and action tightly together. Then ream and lap the hole which will include the radius on the lug. Some advise peening the lug at the radius and then stoning it out, but this is very careless. It will tighten a shotgun for a short time, but after a number of shots are fired the gun is as loose as it was in the beginning. The only way to produce a perfect joint is by reaming and lapping the hole so that the radius on the lug and the metal is compact and free from tool marks.

As almost all the parts must rotate in some manner, shrinkage fits in firearms are rather restricted, altho in general practise a considerable amount of this is done in machine construction. Shrinkage tolerance exceeds those of forced fits. In any case the shrinkage allowance varies to a great extent with the form and construction of the part which has to be shrunk into place. This thickness or amount of metal around the hole is the most important factor. Whether parts are to be assembled by forced or shrinkage fits depends upon conditions. This practise may often be done for certain operations in the shop, but in firearm construction you will find little use for this class of fits.

In making new parts for any firearm see that all surfaces are flat and all edges square and true; whenever it is possible on flat surfaces, the parts should be lapped. When a file is used, see that a true flat surface is made and that the oilstone is used when necessary. See that you do not lift, roll, or tilt them at all, and when bringing the part down to the final finish and size, try to file, polish, or stone in one direction if possible. When testing the new parts, first try them dry. When they begin to enter, apply a small amount of oil on the surface, provided you are not using the coppering solution.

When making special parts the student will also find it necessary to make various tools, such as counterbores, reamers, broaches for square and odd-formed holes, special dies, laps, etc. Threads in many guns are different from the standard, and

in a number of cases special taps must be made and even small screws must be made on a lathe. From beginning to ending of any special job in gun work you must find some means to accomplish your undertaking.

CHAPTER XIX

Hand-forging and Heat-treatment

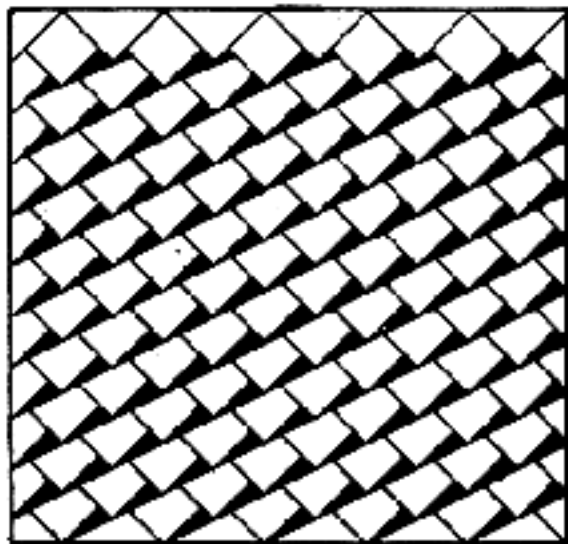

on the inside plate. These will be used to control the flow of air. Also, in a convenient location, attach a damper so it will be possible to control the flow of air to the furnace. Tap the top and bottom of the fan chamber and fasten brackets so that it will be possible to clamp the blower in position.

Blacksmith forges require air pressure varying from one and one-half to six ounces per square inch. Small forges with the blower close to them are adequately supplied with one and one-half ounce pressure. If the blower is farther away, have a long discharge pipe lead to the forge with many bends, even tho the latter be small. It may be necessary to carry three ounces pressure or more to overcome the friction in the air ducts. Large forges usually require from three to six ounces pressure.

If you do not have gas or regular electrical connections, you can buy a small foot bellows, which may answer very well for what gun work you will wish to do. If you expand you will need and get larger forge equipment.

A description of the anvil is given in Chapter IV. This must be placed on a solid hardwood block, and its height should be so that in standing beside it the knuckles of the hands will just reach the top surface. Tongs are of different lengths and forms, adapted to the work to be held. You will need two in every welding operation, but these will be of simple form and they will doubtless serve all your requirements.

Fuels for the Forge—Coke, coal, charcoal, oil, and gas are used as fuels for heating iron and steel for forging and welding. For general work, a coke fire is the best, altho bituminous (soft) coal is extensively used. When anthracite (hard) coal is used, it is difficult to get a hot enough fire, especially on a small forge. Coke or bituminous coal should be low in sulfur content, because sulfur, lead, bronze, or brass must not be in the fuel or fire that is used for heating iron or steel. A weld may be ruined by throwing brass filings into a fire before heating the work.

To fire any forge, cover the entire hearth with fine coal, assuming that coal is to be used, to a depth of two inches. Hollow out the center over the trap and perforated plate; on this, place wood shavings or excelsior, and light. When this begins to burn, rake a small amount of coal around the fire until it is completely covered. During this time you are gently forcing air through, allowing a steady burning of the material used to light the fire and the coal. Gradually work coal up into a mound, having a small crater in the center. The mound should be large enough in diameter and

also in height to accommodate the work you wish to do. When the fire is well under way in the center, sprinkle water on the surplus coal on the hearth and around the fire. Thick yellow smoke will show that the sulfur and other impurities are burning off and producing the clean fire required to work any metal. You will find that the coal around the fire has begun to turn to coke, which burns with a clean bright fire, free from all impurities. After completion of all necessary work in the forge, allow the fire to die out naturally. When starting a new fire, all that is necessary is to remove the center, allowing the mound of coke to remain, and saving the coke produced from the new fire. In this way you will always have a supply of coke on hand which is nearly equal to any you could buy. Even poor soft coal may be turned into this form of fuel, which will answer for many purposes.

The hand forging of steel requires two different rates of heat. If the piece of metal merely requires a smoothing of the surface of the stock, the so-called "cherry-red" heat is the amount required. Smoothing is performed by striking lightly and evenly with the hand-hammer until the desired surface is secured. This same degree of heat is employed when "hammer-hardening" the steel is one of the objects. In this case, the blows of the hammer must be heavier than in the former case.

If the forging is to effect a material change in the shape of the object, the rate of heat must be increased to what blacksmiths call the "white-flame heat." The hammering also must be much heavier.

Welding — A "welding" or sparkling heat is required in this process; it is a much higher degree than forging heat. To get this heat the metal is brought nearly to a state of fusion; this condition is detected at once by its sparkling and its glazed appearance, showing that the iron or steel is on the verge of melting. As soon as the two pieces to be welded together have both attained this temperature, they are taken from the fire with the greatest speed, and the "scale" or dirt which would hinder the incorporation is scraped off. They are then placed in contact at the heated point, and hammered until a perfect union has been effected and no seam or fissure remains visible. If the first effort fails to unite them sufficiently, they must be reheated and rehammered.

The fire for welding, if coal is used, should be free from sulfur, and the iron or steel while heating should be often taken out and sprinkled, at the point of the greatest heat, with powdered glass to which powdered clay has been added. These applications tend to prevent the iron from burning,

Hand Forging and Heat Treatment

FROM the days of Tubal Cain the smith has occupied an important place in human society. He even has a place among the gods in the old mythologies. He made the most indispensable things, the things that differentiated men from animals—tools—and the tools made everything. Probably, after fashioning the simple tools of husbandry, his next task was the implements of the chase; thus our modern gunmaker is of his own race and kindred.

Personally I regret the passing of the village forge and the stalwart blacksmith playing with fire. The rhythmic music of the anvil and the coruscations from the smelted metal have inspired and cheered men, poets, and children of all ages. What is there in a car and a garage that compares with the horse and a smithy?

As a boy the blacksmith's shop was my house of magic; here I got the first taste of what was destined to be my life's work. Is it not remarkable how much the open mind of the child absorbs? What I saw Mr. Berthelson do and what I heard Mr. Berthelson say in his kindly answers to my innumerable questions are still a part of the store of information that I am passing to you.

The fire and anvil work required in the fabrication of the hand-made gun, or perhaps I should say those parts of a gun that we must fabricate to obtain, are not beyond the capabilities of the man who has been game enough to tackle gunsmithing. There are certain basic principles that govern the manipulation of hot metals; these must be known and practised, and so in this chapter I am going to tell you the theory of it—you will have to acquire the rest in front of the forge.

In this machine age, the parts comprising a fire-arm are mechanically produced in multitudes of ingenious processes. These parts are finished to a remarkable accuracy so that the hand work in assembling them is very little. These parts, in all commercial arms that are at all current, are obtainable from their makers; in your repair work you will always be wise to buy these parts rather than to attempt making them, as their cost is only a fraction of the cost of labor and material your hand work would entail. However, arms soon become obsolete, new ideas are constantly sweeping

them into discard, and repair parts become unobtainable. Here is where your knowledge of forging becomes invaluable, for old guns like old friendships are long retained and must be constantly renewed.

The parts that require replacement are naturally those which have the hardest wear or those which from their location are most susceptible to accidental injury. Hammers, springs, guards, tumblers, sears, triggers are some of them.

In addition to the working of metals, there is another phase which finds its place in this chapter, and that is the heat treatment of steels, their hardening and tempering. This is only second in importance to the metal itself.

Blacksmith Equipment—The equipment for forging consists of a forge, an anvil, tongs of various sizes and shapes, hammers of different weights, and cutting and forming tools which attach to the "hardie hole" in the anvil, and a "slack tub" for quenching. The kind of forge you will have will be determined by the amount of use you will have for it and the fuel you will have to use. If gas is available, it will be an inexpensive purchase, or one can be easily constructed out of junk material. It will have to be equipped with a blower or bellows so that we can get an air pressure of about four ounces to the square inch in order to get welding heats.

Let me describe a simple home-made forge which will answer almost every purpose and cost very little money. It is made from an automobile brake drum picked up in a junk yard. The legs are made of angle iron and the center is built up of fire brick and fire clay. This particular one is made for gas. If it were designed for coal it would have a trap in the center opening where the air-pipe comes in. For the blower an old vacuum cleaner is used.

Strip all the parts from the cleaner, and where the dirt bar is attached, attach a sheet-metal tube, this to be connected to the air inlet of the furnace. With a hack-saw remove the wide floor intake, care being taken not to cut into the fan chamber. Over the fan chamber intake, attach a plate with four $\frac{3}{8}$ -inch holes so they will match with the holes

and they assist adhesion when the two pieces are brought into contact at the moment of welding.

Classes of Welds—Welds are classified by the way in which contact points are formed prior to making the weld. The welds ordinarily made in hand-forging practise are the scarf weld, butt weld, lap weld, cleft or split weld, and jump weld. They are shown in Figure 124. It will be seen that the

slowly to secure a uniform temperature throughout the portion to be heated. With too rapid heating, the outside only may be raised to the welding temperature while the interior below is not hot enough. In this case a compact weld would be impossible.

Fluxes for Welding—Wrought iron can be heated to a high enough temperature to melt oxid,

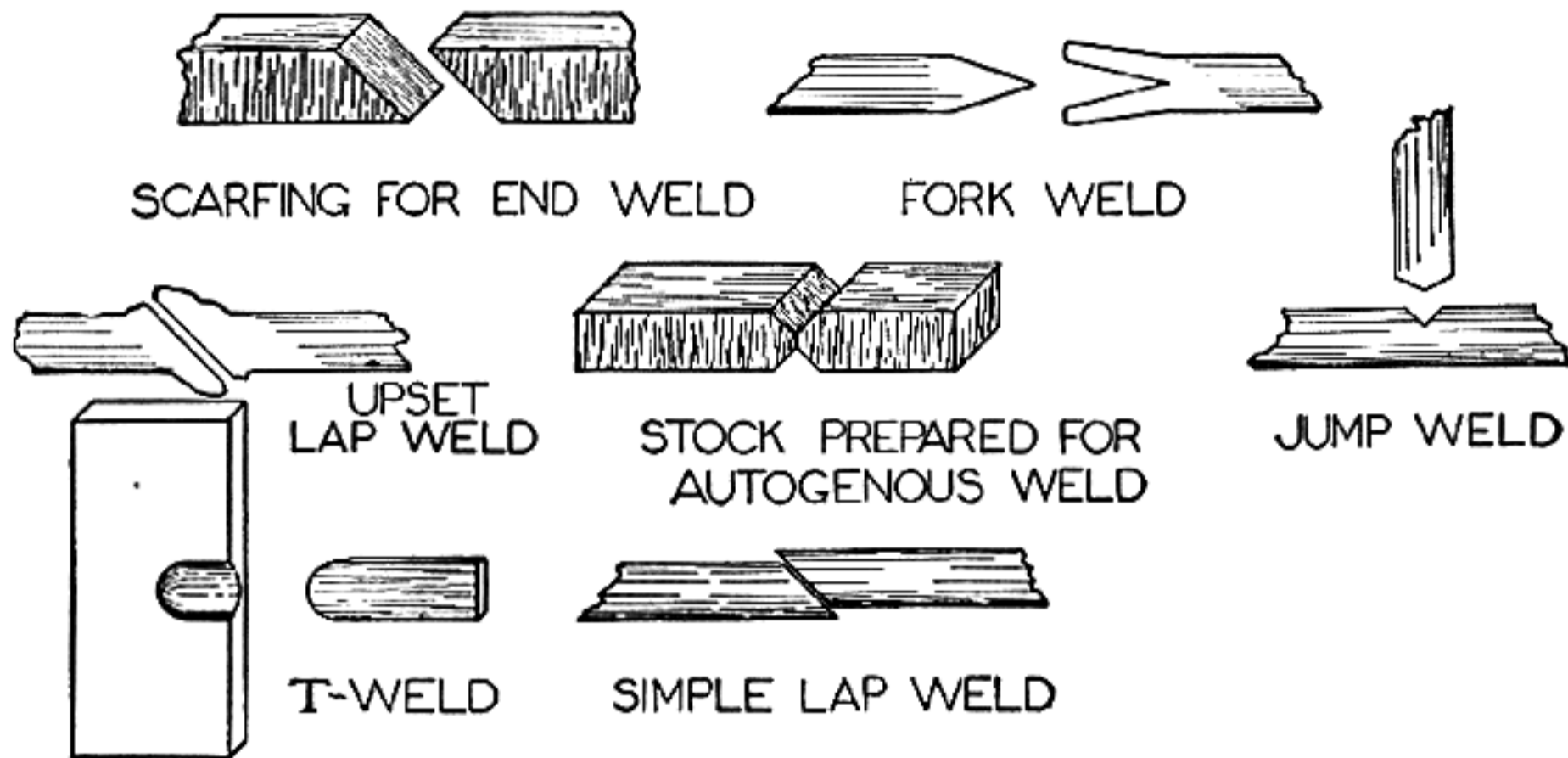

Fig. 124
Preparation of metal for welding purposes

surfaces, in most instances, are rounded or crowned. This is done so that when the heated parts are brought together they will unite first in the center. Any slag or dirt which may adhere to the heated surfaces will then be forced out as the welding proceeds from the center outward. When making a lap weld, the hammering should begin at the center in order to work the slag out, as the faces in this case are not rounded. When forming a weld it is generally necessary to "upset" the contact points—that is, to accumulate extra metal at the points by forcing the metal back on on itself. This, because in hammering you necessarily elongate. If the metal has been "upset" the elongation will not rob the metal of thickness.

Welding Heat—When two pieces of wrought iron or mild steel are heated until they become soft and plastic and will adhere when pressed or hammered together, they have reached what is commonly known as a "welding heat." If the ends to be heated are not hot enough, they will not stick together; inversely, if the work remains in the fire too long, it becomes overheated and burned, which greatly injures the metal. Iron which has been overheated has a rough spongy appearance and is brittle. The danger of burning is increased when the air blast is too strong and the fire is highly oxidized. It is important to heat the work

which may be forced out from between the surfaces by the hammer blows; but when welding machine-steel, and especially tool-steel, a temperature high enough to melt the oxid would burn the steel, and it is necessary to use what is called a "flux." This is composed of sand, ground glass, or borax. Since these have a melting temperature below the welding temperature of the metal, they readily dissolve when sprinkled upon the heated parts at the time they have reached the yellow heat. The flux serves two purposes: it covers the heated surfaces, which protects them from oxidation, and when molten, aids in dissolving any oxid that may have formed—the oxid melting at a lower temperature when combined with the flux.

Wrought iron can be welded in a clean well-kept fire without using a flux of any kind, except when the material is very thin. The fluxes most commonly used are fine clean sand and borax. When borax is used, it will give better results if previously burned; this can be done by heating it in a crucible until reduced to a liquid state and then pouring it on a flat surface to form a sheet. When it is cold, it can easily be broken and pulverized. Borax can be used either alone or mixed with an equal quantity of fine clean sand and about 25 per cent of iron—not steel—filings; for tool-steel a flux made of one part sal ammoniac and twelve

parts borax is recommended. When pieces are hooked together previous to welding, as in split welds, or when a second heat or "wash" is taken, a flux that will flow easily should be used. There are many welding compounds on the market, some of which are best suited for one class of welding and some for another.

This is a great amount of information for the beginner to digest, and I suggest that he practise on small pieces at first. Forge out the hooks and tongs which you will use at the forge and Bunsen burner. Make a broach for cleaning-rod eyes. Forge the ends of these rods and place the small eye in the end. You will find a considerable amount of preliminary work necessary in making special drift punches, scribes, center punches, and chisels, both for your wood-working and for your metal work. Then take test pieces and see what results you are able to secure in welding two pieces of the same material together. Welding tool-steel to machinery-steel and welding inserts of tool-steel on or in machinery-steel will be another step.

Hardening and Tempering—We now pass to the second stage of metal working, that very important phase of heat-treating: hardening and tempering. This is the process that gives to iron and steel various degrees of strength, freedom from internal stresses, hardness, elasticity, and ductility.

Heat a piece of steel to a bright cherry-red and plunge it at once into cold water. You have instantly made it as hard as fire and water can make it. It is now almost as hard as glass, and so brittle that it will not stand up under any of the uses to which tempered steel is applied. This that you have just done is the preliminary step to be used in all tempering and treating, for in doing this, we have driven our metal to a condition of fixation from which we can work backwards to any point of hardness we may desire.

This is accomplished by reheating the metal and quenching it at some previously determined point. This point could be determined by means of a pyrometer, but nature has kindly placed in our hands a ready means of determining temperature in steel by giving different hues to the cooling metal. Nine shades are readily distinguishable, and each is the index to certain well-known conditions. We list here these colors and the temperatures they indicate. We also indicate what steel of this particular hardness is suitable for:

1. Very faint yellow, denoting a temperature of 430 degrees Fahrenheit. If plunged into water at this color, the piece will be very hard, having a temper admirably suited to draw dies, bullet dies, bullet swages, forming dies, and reamers.

2. Pale straw color, 450 degrees Fahrenheit. Still very hard and suitable for the faces of hammers, forming dies, and counterbores.
 3. Full straw yellow, 470 degrees Fahrenheit. Various forming dies.
 4. Yellow brown, 490 degrees Fahrenheit. Threading dies for tool steel, piercing punches, gravers, turning tools, knurls.
 5. Brown with purple spots, 510 degrees Fahrenheit. Wood-working tools. Most of the parts in shotgun locks, with the exception of the spring, threading dies for general work, taps $\frac{1}{4}$ inch and under.
 6. Light purple, 530 degrees Fahrenheit. Butcher knives, and other flesh-cutting implements. Threading dies to cut closely to shoulders, drift punches, and small piercing punches.
 7. Dark purple, 550 degrees Fahrenheit. Tools requiring strong cutting edges without extreme hardness, such as chisels and small piercing punches.
 8. Full blue, 560 degrees Fahrenheit. Axes, various fine tools requiring strength, and taps under $\frac{3}{32}$ inch. Firing pins for both hammer shotguns and single-shot rifles, also double guns.
 9. Dark blue verging on black, 600 degrees Fahrenheit. Saws, swords, and the like.
- Steel at 700 to 725 degrees Fahrenheit is suitable for springs.

Various other methods of tempering steel are sometimes recommended, such as quenching in a mercury bath or in divers solutions such as sulfuric acid, milk, wax, tallow, and salt water; but since the amateur gunsmith will find no use for these methods, it does not seem proper to encumber this book with anything further on the subject of tempering. We might add, however, that the hardest degree to which steel can be brought is secured by heating the piece to a dull red or cherry-red and instantly plunging it into cold mercury.

The shape, size, and requirement of the material or object will have a great influence not only on the temper required, but also on the means of acquiring and placing the temper. If the piece under process is an edge-tool of considerable bulk, only the cutting edge and the metal a little back of it is plunged into the water at the hardening, the rest of the implement being left still hot. It is then held in the light and observed closely, when the different colors, indicating the different degrees of hardness, will be seen moving slowly one after the other down toward the edge, driven by the heat still left in the main part of the metal not plunged. When the color desired has reached the edge, the entire piece is plunged into the water bath, which stops further action of the heat and establishes the degree of hardness exactly where it is desired.

This method has had two objects: you will notice, for one, that the edge of the tool has been given its required hardness; for the other, that the toughness and strength of the rest of the tool has not been impaired. To have the "eye" of an ax as

hard as its cutting edge, for instance, would be disastrous to the ax.

Very light articles and implements cannot be tempered in this way, as they will not retain sufficient heat to drive the colors, and it will be necessary to release them gradually in some way to make the colors move. Very light pieces, such as scribes, small taps, etc., are best tempered over a Bunsen burner or alcohol lamp. After having been hardened, they should be held in the flame of the Bunsen burner or lamp until the required color has appeared, and then quickly plunged into water. On large articles the colors will generally be so strongly marked that they will be readily discernible on the rough surface of the metal; but on smaller articles they will be faint, so it is best to give small articles a slight polish, either on a buffing wheel charged with emery or with emery cloth fastened to a large file or flat piece of hard wood, before exposing them to heat. The color then will be easily seen.

Tempering Knife Blades—To heat the blades, lay them in a clear charcoal fire, with the cutting edges downwards. Heat very slowly. It is best that the back of the blade, which is uppermost, is not so hot. Harden in clean water at a temperature of 95 degrees Fahrenheit. If many blades are to be hardened at once, lay a number in the fire and remove one at a time as they become properly heated. To temper, polish with fine emery cloth so that the tempering color can easily be seen. Bend up a sheet-metal pan and fill with fine sand, laying this over the charcoal fire, and place the blades, backs down, in the sand, the cutting edges uppermost. When the proper color is seen on the polished portion of the cutting edges, remove and plunge into cold water. When an extra-tough blade is wanted, after hardening, handle it so that it will not draw any lower after removing, and let it cool without putting in water.

Long blades, when they are being drawn, can be straightened if necessary by putting them between two pins in the anvil or elsewhere and bending them. Surprising as it may seem, when hardened steel is being drawn it can be bent to quite an extent, and when cool will remain as bent. File makers straighten files in this manner. Sword blades and blades of butcher knives undergo the same process of manipulation in order to be kept straight.

Tempering Firing Pins and Extractors—The heat treatment of firing pins and extractors is very much like that of springs, inasmuch as they are hardened first in the regular oil bath, the heat having reached the correct degree before plunging into oil. They are polished after being withdrawn

and placed again in another oil bath which has been heated to between 550 and 600 degrees Fahrenheit. Allow them to remain with the bath at this temperature for thirty minutes. I believe that the amateur has more trouble with these than with any other parts of a gun except the springs. One of the best steels for extractors is case-hardened cold-drawn steel. The common water-hardened chisel steels and drill rod are fair for firing pins, but when making such parts as these it pays to buy the best. The lead pot is the best means of heating these parts, for you are able to obtain an even heat throughout. Generally the large number of broken pin tips have resulted from heating the small section first to a higher temperature than required, plunging this into water, drawing the temper over a gas flame or alcohol lamp, and allowing the temper to run up to the point. The result is a soft end where the hammer hits, which upsets in time, causing the pin to shorten—if it should last that long. By drawing the temper to the correct degree of heat, there is an even hardness throughout the steel. If the point on a firing pin should be bent, do not try to straighten it while cold, but heat it to a cherry-red and then straighten. Then harden and relieve. Whenever this happens it is best to make a new pin, as the structure of steel has been fractured to such an extent that the tip will break in time.

Quenching Baths—To get the very best results in tempering, two baths are necessary. The water bath—incidentally this should be rain or distilled water—and the oil bath. The first, the water bath, is the one you will use exclusively for carbon steel. The oil bath will be used for alloy steels and high-speed steel. The oils used for this bath are linseed, whale, fish, lard, and lard and paraffin mixed, special quenching oils, etc. A small quantity of sal ammoniac added to the oil bath has a tendency to make the tools come out clean from the bath. The oil bath for hardening springs used in gun work is composed of the following:

1 quart linseed oil
1 " paraffin oil
 $\frac{1}{2}$ pound sulfur melted
 $\frac{1}{2}$ " rosin melted
1 pint fish oil

Melt the sulfur in a separate receptacle, also the rosin separately. Heat the oils together to the boiling point and add the sulfur and then the rosin. Agitate until all are thoroughly mixed together. Keep this in a covered stone crock.

Oil-Heating Baths—These are extensively used for tempering tools which do not require a higher temperature than 600 degrees Fahrenheit. The

work is immersed in oil heated to the predetermined temperature, a temperature which must be indicated by a pyrometer. It is important that the oil have a uniform temperature throughout and that the work be immersed long enough to be brought to this temperature. Cold steel must not be plunged into a bath heated for tempering, owing to the danger of cracking it. The steel should either be preheated to about 300 degrees Fahrenheit, before placing it in the bath, or the latter should be at a comparatively low temperature before immersing the steel and then heated to the required degree. A tempering oil which has given satisfactory results in practice has the following characteristics: composition of mineral oil 94 per cent and saponifiable oil 6 per cent; specific gravity 0.920, flash point 550 degrees Fahrenheit, fire test 625 degrees Fahrenheit.

The Potassium-Nitrate Heating Bath—This is used for pieces requiring a temperature above 500 degrees Fahrenheit, and to a point where the tempering colors reach 750 degrees. The temperature must also be indicated with a pyrometer or thermometer, especially in the case of springs. These last, to secure the best results, must be given a temperature of between 700 and 725 degrees, keeping the bath at that temperature and letting the spring soak at least ten minutes before removing. A cold spring should never be plunged into the bath, but preheated as before mentioned. When these instructions are followed, springs thus tempered will never break, providing fine British spring steel has been used.

The Lead Bath for Hardening and Tempering—Among the many secrets of hardening is the employment of the lead bath, which is a quantity of molten lead kept liquid over a fire. The uses of this bath are many. For instance, if it is desired to heat an article that is thick in one portion and thin in another, it is apparent that it would be difficult to heat the thick portion without overheating the thin part. If the lead bath is brought to and kept at a red heat, no matter how thick the articles may be, in sufficient time both the thick and thin parts will be evenly and equally heated, and no hotter than the bath in which they are immersed. The bath of lead must be covered with charcoal to prevent oxidizing, as lead begins to vaporize at about 1190 degrees Fahrenheit, and when heated above that point rapidly volatilizes, and in so doing gives off poisonous vapors. A heavy layer of charcoal prevents this rapid vaporization. To prevent hot lead from sticking to parts heated in it, mix common whiting with wood alcohol, paint the part to be heated, and let dry before immersing in the lead. For heating thin cutting

blades, springs, small taps, threading dies, draw dies, etc., this bath is unequaled.

To Restore "Burnt" Steel—Pulverize together two parts horn or hoof filings, one part sal ammoniac, one part charcoal, and one part common soda. When thoroughly ground together, work in enough tallow to make it into a paste. Bring the damaged steel to a bright cherry-red and then cover with the paste, letting it cool gradually. The process may be repeated several times with profit if the steel is badly burnt. While a piece of badly burned steel may not be entirely restored by this process it can be much improved. Entire restoration is scarcely possible.

To Anneal Steel—Heat the steel to a cherry-red in a charcoal fire, then smother the fire down with a thick layer of ashes or sawdust, leaving the steel in just as heated. Let remain until the fire is all out and the steel entirely cool—which will require several hours. It is therefore well done just prior to quitting time at night. Some gunsmiths use a piece of pipe in which to heat small steel articles for annealing, packing fine pulverized charcoal in around the pieces. Cleaning will always be advantageous. Put the pieces into the pipe, plugging the end with fire clay, and heat to a cherry-red. Then cover the fire, pipe and all, leaving it to cool as in the other case.

To Blue Steel—Polish the article to be blued, then place it upon a heated steel block and watch until the desired blue color appears. Remove and let cool, which will cause the color to remain permanently.

To Remove Blue Color from Steel—Immerse for a few minutes in a liquid composed of equal parts hydrochloric acid and oil of vitriol. Rinse in pure water and rub dry with chamois skin or some kind of soft cloth.

Test for Good Steels—Break the bar of steel and observe the grain. This, in good steel, will be fine and have a silvery look, with sometimes an exfoliated or layer-like appearance. One of the tests of steel is to make a cold chisel from the bar to be tested; when it is carefully tempered (be careful not to overheat), try it upon a wrought-iron or cold-drawn steel bar. The blows given will correctly tell its tenacity and capability of holding temper. Remember the temper you give it, and if it proves tough and serviceable, use it as a guide and temper other tools in like manner. Inferior steel is easily broken and the fracture presents a dull even appearance which may very appropriately be termed a "lifeless look."

Case-hardening—You will wish to do some simple case-hardening on the various parts of guns

such as guards, butt plates, screws, etc., and on different parts of the locks such as hammers, tumblers, triggers, and plates. I shall describe this process briefly. The cyanid of potassium bath can, of course, be used as given in Chapter XVI, Volume II, but the beginner will wish to experiment with different methods for experience until he is qualified and can perform the more complicated processes. When gun parts are received from the manufacturer or dealer in the white, such articles are only in a partially finished condition. The parts on cheap shotguns are invariably soft and these must be case-hardened.

The beginner will have a good subject to start on if he disassembles one of those double-barreled shotguns which are sold for \$20. These parts are only made of soft steel, and if not treated they soon wear and have to be repaired. Finish these parts with a fine file and fine emery cloth to a high polish, and when case-hardened and put together, all the working surfaces will be hard and infinitely more durable and reliable.

Why so many in the trade do not case-harden their work cannot very well be explained, unless they are ignorant of the process or do not care to be put to the trouble of doing it. Some gunsmiths, when such work is finished, heat it red-hot, smear it with prussiate of potash or cyanid of potassium, and while hot plunge it into cold water, letting it chill. This produces a superficially hardened surface that is not even "skin deep" and naturally will wear away rapidly.

If one examines a case-hardened piece of metal from an expert manufacturer, he will observe that its surface has a delicate grayish appearance and that in many places it is mottled with tints that are pleasing and beautiful. He will be further assured that this hardening is of such a depth that it will wear for a long time. As a fact, it will wear better than hardened steel. The condition of the material is that of a hardened steel surface stretched over the iron body of the work. It is stronger than steel, for it has the tenacity of iron at its interior. It has an advantage over steel, inasmuch as it may be bent when cold to a considerable degree, and when so hardened will not break as readily as steel. This elastic property is not retained in articles that may be case-hardened entirely through, for then they would be very brittle and easily broken; but by drawing them to the proper temper after hardening, in the same manner as a tool is drawn to temper, they may be of any hardness desired.

The easiest and perhaps the best way for one to case-harden gun work is to have a number of short pieces of common iron pipe such as will be

adapted to the size or quantity of the work, and have one end of these pieces securely plugged or closed. One way will be to heat the pipe and close by flattening the end with a hammer on the anvil. This is a "slouchy" way of doing it. A neater way would be to have pipe threads cut on the end and fit a cap such as is used to close the ends of pipe. Place the work in the pipe, packing it well with good fine bone dust such as is used by farmers for fertilizing land. Be careful to pack so that the different pieces of work will not touch each other. Stop the open end of the pipe with a cover, but in such a manner as to be readily opened. Place pipe and its contents in a good fire, letting it remain at a heat of about 1600 degrees Fahrenheit, one hour. Remove from the fire and quickly empty the contents of the pipe into a pail of cold water, tepid water, or oil, depending upon the purpose for which the parts are to be used. For ordinary purposes, clear cold water is satisfactory. The practise of allowing the pipe and its contents to become cool, and then reheating prior to quenching, is based on the old rule of hardening on a rising heat. This method gives much more satisfactory results than that of plunging the parts into a pail of cold water at the end of the case-hardening period.

Articles of malleable iron and cast-iron are as easily case-hardened as cold-drawn steel and machinery steel. A poor quality of steel is beautified by the operation as the metal absorbs the carbon in which it was formerly deficient.

Bone dust is the material most readily obtained for case-hardening and is clean and handy to use; but it will not produce the mottled tints that charred or burnt leather or horn will. The leather may be prepared by cutting up old shoes, putting them in an old pan over the fire and letting them heat until they are a charcoal that will crumble to pieces by using a little force. Grind the charcoal to a fine powder by pounding it in a mortar. Pack the work with the powder. Gun guards, straps, and long pieces of work will become shrunken by case-hardening, and it is best not to fit these pieces into the stock until after they are hardened. If it is desired to have a portion of the work left soft and the other parts hardened, cover the places to be left soft with a coating of moist clay; this will prevent the hardening material from coming in contact, thus prevent the absorption of carbon, and so it will harden when put in the cold water. Articles which are case-hardened will not rust so readily as those not so treated. If parts are quite thin and there is danger of cracking by sudden chilling, the water may be warmed a little or a film of oil may be spread on the water. This

will tend to prevent too sudden a contraction of the article while cooling.

If it is desired to have the work finished in colors or in the mottled tints seen on some kinds of case-hardened shotgun work, the surfaces of the work, before being put in the receptacles, must be nicely polished and then buffed or burnished. The higher the finish the more brilliant will be the colors.

In using prussiate of potash to case-harden, the potash must be finely powdered, the work heated and dipped in, or if the work is large, the potash must be spread over it. The work must be hot enough to fuse the potash, and if it becomes somewhat cold by removing from the fire, it must be reheated, removed quickly from the fire, and quenched in cold water.

In preparing for these various ways of case-hardening, the beginner will find it easy to collect such articles of animal origin as cow's horn, hoofs of animals, leather trimmings from shoe-repairing shops, and old cast-off belts or shoes. These he can burn in an old pan until sufficiently charred to admit of being easily pounded into a powder. He will then have material always ready at hand.

In earlier times, when guns were as much in use as agricultural or mechanical implements and there was a gunsmith's shop at almost every cross-road, there was a way of case-hardening much used that was simpler than the foregoing and yet quite effective. Scraps of old leather were cut from old boots and shoes, and these were tightly wrapped and tied around the piece of iron to be hardened, to the extent of several thicknesses. Around this was placed a layer of sand and salt mixed in equal proportions to a thickness of half an inch. The sand and salt were dampened with water to make them adhere. A layer of clay an inch in thickness was then worked around the whole, and the ball so made was exposed to a cherry-red heat long enough to consume the leather when it was dropped suddenly into the water. There is one more useful

method to "chill" or harden cast-iron. Make a solution by dissolving in ten gallons of rainwater the following:

1 peck common salt
 $\frac{1}{2}$ pint oil vitriol
 $\frac{1}{2}$ pound potassium nitrate
 $\frac{1}{4}$ pound cyanid potassium

Heat the iron to a cherry-red and plunge it at once into the cold solution. This makes cast-iron hard enough to cut glass; it is the method usually resorted to for hardening the cheap cast-iron cutters which were common at one time.

The foregoing methods and practises cover the needs of the mechanic but are hardly exhaustive. Heat treating is a branch of metallurgy which is intensely scientific and so is quite beyond the ability—and fortunately the needs—of the workman. You should and will take pride in the physical, mechanical, and chemical knowledge of the subject you are interested in, for it requires at least some special training and no little study and effort to bring about a state of efficiency. Nothing that pertains to gun work in general lies outside of these comparatively simple processes. I would add, however, this caution: Do not attempt those things which are beyond your ability. I would influence you to apply your experiments in other directions where failure does not carry vital consequences. In this we have in mind those parts of modern arms that have to bear the stresses of modern high-power ammunition. The receivers of bolt-action rifles and their bolts (in the Springfield, Krag, Winchester, Remington, and others) are made of special materials of known composition, and the heat treatment has been adjusted exactly to their requirements. To touch this temper, much more to attempt to restore it, is beyond the ability of any one not scientifically trained. I council and urge my readers not to experiment in this direction. One's eyesight, yes, even one's life, is endangered.

CHAPTER XX

Revolver and Pistol Repairs

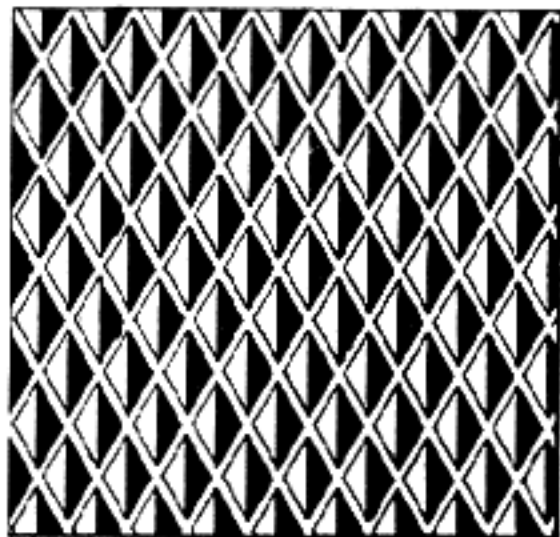

Revolver and Pistol Repairs

WE AMERICANS are especially blessed in this matter of handguns, both as regards quantity and quality, certainly the latter, for in no other country are the standards of manufacture of revolvers and pistols as high as in the United States. Not only in high mechanical perfection but also as regards excellence of design, constant improvement, and particularly in the development of new models and improved features do our manufacturers keep abreast of all competitors.

The last decade has been an especially prolific one with our shooters when it comes to new and improved revolvers and automatic pistols and the most discriminating handgun crank has little cause for complaint when he considers the many new and improved models recently brought out: Smith & Wesson with their embedded head cylinders and their heavier-framed and better heat-treated heavy calibered revolvers; Colt with their matted frames and non-reflecting surfaces, checkered triggers and grips, the readiness with which they chambered their most popular models to take all the better cartridges, and particularly the selection of fine, man-sized pistols and revolvers which they have chambered and adapted to shoot the increasingly popular .22-long rifle cartridge. Indeed, our rifle manufacturers could well emulate them in this last respect, and by so doing offer to our riflemen something better than the trifling, boy-sized .22 hunting rifles which they now produce.

Due to this splendid quality and superior workmanship of our manufacturers, our handgun troubles are comparatively few. In fact it is seldom that a pistol or revolver fails us through legitimate breakdown; generally the trouble is due to misuse, neglect, or the efforts of the owner to effect some change or improvement to his arm. This chapter will be written mainly for the benefit of this latter chap, the crank who is never satisfied with the things that be—as long as they be related to pistols and pistol-shooting matters. Many of the subjects applicable to pistols and revolvers, such as adjusting trigger pulls, bluing and browning parts, checkering of stocks, etc., are covered in other parts of these books under their respective heads; therefore this chapter will only deal with those special problems peculiar to handguns.

A revolver is a repeating pistol operating by means of a revolving cylinder. A pistol is a single-shot rifle of such size and shape that it can be aimed and fired with one hand. For this reason we classify the automatic as a pistol, since it also has a single barrel. In modern revolvers only the cylinder revolves, but in many of the obsolete arms the barrels revolved. The cylinders in modern arms are chambered to take from five to nine cartridges, six being the standard. The term "pistol" is applied rather indiscriminately by many to revolvers, automatic pistols, and the single-shot pistols; this is particularly the case in the average newspaper of today. Since the use of all three of these arms has become so popular, and the skill in shooting them has been developed to such a high degree by the target shooters of the day, there is a recognized difference in the use of these arms and in the skill developed in manipulating them.

Great credit is due the American manufacturers of handguns, particularly our two leading firms. The requirements for our national weapon are many and varied, and theirs has been an up-hill fight, increasingly hard of late years because of the fool anti-gun laws being passed by every police-ruled municipality. Prohibition, it seems, was admittedly a failure, but not firearms prohibition; let us do away with these weapons of destruction and by so doing place any and every law-abiding American citizen at the absolute mercy of armed crooks who admit of no law but the rule of intimidation. And it is but yesterday to a large portion of this country when the "six-gun" was the only law known in that section and every American went about with law, order, and justice always at his right side.

Revolver and automatic pistol repairs are rarely encountered with our best American arms; trouble is mostly experienced with the cheap arms produced here and abroad, and these require many minor repairs. European nations may lead in other firearms, particularly England and Germany, but not in handguns; altho some very good examples of automatics are produced in Germany. But the majority of foreign pistols and revolvers are cheap beyond comparison. Every week a surprising number of cheap arms which are worthless or far beyond redemption come into my shop for repairs,

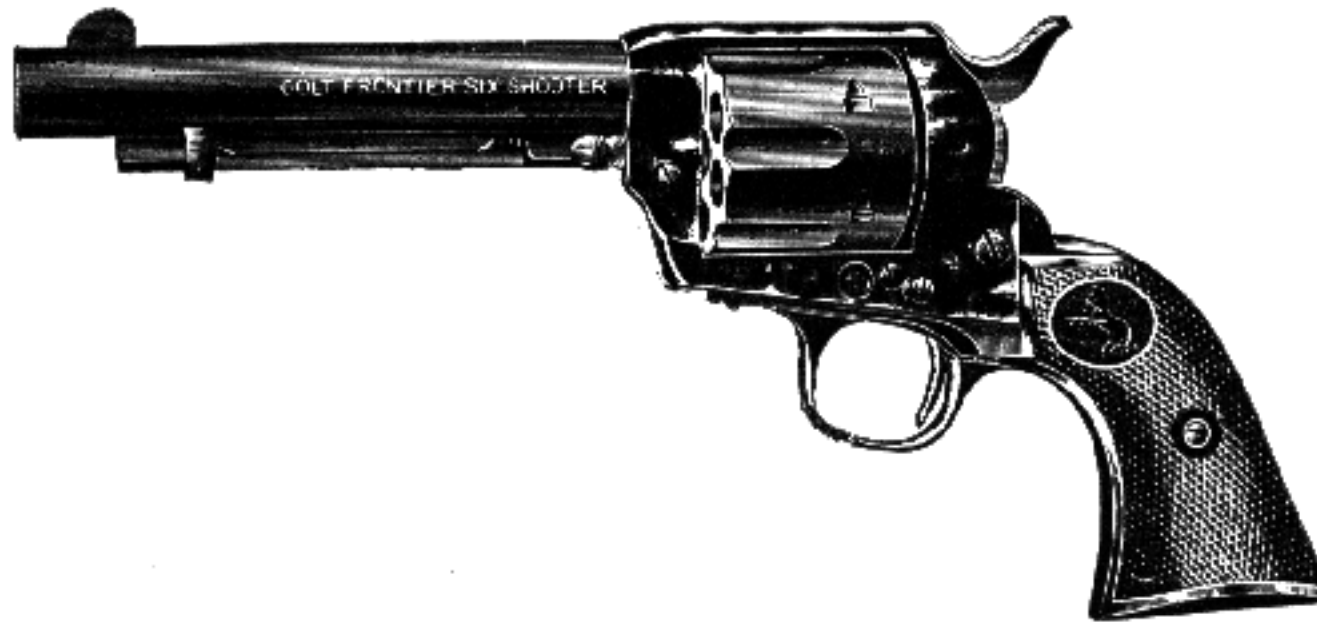

Fig. 125

The old peace-maker that brought law and order to our early frontier.
The Colt single-action revolver

and I have learned that it does not pay to bother with such weapons, for you will spend more time trying to get them in working order again than you can ever charge for. This is especially true of the Spanish handguns, and if I can avoid repairing these, I do. Actually, it is always best to treat these as experimental subjects on all occasions.

All our better grade of domestic arms reflect superior workmanship and manufacturing facilities, and it is always advisable to ship these back to the factory when any major repair or replacement is indicated. However, owing to the existing postal laws, this is an expense and inconvenience to a great majority of our pistol shooters; hence, if only a minor trouble exists it will pay to make the repair yourself. When shipping back any handgun it must be sent by express, such articles being now excluded from the mails.

The work done by the owner of our better class of revolvers and pistols usually consists of remodeling the hand grips, bettering the trigger pull, changing or correcting the sighting of the arm, remedying slight ejection or ignition troubles, and a possible bit of retouching the finish of a worn action or barrel. As far as the average gunsmith is concerned, the lid is off and he is liable to be called upon to fit a new barrel or cylinder just as quickly as to reassemble the latest model from Colt's which the proud but stupid owner took apart as soon as received "to see how it worked." Hence I must cover considerable ground in this short but important chapter.

New Grips — This is one operation which the amateur can work on to his heart's content and with slight likelihood of doing any damage to other parts of the gun. If you should spoil a grip over which you have spent two or three days' time—what's the difference? You can easily cut out another piece of walnut and begin all over again, for the experience gained will be beneficial in many

ways. Work of this type is essential to your future good marksmanship, as the feel and fit of the grip of a handgun is just as important as the stocking of a match rifle and a pair of properly fitted grips will gradually increase your scores on the target.

All scrap pieces from the better grades of gunstock blanks should be saved and this wood used for pistol grips. When available, select the dark pieces of Circassian, French, or Italian walnut. If nothing but American walnut is at hand, pick out those sections of root growth which have the closest grain and the finest figure. The soft sections of American walnut are worthless for grips, and much time and effort will be saved if the finest of European walnut is used; the amount required is small and the price will be little if anything. Beautiful burls may be selected and grips made which are unique in coloring and pattern, in addition to being a proper fit for the shooting hand.

The blanks should be sawed out much oversize all around and each pair should be gotten out from the same piece of wood, particularly if it is well figured. Saw the piece roughly to shape, but have it twice the required thickness; then split it with a fine-toothed saw and use the two halves "inside out," which will make the grain and "pattern" identical on each side of the grip.

The tools required for fitting consist of small carving chisels, a small rasp, and small half-round files. Also, forms will have to be cut out of hard wood to hold the grip in place in the vise. I have seen many a good job done at home with a small vise clamped to the table top.

If the dimensions and outlines of the new grip will be larger than the frame, the front and back straps must be inleted into the wood just half their depth on each grip. Follow the same general rules used in the inleting of rifle actions, and cut the outlines of the frame straight into the wood, using the wood-carving chisels—the small, sharp chisels are the ones required. Use mouse-like gnawing

cuts. Spot in the grips with lampblack, using very light coats on the frame. The two edges of the wood must meet in the center of the straps and each grip must have perfect contact with the other so that when the work is finished you will scarcely see the dividing line; otherwise when the two pieces come together you will see rather large cracks between them.

After the blanks are properly fitted to the straps, drill the holes for the stock screw and alinement pins, and counterbore for the escutcheons. It will not be advisable to remove and use the escutcheons from the standard grip you are replacing; better make new ones and also a new screw. The regular stock screw will not be long enough, and if used, it will be necessary to counterbore so deeply as to spoil the appearance of the job. Fit the new stock screw up tightly so there is no creep or give to the grips. With the blank now properly fitted to the frame, form the wood to the shape of the model you have decided upon, using the carving chisels and different shaped files. To arrive at the proper shape, clamp the barrel between the felt jaws of the vise and carefully work down the surplus wood. Be very careful that the files do not touch and mar the metal at any time, and when finished to the required form and outline, remove the grips from the frame and fasten them to a dummy block of wood by means of a small wood screw through the escutcheon screw holes. Now hold this block in the vise and do all that final touching up which was impossible while the grips were on the finished gun. They can be sanded down while on this dummy and you may wet the wood and raise its grain as is done for a rifle stock, a process described in the chapter on Modeling and Shaping. After this operation they may be finished by using any of the formulas given in the chapter on Giving the Stock Its Final Finish, and then checkered or carved as described in Chapter XIII.

Artistic skill may be exercised in various carvings or decorations. A strip of $\frac{1}{32}$, $\frac{3}{64}$ or $\frac{1}{16}$ inch silver may be fitted between each side of the frame and the wood, with the outer edges polished very highly. This gives a most beautiful contrast between the blued steel and the wood. These silver strips work equally well on either revolver or automatic pistol grips. Or a piece of sheet silver may be fitted to the bottom of the grip and then covered with a piece of buffalo horn and the latter rounded off in conventional lines; this "grip cap" is held in place by two small screws into each of the right- and left-hand grips, or by a center screw counter-sunk into the metal bottom strap after alinement pins have been inserted in a manner identical with the regular stock pins.

Grips may be made of materials other than fine woods; there is available buffalo horn, mother of pearl, ivory, walrus ivory, stag horn, cow horn, etc. The artistic student may wish to "crib" Charlie Russell's trade-mark that one sees in the corner of all his paintings, substituting his own initials for that "C.R." which centers on the steer's horns still intact. Or some very fine decorative work can be done by setting in various forms of ivory and buffalo-horn inlays as suggested in Chapter XIII.

The dyed-in-the-wool target crank may want to depart entirely from the conventional designs and model his grips to conform exactly, by allowing grooves for each finger and the thumb of his shooting hand. And here is really where plastic wood comes into use in gun work. The best method of arriving at this perfectly-hand-filling grip is first to make temporary grips of thin white pine or similar wood and then mould out the personal characteristics of the individual hand. To do this, spread a thick layer of plastic wood over the fitted panels, oil the hand slightly to prevent sticking, and firmly grasp the pistol butt in the exact position used in the act of firing. Take your proper stance and actually aim the gun at the target, arm extended as in firing; hold it there for a brief interval and then remove the gun from your hand without disturbing the rough mould, which should be in exact conformity to your hand and fingers. Carefully remove any surplus from the straps with a penknife and then clamp the barrel in a vise and let the mass dry and harden. The shape will remain.

Plastic wood may, after drying, be filed or sanded to any shape desired, or it may be changed until you have the desired form by adding to any point found lacking. Before going too far with the finishing of the plastic wood stock, take the gun out on the range and actually fire it at the target. Keep altering the shape until you have a perfect hold in the grip which suits you best. This actual shooting may show up points or faults not noticed when merely pointing the gun. After you have the grip exactly correct and to suit your fancy you have a model which may be copied in walnut or in any other material which you decide upon.

This model made from plastic wood may be heavily shellacked and castings made of it from aluminum, as this is an ideal metal for such purposes. Or you may wish grips which are unbreakable but of the standard shape on the gun; simply use the factory grips as a pattern, but first build up the under side $\frac{1}{32}$ inch by gluing on thin cardboard of that thickness. Grips thus cast from this pattern will be exact duplicates of the standard

stocks, even to the medallions and checkering. Any foundry specializing in aluminum castings should turn them out very smoothly, and all that is required is a good scratch-brushing to dull the appearance of the metal. If obtainable, a sand-blast finish is to be preferred. The checkering on these aluminum grips will never wear smooth as a wood grip will in time.

On most of the double-action revolvers the space back of the trigger guard permits the hand to slide up too far for a firm and steady hold. When fitting new grips it is possible to have the wood come forward to the guard and eliminate this opening, with a greatly improved grip as a result. Some shooters fill this in with plastic wood to suit their taste or make up a piece of cold-drawn steel as shown in Figure 126. The raised projection just

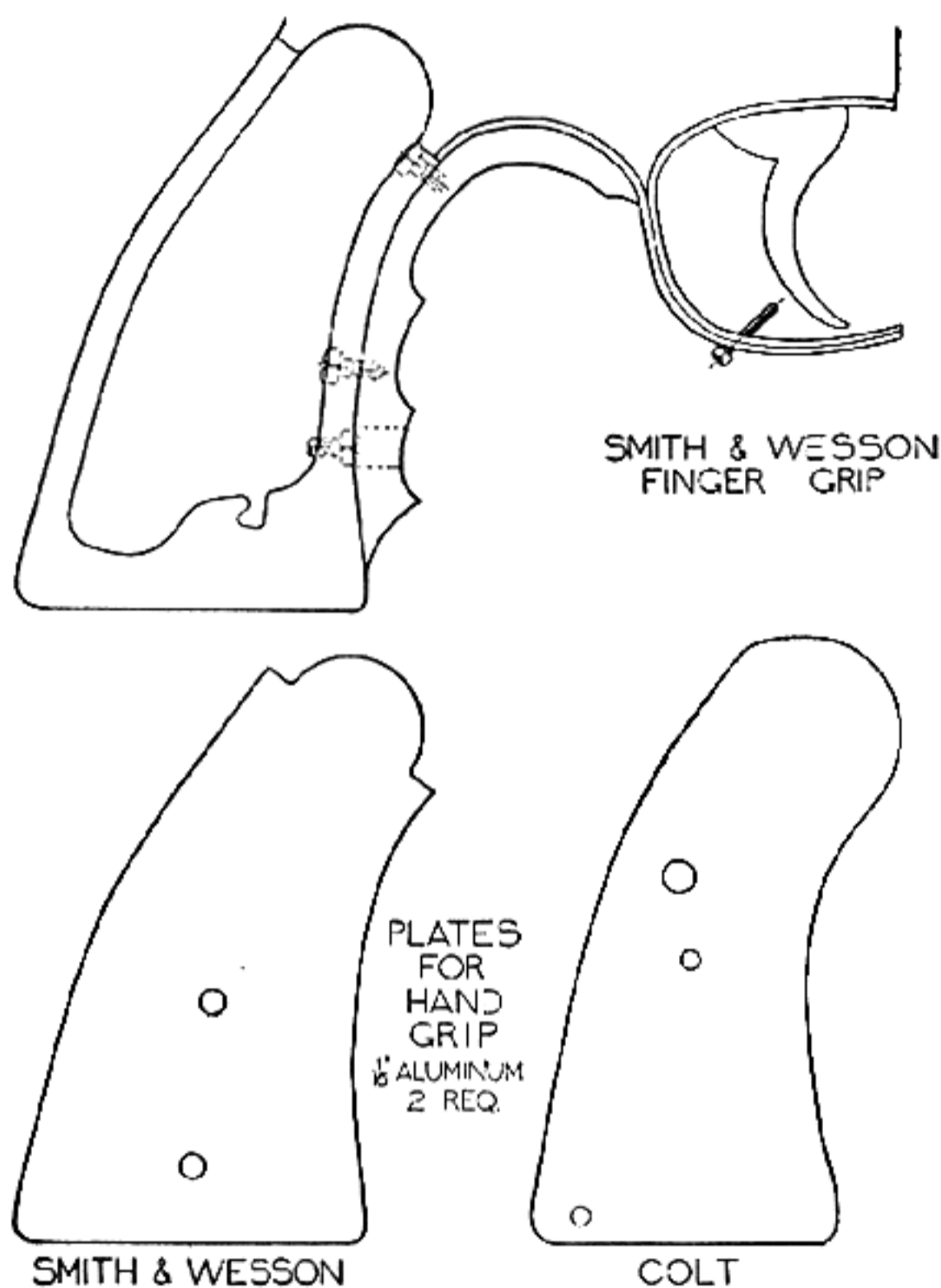

Fig. 126

Plates and finger grip used on target revolvers for better holding

fits in between the fingers while the top part fills out the space; it is screwed in place by two small screws set in through the frame from the inside. I have also filed out this space and dovetailed in a piece of cold-drawn steel, making the fit so it was scarcely noticeable and looking as tho it were part of the frame. This was also anchored in place by

an inside screw. There has recently been placed on the market a device to remedy this failing. It is supplied in varying sizes to fit all models.

Often a piece of $\frac{1}{16}$ -inch sheet aluminum may be placed and fitted under both grips to widen out the stock $\frac{1}{8}$ inch, which makes a great improvement over the standard grip for the man with a big hand, shown in Figure 126.

Sights — The factory sights on revolvers and pistols are made to suit the ideas of the average shooter and a great many persons take it for granted that the height of perfection has been reached in these "standard" sights. But you may be one who must have better sights for better results or else to suit your own peculiarities of holding or eyesight. The sights on these arms can be altered to suit any idea or person—provided that person has originality enough either to do the work of alteration or to express clearly his idea to another.

The exact use and purpose of the arm must be considered before the old sighting equipment is stripped off. If a revolver is to be carried in a holster and used for protective purposes, it must have sturdy, substantial sights which cannot be bent or knocked out of place; sights which will not in the slightest interfere with the rapid drawing of the arm in an emergency. Sharp corners and square edges are totally out of place here; what we want is plain, solid sights "low down" on the barrel, and with rounded outlines, beads, or tips. A gold-bead front sight is apt to be especially suitable under such conditions, particularly one with a sufficiently large bead. On a target arm the exact opposite is called for; here we want clear, square, black, sharp, clearly defined sights which will show up in strong contrast against the target, and which are capable of minute and positive movements. The target arm will always be handled carefully and we can use the finest of pin-head beads for a front sight if desired.

The last decade has witnessed a great improvement in the matter of standard sighting equipment on our better-grade American revolvers and automatic pistols, particularly on the target arms with movable sights. The principle is entirely different in our two leading makes—Colt and Smith & Wesson. The latter firm fit a fixed front sight on all their various models and have designed a flat rear sight which permits movement of the notch in two directions, allowing for both elevation and windage. The Colt Company fit a front sight on their target arms adjustable for elevation, but some ingenious person may design a more simple means of raising and lowering this sight and of locking it

in a more positive manner. Their rear sight is a simple sliding bar moving in a dovetail slot across the frame. Both firms cater to the prevailing fashion of the day in the matter of sighting combinations; namely, the "U" rear notch with bead front sight of various-dimensioned tips and the Patridge type of wide, square and sharp-edged front bar with a corresponding wide and square rear notch.

The sight bases on either of these revolvers allow one to substitute, in a simple manner, other commercial sights or those of his own manufacture which can be made from a sheet of steel of the proper thickness. Only a hack-saw and a set of needle files are required to construct any form you may wish. In the Smith & Wesson the substitution is extremely simple with either front sight or rear bar, altho the front sight is much harder to file out than the movable rear. The shooter can make and try out any number of combinations of various widths of the Patridge type of sight on a Smith & Wesson arm, the rear sight being especially easy to experiment with as it is but a plain, flat bar of metal. The Colt is a trifle more difficult, particularly the front sight with its threaded and pivoted arrangement.

It is a puzzle to many shooters why the sights of some of our target revolvers should be so high, and here is a place where the careful workman with a few needle files can work a much needed improvement and at the same time take a somewhat awkward appearance off one of his favorite arms.

An improvement can be effected in the standard-type revolvers with fixed sights which have the small "V" notch at the rear of the top strap. A dovetail can be filed out across the strap, placing it as far to the rear as thickness of metal will permit; then a lateral sliding bar can be tapped for a small set screw if desired, as the dovetail should be parallel, which will permit an accurate lateral movement of the sight notch for windage or "holding allowance." This method is especially applicable to the old Army model-.45 Colt revolver, various military automatics, and the .22-caliber single-shot pistols.

The use of a peep sight is not practical on the usual revolver or automatic pistol, as these arms must be held at arm's length when fired and this defeats the optical principles of the aperture sight. However, some of the older generation of pistol shooters will remember that fine little pocket arm of the '90's (1890)—the Stevens Diamond Model .22 pistol which came equipped with a small aperture rear sight and fine pin-head front bead. The conventional manner of shooting this gun was to fold the arms together in front of the face with the

pistol laid on the left biceps while the head leaned forward and rested on the right elbow and left hand; this brought the face up against the right hand with the eye right up to the aperture according to the best of peep-sight principles. Remarkably accurate shooting could be done in this manner, but I have not seen such a position used by the last generation. However, the use of a peep-sighted pistol is entirely possible under these circumstances with an arm whose recoil and power is not too great, and users of .22 single-shot pistols who care to try them with a peep sight can fit in a suitable rear and bead front sight.

The question of a suitable front-sight base often arises, due to the barrel being shortened or some arrangement being made whereby front sights may be changed readily. At times a fixed, slotted stud, similar to the Springfield rifle, can be made and fitted. The band or fixed stud may be made from steel tubing filed down to shape or it may be bored from solid metal and ground and filed to shape. This stud may be attached to the barrel by sweating or by being snugly fitted and then pinned with a cross-pin biting into both barrel and stud. A small headless screw can be used if set vertically through the thick part of the stud and just entering a shallow drill hole in the barrel. Either of these methods will lock the stud in place. The sight proper may be finished up in any shape desired, but before finishing it should be fitted temporarily into the slot and the arm fired on the target to determine correct height of front sight. After the correct height is determined it is finished to any desired shape of bead, carefully polished, blued, and fitted into the slot so it can be easily substituted for some other style of sight, or anchored permanently in place.

Should the front sight be of an awkward-looking height on a revolver barrel it is entirely possible and in good taste to fit a low, short ramp. In many cases this will add a most attractive look to the gun, but the height and particularly the length must be studied out and be in proper proportion to the length of barrel. A length of between 1 and 1½ inches will generally be right; on a target revolver this makes the outline very pleasing and if matted properly is an aid to good shooting. This ramp may be made with an encircling band and be sweated on the barrel in the same manner as on a rifle, or it may be made without such a band, but sweated in place with an additional small screw holding it fast; the solder and screw will make it a perfectly tight union. It could be silver-soldered in place, but I do not advise this operation except at the factory, where they have the proper equipment and experienced men; in too many instances this

has been tried by amateurs and resulted in a ruined barrel.

In Volume II we shall take up the manner and methods employed in the making of special sights for revolvers and pistols, which in itself comprises quite a lengthy chapter.

Sight Adjustments—A revolver or pistol as received from the factory will often group its shots to the right or left, or above or below the object aimed at; generally the misplacement is in a lateral direction. This is not due to carelessness in manufacture, as all quality handguns are targeted by skilled marksmen before leaving the factory, and must perform in an accurate and satisfactory manner before passing their rigid inspection. Such sighting discrepancies are generally due to the shooter's lack of training, peculiarity of hold, or incorrect method of trigger squeeze, generally the latter. The past generation has seen a great improvement as regards the proper sighting of arms by the factory; I can remember when the .38 double-action revolver was the official side arm of our armed forces and in those days you went out on the target range to find out which corner of the target frame was to be aimed at in order to place your bullet in the bull's eye. It is a long cry from that comparatively inaccurate and ineffective weapon to the accurately sighted and powerful .45 automatic of today.

Minor sight corrections are easily effected where the arm is equipped with adjustable sights, and you will invariably find such an arm with the rear sight slightly off center to compensate for some individual peculiarity of eyesight or holding on the part of the owner. But where the gun is a standard model with fixed sights, "as issued" according to the rules, the problem is by no means so simple or so readily corrected. Sometimes the front sight can be bent to one side a trifle to accommodate the deficiency, but often the shots will be grouped either too high or too low. If the latter, it is an easy matter to file down the front sight and make the necessary correction, but if the arm is shooting too high it will be necessary either to make a new front sight or to build up the old one.

To increase the height of a fixed front sight, file off $\frac{1}{16}$ inch and then place a $\frac{1}{32}$ -inch saw slot through the center running "fore and aft." File out a new blade to fit into this slot; the width of its top section should be a little greater than the width of the standing sight. The under-cut which is filed to fit into the saw slot must be a neat fit of the same depth as the slot, and when completed this is sweated into place. If due care is used in the operation, the joints are barely noticeable.

Shoot the revolver at the desired distance and gradually file down the surplus height until the gun shoots into the exact center of the aiming point. After this sighting in, finish off the sides neatly with a file and then reblue the entire blade.

If you find it necessary to bend the front sight to such an angle that it looks incongruous, bend it back into line again, fit a thin plate to the proper side of the sight and sweat it in place. This increases the width of the front sight and will cause the groups to move in the direction desired, even tho it is wider than the original sight. For example, suppose the shots are going to the right of the mark; accordingly, the plate is sweated to the right side of the front-sight blade. The additional amount of metal placed on that side necessitates swinging the muzzle to the left to center the mark with the wider front sight, and carries the group to the left also. File down the proper side of the widened blade until the gun is shooting in desired location and then polish and reblue. If you wish your group to be moved to the right, the plate should be sweated on the left side and you file off surplus metal from the right.

A change of this nature on the front sight may necessitate some alteration of the rear sight also. You may be able, by filing the rear notch slightly to one side or the other, to assist in the change of grouping caused by moving the front sight; or in case the desired change is slight, possibly the entire alteration can be effected through filing this rear notch to one side. Keep in mind that movements of the rear sight control the group location just as readily as the front sight, but the movement is just opposite, the shots moving to the same side as the notch. This simply means doing all the filing on one side of the notch, and maintaining the other side in its original form. Often it is desired to square out the bottom of a U-notch and change it to a wider Patridge type of sight; this can readily be done with a fine, square needle file having two safe edges.

With the .45 automatic it is easy to change the shot grouping laterally, as the rear sight may be moved in its slot. This is also a nice sight to interchange and experiment with.

Changing and Fitting New Barrels—This is a job I would advise sending to the factory unless you have the necessary tools to carry out such an operation properly; or at least the necessary tools to make the required fixtures to do the work, namely, a proper barrel clamp and wrench.

Usually when one attempts to remove a revolver barrel by holding it between wooden jaws in the vise and using a monkey or crescent wrench, the

result is a sprung frame. The backwoods method of winding a long rope around the barrel and turning it with a pick-ax handle seldom works here. This applies to most single- and double-action revolvers, particularly to those double-action revolvers in which the left side is cut away in order to receive the crane. Very few of the double-action frames are hardened, and it is an easy matter to spring such frames very badly unless a suitable wrench is made to encircle the cut-out on the left side and at the same time be made to the correct form for bearing against the right-hand side. The Frontier and Bisley model Colts have case-hardened, one-piece frames; therefore these are not as easily sprung as the divided double action; yet wrenches should be made for them as well.

If you do not wish to go to the trouble of making a solid wrench, as shown in Figure 127, two pieces

revolver be sure first to remove the small pin which goes through the frame and the top portion of the barrel threads and which holds the barrel rigidly in place.

To make a special cast-iron clamp the full length of the barrel requires a shaper or milling machine to form the block. It should have a two- or three-degree taper on the sides so that when it is placed in the vise the direct pressure will be directed against the top; thus the clamping pressure is solely upon the barrel. When the shaping of the outside is completed, the tapered hole is bored, and this should be to the same taper as the barrel. A clamp should be made for each different make of revolver, the sizes and tapers varying somewhat on different models and calibers. After the hole is bored out to fit the barrel intended, a $\frac{1}{8}$ -inch slitting saw is run through to within $\frac{3}{8}$

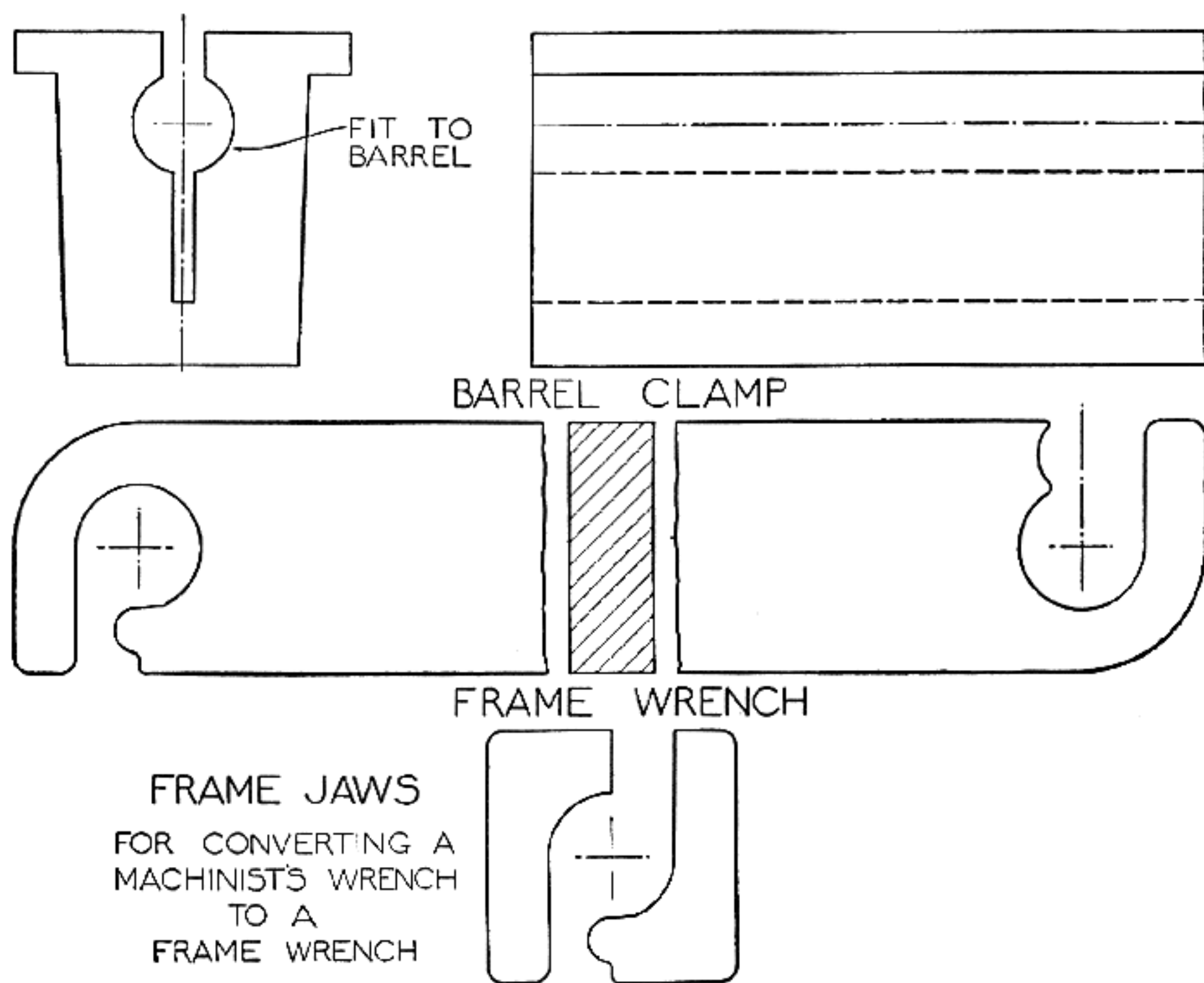

Fig. 127

Tools for removing and screwing in revolver barrels

of steel can be made to fit a crescent or monkey wrench. With these placed between the wrench jaws and tightened well against the frame, and the barrel clamped very tightly in the vise between the steel clamp as illustrated in Figure 87, Volume II, any barrel will break free from the frame. When removing the barrel from a Smith & Wesson

inch of the bottom. A larger slot is made at the top in order to allow the front sight to clear; and if for a Smith & Wesson, a much larger opening is bored at the breech end to allow for the swelled breech, and also the crane lock at the bottom, as this is integral.

If you are not in a position to make these special

parts necessary to remove or screw in barrels, it will be far better to send the gun back to the factory where they have the proper fixtures for holding, and appliances for removing old barrels. They can do this operation without any possibility of damage; and should any damage occur it will be repaired or the damaged parts replaced without any cost to the owner and without his knowledge.

Having removed the old barrel, clean out the threads in the frame with gasoline; a swab on the end of a stick or a small round brush will work well into the inside and clean it more thoroughly. Wash all grease out of the threads on the new barrel and apply a few drops of thin oil, say No. 1 sperm. Screw the new barrel into the frame by hand until the shoulder touches and then place it in the barrel clamp; tighten well in the vise and with the proper frame wrench pull it up into place, until the sight is at right angles with the square insides of the frame.

Generally it will be impossible to pull or turn the barrel to its final position at right angles with the frame. If so, back out the barrel and chuck it in the lathe, get it running perfectly true, and with a finely pointed side tool take a very fine cut off the shoulder of the barrel; again try and see if it can be fitted into the correct position. It may be necessary to take two or three such light cuts before it does come into proper alinement. Some gunsmiths try to pull a new barrel into place by extra effort, but this strains the threads; they should be set up very tight but this extreme is unnecessary.

If you do not have a lathe available to face off the shoulder on the barrel, it is in order to use a very fine file, and file off the face of the frame where the barrel shoulder meets. Prussian blue is used on the face of the barrel shoulder and spotted against the face of the seat of the frame; as the high spots are removed new spottings must be obtained. This is continued until the new barrel sets up tight and in perfect alinement. By properly spotting the barrel shoulder, a perfect bearing surface is obtained against the frame, which is a very important point in all revolvers.

The newly fitted barrel will now be found to extend too far out from the rear end of the frame to permit the cylinder to close and lock in firing position. This condition is corrected by holding the barrel, muzzle down, in a vertical position between the felt vise jaws, and with a fine pillar file dressing off the rear end of the barrel. Too much care cannot be used in doing this to secure a perfectly flat and square surface with a minimum of clearance which will permit the cylinder to clear and revolve properly. At this stage of the opera-

tion a very fine oilstone is used in connection with a feeler gauge; stone off the end of the barrel until a clearance of between 0.001 and 0.002 inch is reached with the feelers. Have the former the "go" gauge and the latter the "no go" at all segments of the barrel and you will be right. Revolve the cylinder and see that it will clearly pass every chamber position without binding; here is one of the fine adjustments in good revolvers.

After filing and stoning off the rear of the barrel for the correct clearance between it and the cylinder, a slight burr usually remains on the inside edge. This must be removed or the barrel will spit lead to some degree. To remove, take a short piece of round oilstone and grind an angle on its end in a circular radius; this can readily be done on the emery wheel. Make the angle slightly greater than the chamber on the rear of the barrel. Insert this in the chamber and twirl it around with the fingers, using only sufficient pressure to remove the burr and take the sharp edge off the end of the barrel. This operation removes the knife-edged burr, and a bullet will never be sheared as it is delivered into the barrel.

When a new barrel is fitted into a .22 automatic pistol, be very careful that the extractor slots come into proper alinement when the front sight is at its correct angle with the frame. Should they be slightly out of alinement when the sight is correctly fitted the barrel must be removed and its extractor slot widened out very slightly until the slide will close perfectly without any binding or friction against the extractor. A little Prussian blue will show the exact bearing if there is any binding against the cut-out.

Replacement of Parts—It does not pay to attempt to make small parts when they can be ordered so reasonably from the factory. Of course, if one wishes to gain the experience it is then advisable to make them, provided you have the broken part to use as a model. If not, better buy the new part, as some are so complicated in form and structure that you may spend many hours of labor before the correct shape is finally obtained and then you may have to make a number before having one which will work.

The old Colt single-action Peacemaker seems to be the worst offender among the revolvers in regard to broken parts, and I have more of these come in than any other model. This gun was designed some sixty years ago, at a time when our mechanical engineers were not as conversant with working stresses and steels as they are now—or with six-shooters either. Many of the working parts of this big gun are comparatively weak, particularly the

sear and bolt spring, hand and hand spring, end of trigger, and main spring. At times the base pin will wear at the notch or its catch become weak and permit the pin to slide forward from recoil. The owner of this arm who expects to shoot it much should have a few extra parts always on hand, particularly sear and bolt springs and hand springs. The firing pin on this arm is one of its strongest features and one seldom hears of this being broken. Despite all its faults owing to the weakness of the parts I have enumerated, this arm can usually be operated and functioned by hand provided the main spring is not the part broken.

Next in the line of cripples is the old double-action Colt Frontier model. There are still a great number of these around the country, stiff from disuse, and when picked up and operated they are usually found disabled through the breaking of some small part just as in the Army model. However, this double-action model has absolutely no appeal to the handgun crank of today, and since it is entirely obsolete repairs are only made to keep the old relic as a memory of the past.

The .38-caliber old-style double-action Colt military revolvers, which the government sold in such numbers, is an arm whose parts cause its owner much trouble; or rather, not so much the parts as the unusual manner in which they are assembled. Nearly all part trouble can be traced to owners who disassembled the arm and then did not get the hand spring back in its correct location; this lies in an odd position. After removing the side plate and having cleaned or repaired the gun they neglect to note how this spring is against the pin on the plate; they assemble it on the rear side of the pin, and upon trying out the action the spring is bent or broken as the hammer is drawn back. There is also much trouble to be expected with the bolt spring when you assemble the parts; it usually takes three hands to compress the rebound spring and place the rebound lever in position together with the bolt and spring. Broken main springs are common with this model but these can be replaced very easily.

There are so many automatic pistols on the market that I shall not attempt to enumerate them or the list of necessary replacement parts for the most common breaks. We shall disregard the cheaper foreign arms entirely. One finds few minor troubles on the better grade of automatic pistols. The three outstanding causes which I discover on the automatics brought in to me to repair are: badly neglected and rusted barrels; worn and bent magazines which permit the action to jam; and parts which have been ruined through the owner's ignorance in taking a drift punch and driving out some

part looking like a pin, possibly ruining both the part and the surrounding portion of the frame.

A common error made when trying to disassemble the Colt .32 and .380 pocket automatics is to push the retraction spring in against the plug with a tool of some kind and get it caught on the inside of the frame. If the plug cannot be entered again, the usual method is to saw the end off the receiver so that the spring may be removed through the opening made, or the plug made to enter the hole.

No matter how many sheets of instructions come with an arm, there are people who try to do it differently and in the end bring the gun in to some gunsmith to have it placed in condition again; at times it can be done and at times not without being sent back to the factory.

If an old magazine causes the pistol to jam, it is best to buy a new one, and send the arm back to the factory to have it properly fitted. It may be temporarily repaired by a slight bending of the magazine lips, but the sheet metal has probably lost its temper and will no longer hold to shape. At times a new follower can be made from a piece of steel and inserted, but in general magazine repairs are only temporary and it is not long before the fault is repeated.

The ejector on the .45 automatic goes bad at times and will throw the ejected cases into the shooter's face, and often jam the action at the same time. When this happens it is always best to buy and fit a new ejector rather than try to alter and repair the old one.

A rather common extraction trouble on the .22 Woodsman is caused by the owner's neglecting to clean the arm due to the use of some "cleanless" make of ammunition. The chamber becomes slightly rusted or pitted and the soft copper case expands when fired and sticks in the chamber. The remedy is to strip the action and polish out the chamber with a piece of fine emery cloth threaded on a piece of drill rod, the end of the rod having been slit with a hack-saw. Take a short piece of rod and revolve it with a hand drill, being especially careful not to enlarge the forward end of the chamber. Work the cloth back and forth as it revolves and do not go too far forward with it and cut the "lead." After that fault is remedied, see that the condition does not occur again; wipe out the chamber and give it a slight oiling occasionally.

Misfires — This serious offense can be traced to various faults, but in a number of instances it will be found to be due to the owner's misdirected efforts in having ground down the main spring in

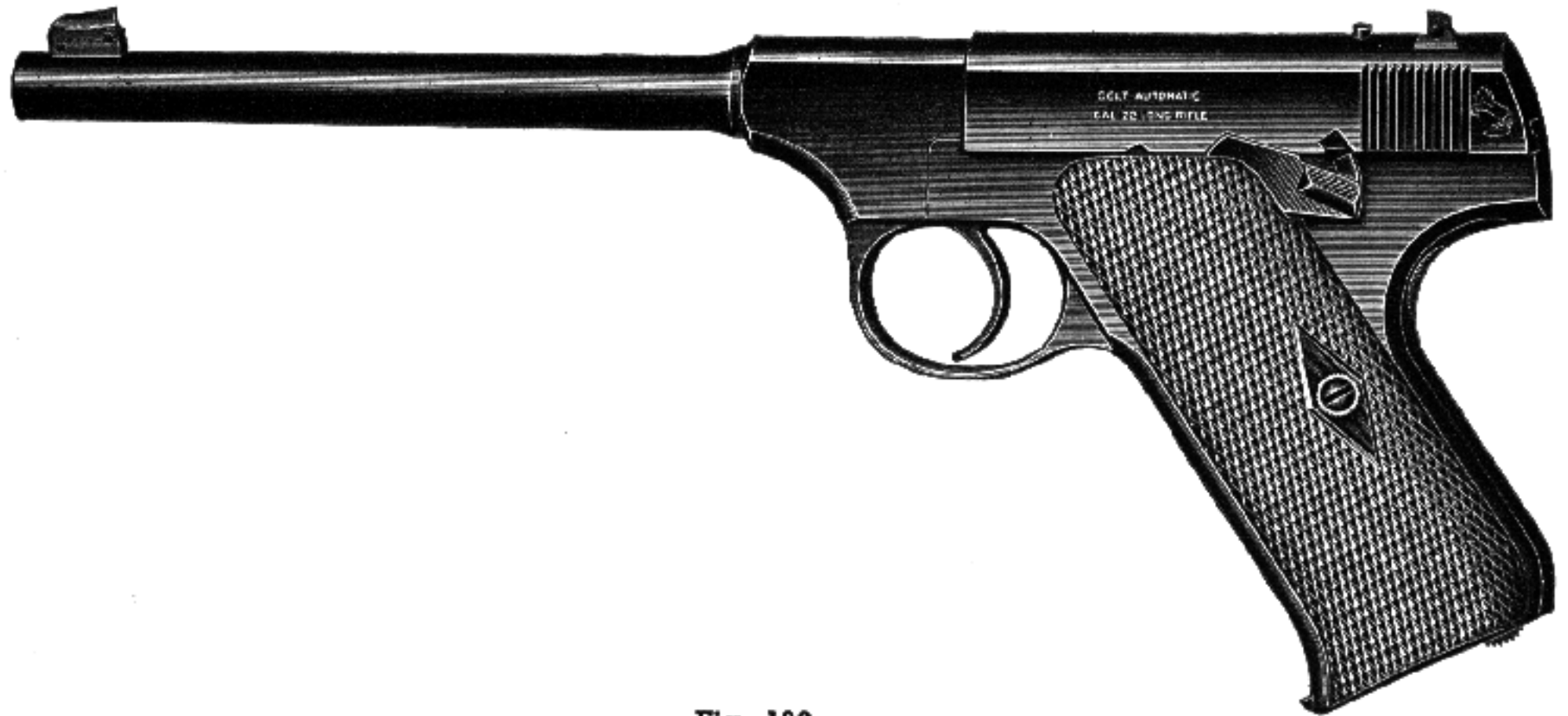

Fig. 128
Colt caliber .22 automatic. A very efficient weapon for the woodsman

order to make the revolver cock and fire more easily. When this is the cause, better send to the factory for a new main spring, or make one yourself from the best British spring steel as explained in the chapter on Spring-Making in Volume II. Most target shooters go to the extreme when they grind down the main spring on their pet target gun and then they wonder why so many misfires should occur with a standard arm and standard ammunition, never realizing that the fault is due to their own folly.

I wish to stress here this folly of weakening the main spring of a revolver in order to obtain a higher speed of fire. If there is any one occasion on which the shooter needs perfect ignition and certainty of fire from his revolver, it is when he is practising or working up speed in the firing of five or six shots against time. Quite a number of shooters derive much pleasure from such practise, and there exists a widespread fallacy that the weakening of the main spring is an essential and practical means towards the attaining of a higher rate of fire. On the contrary, it is an extreme source of danger. The trouble lies, not in a misfire but in a hang-fire. Imagine the results from delayed ignition in the case of a shooter who can throw out five shots in less than two seconds' time; the cylinder of his revolver might be half way around to the next chamber before the bullet leaves the case. Both main spring and trigger pull should be standard weight for this sort of shooting.

Sometimes in these revolvers where the firing pin is separate from the hammer, misfires will be in evidence as a result of wear or damage to the point of the pin. In many instances it may be worn too short. Purchase a new firing pin from the factory or make one from the finest of chisel steel, harden

it, and then draw the temper to a dark blue color. When fitting this new pin into the old bushing already in the frame, see that it has a free fit, not too tight, and operates freely. Too much care cannot be used in rounding up the profile of the point, as shown in Figure 129.

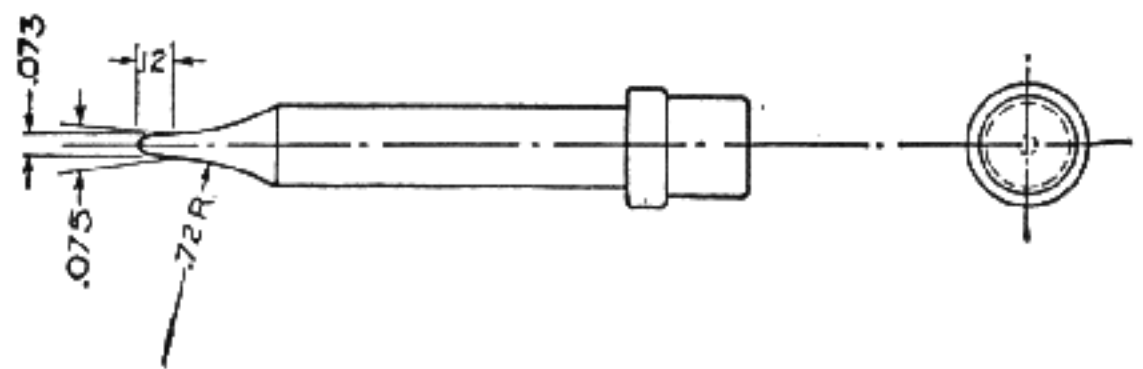

Fig. 129
Springfield striker or firing pin. Point measurements are used for all center-fire cartridges

It is surprising how many different ideas are encountered as to the pointing of new firing pins or strikers. The usual mistake made by the amateur is to give it a sharp point as on a wire nail or go to the opposite extreme and flatten the point. Instead, it should have a one, two, or three caliber radius on the end to give the correct indentation in the primer. The profile of a firing pin for a center-fire primer is of a different shape from that required for rim-fire ammunition. Study the profile of firing pins as they are received from the factory; place a magnifying glass on them and see how carefully they have been shaped up to a certain and proper radius. If you decide to make one yourself, be careful to have it free of all file marks; these aggravate the puncturing of the primer. The point should have a high polish without any roughness whatever, so that there will be a burnished surface to the indentation where it strikes the primer.

There are times when the firing pin is in perfect shape, but the hole through the frame of the revolver is worn too large. This will often cause misfires, as it permits the hammer nose (firing pin) to strike near the edge of the primer instead of in its center. To correct this defect when there is no bushing in the frame, drill and counterbore it out, tap the hole, and make a suitable bushing of good alloy steel. This means a job for a good mechanic. The new hole must be reamed to proper size, with the correct amount of clearance from the back. Should a new firing pin be necessary, the old hammer nose can be removed from the hammer by removing its rivet, and a new one either purchased or made.

The firing pins on automatics will occasionally break and it is advisable to have an extra one on hand. Because it is of a caliber used a great deal, the Colt Woodsman suffers such a mishap at times, and it is sometimes necessary to fit in the new pin to allow a trifle more "protrusion" or make the head a bit longer in order to have it function properly against the cartridge rim. If the new pin will not explode the cartridges correctly, I usually make the next one $\frac{1}{16}$ inch longer, and instead of filing off the under side slightly as the standard pins show, I only file the two sides slightly into a wedge-shaped face. By doing this I obtain a more complete blow with the full face of the pin instead of just the top segment as on the standard.

Misfires which occur in automatic pistols are at times due to the firing spring being too stiff. Many automatics are constructed in such a manner that the hammer does not have the firing pin give a direct and continuous blow, but are operated on the principle of a rebound. The firing pin is shorter than the channel in which it operates and the sharp blow of the hammer gives it momentum enough to travel forward and strike the primer with sufficient "percussion" to explode it; upon which the firing pin comes back and lies against the face of the hammer—not against the primer—a wise precaution which eliminates the possibility of an accidental discharge of the next cartridge thrown into the chamber by the automatic functioning of the action. This spring, therefore, must only be heavy enough to return the firing pin back to its normal position. On the earlier Browning automatics this firing pin was made of bronze, but it was surprising how well this soft metal held up under normal conditions. Therefore, when you first take apart a .45 automatic and happen to notice that its firing pin does not "reach through" like the conventional rifle or shotgun action, don't jump to the conclusion that it needs a new one.

The target shooter may go to the extreme in

skeletonizing the hammer of his pistol—in an effort to lighten it and speed up its lock time—and this will cause misfires. Best remedy is to plug those holes again, which is cheaper than a new hammer, or to try a stronger main spring, altho this last may change the pull of the gun and make it harder to cock.

Checkering Metal Parts — Most of the present-day models of revolvers and automatic pistols come with various parts of the arm checkered or grooved with straight-line corrugations; triggers, back straps, safety grip, etc. This not only improves the appearance of the gun but is of decided assistance in obtaining a firm grip of the hand to the butt and the forefinger to the trigger. It is only of recent years that these great advantages have been universally recognized; the handguns of a decade ago came with plain straps and triggers. However, the owner of one of these arms can readily do this checkering with a few very simple tools.

Steel parts may be checkered with a knife-edge needle file just as readily as one can checker wood with a checkering tool, except that greater care must be exercised to space the lines evenly, as we are unable to devise or use a satisfactory line spacer for work on metal. The eye is the only gauge used to space these lines evenly, but this is not as difficult as it may sound, after you once become accustomed to the use of the file. The general rule is to file in one line first, making it straight and laying it out in the direction that will show up the checkering best; at the same time make it very distinct so that succeeding lines may be similarly laid out and properly spaced. It is not necessary to polish the surface of the metal, as the clear silvery lines of the steel show up very clearly on the blued background.

Having all the lines correctly spaced in one direction, cut the cross lines in the same manner. After all the lines have been cut in with the knife-edged file, go over them with a three-square needle file several times and deepen the lines until the diamonds are well pointed. At this operation various little changes can be made with the three-square file to straighten the lines which are a little uneven and not parallel to the preceding line. The slight variations in spacing are more readily corrected in steel than wood, as these lines are only laid out and filed in to a given depth with the knife-edge file, and then the three-square file is used. This three-square file is easily controlled by bearing harder against one side or the other, and considerable change can be made in a line, as the first cut was made with a file that was very narrow

on the edge, whereas we are now working with a file having an angle of 30 degrees to a side.

If the amateur will practise a bit on a round piece of steel he will soon be able to produce file checkering almost as accurate as that done on wood. It is a hand operation throughout, and there is no tool available which will work better for the amateur than a file on the odd-shaped metal parts. The ability to do good file checkering will become a valuable asset to any amateur, as there is much of this work which can be done to advantage on most firearms.

As a rule, the curved portion of the trigger is about the most difficult part to checker with a file; it is not impossible, but it does require considerable patience to space the lines evenly over the doubly curved surface. Some triggers are hardened, and before these can be cut with the file it is necessary to anneal this curved part or "finger piece." A piece of wet cloth or waste is wrapped about the upper section of the trigger and the curve only is exposed to the flame of a Bunsen burner or alcohol lamp, heating the part enough to draw the temper until the file will cut it freely. Start your first cut near the upper part of the "finger piece," running the line down at a 45-degree angle, and continue to form these lines down to the trigger tip, holding parallel to the angle which the first line formed. All this is done with the knife-edge file and when you have reached the end, go back and commence the cross-lines. Cross-check at a satisfactory angle down to the first series and continue out to the tip. As you space the lines you will find it rather difficult to follow the curve and end the lines evenly to the edge of the trigger, but with a little practise this will come out all right, particularly after the first few lines have been made. Finishing the diamonds is done with the three-square needle file, and it is not necessary to carry this finishing too far. The checkering on a trigger need not be as fine nor as sharply pointed as the other surfaces, as one's finger will take hold quite readily. Actually, the shallow checkering looks much the better on this curved surface and it is not necessary to have the edges too sharp. Should an annoying sharpness or a wire edge remain when the job is completed, hold the checkering against a circular wire wheel on the grinding head, and this will remove the extreme sharpness.

Some shooters prefer a matted surface in place of this checkering. This is done with a matting punch and is a much simpler operation than checkering with a file. To many, this dull matted surface is much more attractive than the sharp diamonds. The operation of matting is explained in Chapter XXII.

Those professional jobs of checkering which we often see on metal surfaces are done with a graver in the hands of some skilled engraver. A close inspection of some of this work found on the finer shotguns will show it to be purely hand work, and in many instances it is a very fine design, the checkering sunk below the surface with a neat border around it. I have never been able to accomplish what you would call perfect work with one of these gravers, and I cannot advise the beginner to attempt its use unless he wishes to go in for the very finest work and is prepared to sacrifice many long hours of patient labor in attempting to master its handling. Where it is possible to roughen the surface by matting, it will be much better for the beginner to follow this method and to finish out his work with a border of suitable design and execution.

Refinishing — After completing the checkering or matting, or the repairs on some exposed part, it will be necessary to reblue some section or possibly the entire arm. The necessary instructions for this will be found in Chapter XVI, Volume II. Often one will obtain a nickel-plated revolver with all finish gone, but these can not be blued, as the bluing solution will never take effect once the metal has been nickel plated. Nickel penetrates the pores of steel so deeply that it resists all efforts to remove it completely by any polishing operation. The best policy will be to have the arm renickeled or else chrome plated. My advice would be to have it black-nickeled if possible, as I consider this treatment better than any similar process; the color is very pleasing and the method gives a finish which is rust-preventive to a decided degree.

Hammer Alterations — The many weird and conflicting stories told of how the bad men of the Old West "fanned" the hammers of their six-guns has resulted in the desire of many of the two-gun sheiks of this day and generation to try out this foolish and dangerous stunt. After they have doctored up their Peacemaker in accordance with some of the current suggestions it is a most dangerous weapon in the hands of the average citizen.

I have discontinued making any hammer alterations of this nature, except where the user of the single-action Colt desires the hammer spur lowered a trifle in order to call his shots better. The last time I made the change above referred to, the customer not only shot himself through the side of the stomach, but the heavy .45 slug, after passing through him, lodged in the elbow of a friend standing nearby, causing the latter to lose the use of that arm for life. It is not at all unusual for the owner

of one of these doctored-up "slip hammer" guns to discharge it accidentally as it leaves the holster.

The Colt single-action Army model is the only revolver which will operate by tying back or removing the trigger and then "fanning" the hammer. This is because the hand which operates the cylinder is connected to the hammer; on a double-action gun it is operated by the trigger, and when we tie back this trigger we are unable to rotate the cylinder. Quite a few of the drawing-room cowboys who recommend this method of shooting are unaware of the fact that a double-action gun cannot be "fanned."

However, many shooters do object to the high spur on the hammer of the single-action Colt. A definite and helpful change may be made by heating and bending down this spur. To do this, first remove the hammer, drive out the drift pin which holds the firing pin in place, and then drive the firing pin out from the rear. Clamp the hammer very firmly between the copper jaws of the vise, exposing nothing but the spur above the jaws. With an acetylene or blow torch, heat this spur to a red heat, up to where it joins the body of the hammer. With a round piece of copper rod as a drift, gradually tap the spur down to the desired position. When cool, the spur can be finished and then polished. After polishing, the spur is rechecked and the hammer should then be re-case-hardened as explained in Chapter XVI, Volume II. Be very careful to have the hammer properly and tightly clamped in the vise and only bend down the spur; if the body of the hammer is bent in the slightest the firing pin will no longer strike center, and it is a very difficult operation to try to bend the neck of the hammer back again so the firing pin will center properly once it is out of place. When the hammer spur is altered in this manner the line of sight is not obstructed, except momentarily by the nose of the hammer in falling; and if desired, a considerable amount of metal can be filed from the top of the hammer, which will eliminate even this objection.

Loose Screws — When a single-action Colt comes in for repairs the owner often asks us to tighten up all screws which have worked loose from vibration and then fix them so they will not come loose again. The only positive manner in which this can be done is to drill and tap in smaller screw threads alongside the faulty screw heads, and place small anchoring screws in there. Use small fillister-headed screws and place them in the manner seen in some rifles and all automatic shotguns; then it will be impossible for the larger screws to turn loose. We cannot rust or tin in these loose screws,

because it is only a question of time before the gun must again be taken apart to change some broken part.

Changing Cylinders — Many owners of these Model 1917 Colt and Smith & Wesson war-time revolvers wish the cylinders replaced with ones taking the old .45 Colt cartridge. It seems to be a widespread idea that this change is easily made, but after the owners have purchased the new cylinder and tried to fit it they discover that the substitution is not as easy, or as cheaply made, as they were led to believe.

There is quite a difference between the Colt New Service .45 and the Colt Model 1917 double-action revolvers. The Model 1917 was made on the New Service frame, but to the thickness of the head of the .45 automatic cartridge was added the thickness of the steel clips, making a much greater "rim" thickness than found on the old .45 Colt cartridge head. The cylinder and side plate were both changed in order to accommodate the Model 1911 Automatic cartridge; on the New Service frame the swung-out cylinder is held in place by a raised surface. In the 1917 Model this raised surface was relocated in order to take care of the shorter cylinder; therefore in order to interchange cylinders it is also necessary to interchange side plates. Such work requires much fitting, involving both side plate and crane; and each crane is also fitted individually.

On the Smith & Wesson Model 1917 they used their .44 caliber frame, and made up a new cylinder and barrel suitable for use with the clips. It is not remunerative to alter this arm, for by the time all the necessary new parts are ordered and the work is done, a new revolver could be purchased for less money.

And in the end all this changing of cylinders is impractical for the reason that the Model 1911 Automatic cartridge is equal in ballistics to the .45 Colt cartridge when loaded with smokeless powder. If the owners of these Model 1917 revolvers do not like to use the Model 1911 rimless cartridges there are available special rimmed cases which eliminate the necessity of using the steel clips.

Odd Alterations — I receive frequent calls to change many hand-guns for other than the standard cartridge originally intended to be used; alterations which no arms company will undertake or recommend. The nature of these alterations often calls for extensive experimental work, and special tools and reamers must be made to accomplish the undertaking. Alterations such as boring out the single-action Colt and other .45-caliber revolvers to use

shot cartridges; rechambering different arms to take the .22 Hornet cartridge, and bushing cylinders and relining barrels to adapt the .22-long rifle cartridge to the larger caliber arm. We cannot say that it is impossible to do such work, but there is really only one man in a thousand who is willing to pay a fair price for the work involved. If the shooter has available the proper equipment he can readily carry out such ideas for himself, but he must possess an extensive mechanical knowledge and will find various machine tools required to work out the many new ideas which will continually be placed before him by others. I shall give here only a few ideas which can be carried out without going into too many details.

Shot Revolvers—Many owners of .45 revolvers wish to have them changed to shoot shot shells and will load their own ammunition for such a purpose. The arm modified is the Colt single-action revolver bored smooth by reaming out the rifling in the barrel. The .45 is not the most suitable caliber to use, as it is necessary to ream out this barrel a bit too large to give a satisfactory pattern. A .44 arm should be selected, and the cylinders reamed to take the .45 Colt cartridge. A barrel length of $7\frac{1}{2}$ inches will give the best results after being reamed to 0.450 inch and the muzzle given a slight choke of at least the length of the shot column when in the case. By reaming out the rifling from a .44 barrel the increase in size is just about right for the choke necessary when the main bore is reamed out to 0.450 or 0.452 inch.

To do this reaming operation properly, three reamers should be made; one roughing reamer, made with spiral flutes, to remove the rifling from the barrel; one finishing reamer, which can be made with straight flutes—this also has the reduction on the end to give the required choke at the muzzle; and one chambering reamer for the cylinder, made straight with the required cone on its end to ream ahead of the chamber. There must be a certain reduction in the front end (or "lead") of the cylinder chambers in order that the shot charge may be carried properly into the barrel. The diameter of the .45 Colt case is 0.471 inch, and 0.002 inch must be allowed for free and easy extraction of the fired case, with an additional 0.002 inch taper to the rear, which makes this rear portion of each chamber 0.004 inch larger than the mouth of the unfired shell. In Volume II you will find correct methods described for making all these types of reamers, and when they are made as described, a very fine job of reaming can be done with them.

The necessary reaming operations are done in a lathe, and in order to obtain the best results the

reamers are pulled through the barrel from the breech end. Use a good grade of lard oil as a lubricant, and keep the roughing reamer well lubricated so that the bore will not have torn places and rings so deep the finishing reamer will not remove them. After the roughing reamer is used, the finishing reamer follows, being pulled through in the same manner. Have this marked so that it will not run in too deep and spoil the choke; the desired choke can be given after this mark is reached. Run the lathe at a moderate rate of speed for all the reaming operations on the bore and choke; that is, run the lathe with the back gears in and have the barrel chucked perfectly true.

The reaming of the cylinder should also be done in the lathe, but this can also be done by hand if considerable care is exercised. The barrel-finishing reamer is first passed through each chamber in order to have the chamber "lead" the exact size of the bore. Then the chambering reamer is used with the ejector web in place in the cylinder. An accurate stop should be made and set so that the depth of each chamber will be the same. Plenty of lard oil should be used to lubricate.

After the reaming operations are completed, the lapping of the bore and of each chamber in the cylinder is in order. This operation is thoroughly explained in Chapter XXV, Volume II. Shot is easily affected at the choke in a short-barreled gun and it is necessary that the muzzles of these pistol barrels be finished off straight and square instead of having the crown seen on all revolver barrels. It is best to trim this off square in the lathe while you have it out of the frame instead of trying to do it by hand with a file and with the guidance of your eye. The lathe operation will assure its being square and true.

The breech end of the bore must be chamfered or given a slight taper so that the shot charge will enter the barrel evenly, even tho the cylinder should be out of line the least bit. If you do not have a tapered reamer for this operation, chuck the barrel perfectly true and turn out the chamfer with a small boring tool, by means of the compound rest set over at an angle. The greatest length of this chamfer should not be more than one-fourth inch and it need only be 0.010 inch larger than the bore at the part in front of the chamber. While the barrel is still in the chuck, polish this taper with fine emery and crocus cloth. Having all this completed, go over the action and place it in perfect condition, screw the barrel back into the frame, and we are ready to proof-fire the gun.

In the proof-firing, it is not necessary to set the barrel in the frame very tight; catch it between the felt jaws of the vise and set it up tight against

the shoulder with the pressure of your hands. The sight may be a little off to one side, but the main object now is to see if the patterns obtained by the choke are sufficient.

Pattern the revolver at 10, 15 and 25 yards for a series of exact results. If the patterns obtained are too small it will be necessary to lap the muzzle choke a little larger; but if the patterns are too large a special lap must be made of an oval form, constructed so that it is expandable, which makes it possible to enlarge the inside of our choke without touching either front or rear. The chapter in Volume II on "Shotgun Repairs" describes the proper method.

It may require from three to six trials and alterations before a pattern is obtained that will meet your expectations. At the same time experiment with various loads of powder and sizes of shot until the best possible combination is reached. After you are satisfied with the pattern, set the barrel properly and tightly in the frame and bring the impact of the pattern where you wish it to shoot on the paper target; this is obtained by the adjustment of sights as previously described.

I once made a pair of these .45 shot revolvers for two young men who toured the different States and gave exhibitions of their shooting skill on glass balls thrown into the air. They realized well above their expenses out of the trip and led the audience to believe they were using the regular ball ammunition for all this aerial work. The account of some of their experiences was rather humorous, especially when some fraternal brother's curiosity would get the best of him and he would insist that the boys shoot one of his pet handguns. Certain sections of the country were easy to work with this racket, but some parts were not so good.

Relining Revolvers — To reline the large-caliber revolvers and chamber them to take the .22-long rifle ammunition or to use the .22 Hornet, .25/20 and similar cartridges, requires not only the relining of the barrel but the bushing and chambering of each chamber in the cylinder as well. The relining of the barrel is not much of an operation provided you have the necessary tools and equipment to do the job, but the sweating of the bushings into the cylinder calls for a considerable amount of skilled work. Not only that, but you are also obliged to make and fit a new ejector and a cylinder ratchet. When the change is made to adopt a rim-fire case like the .22-long rifle, the firing pin will also probably have to be changed, and this alone requires some close engineering. These changes are not impossible, but in a great many instances they are just not practical. With

the splendid selection of large-framed .22 rim-fire revolvers and automatic pistols now available there is little need for any shooter to transform any handgun to take this excellent cartridge.

Single-Shot Pistols — Very often it is possible to pick up some of the famous old single-shot pistols of a generation ago that were made by the J. Stevens Arms and Tool Company; the Lord, Conlin or Gould models or the little Diamond model. Invariably they will be rusted out in the bore, possibly the action is a bit shaky and the sights missing.

About the only thing we can do with these arms today is to reline the barrel to its original caliber and place the sights back in proper condition. These arms were made in a day when the velocity of the long rifle cartridge was about 900 feet and it was loaded with black powder. I would not advise using many of the present Hi-Speed .22 cartridges in such an action. Then the round and thin grip on these pistols is a hard one to alter or to build up properly according to our present-day tastes. Better place the old relic in first-class condition and keep it in the collection as a memento of the wonderful scores which it made in its day.

The little Diamond model is an exception as regards fitting with a suitable and proper grip; it is easy to fit this with an entirely practical "man-sized" grip, and one then has a most accurate and handy light-weight pocket pistol in .22 caliber, provided the ammunition used is not too powerful for the arm.

The average gunsmith receives very little single-shot pistol work today, other than the usual slight changes in sights, trigger pull or relining. However, once in a while some one shows up who wants a pistol rechambered and bored to take a different and far more powerful cartridge—say the .22 Hornet, or the .25/20. The old Remington single-shot navy pistol of .50 caliber is about the best basis for this sort of work. Figure 130 illustrates one made into a Hornet. Here is one of the safest actions known, and an easy one to work on. All attempts to produce a discharge from this arm when the action is not properly closed will fail. Their unusual strength and weight make these guns desirable for heavy charges and experimental cartridges; as a matter of fact, they will stand a much heavier charge or cartridge than may be fired from one hand with comfort. So, when the customer shows up who is insistent on some peculiar conversion job to be attempted on a modern revolver, talk him out of the idea or at least have him try it out first on one of these old .50 caliber pistols.

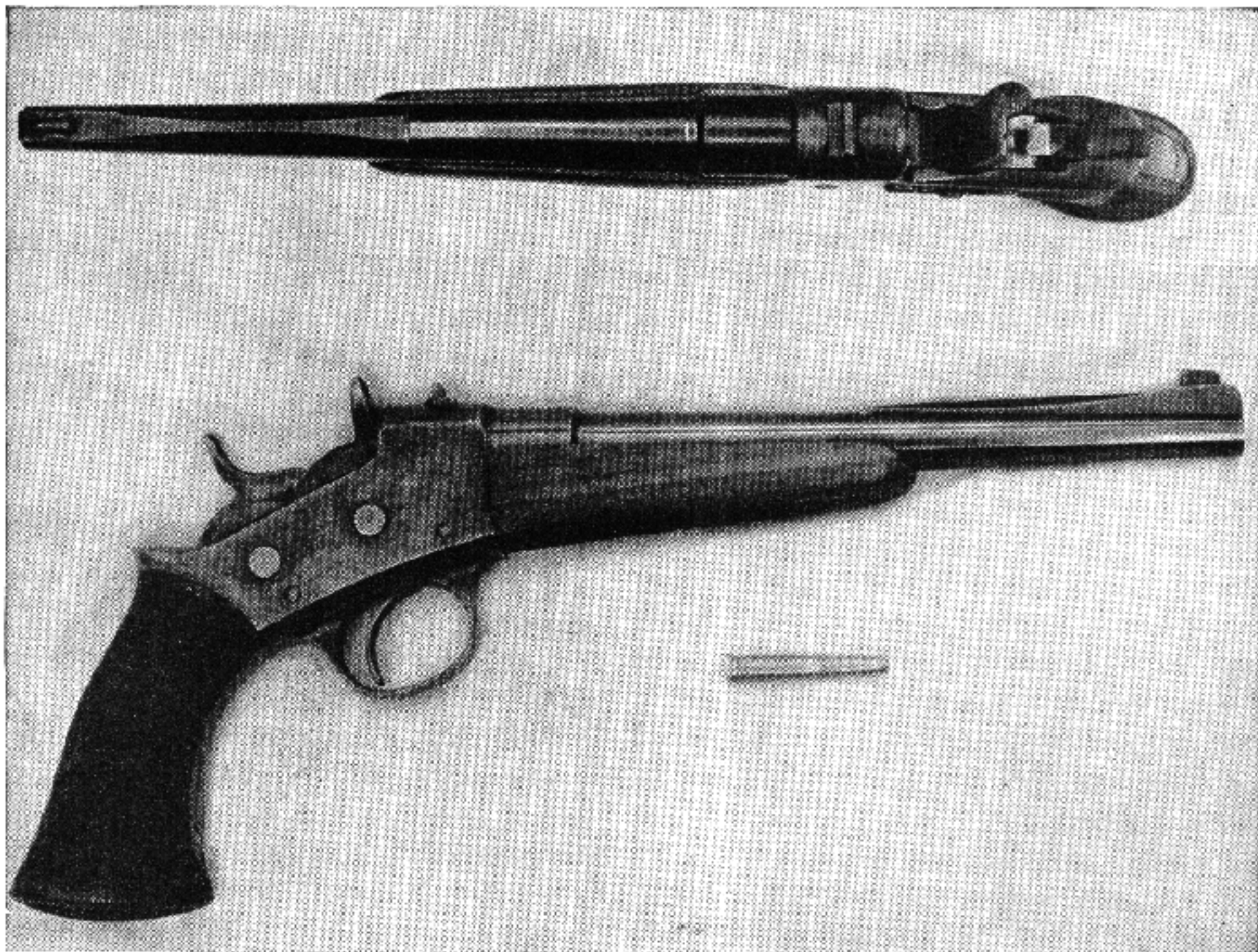

Fig. 130

Caliber .22 Hornet made on a Remington caliber .50 pistol action. Remarkable accuracy resulted from this combination

Trigger Stop Screw — Here is a minor alteration which may be made in revolvers and prove a great help to target shots. When a double-action gun is used in the conventional single-action manner and the hammer cocked for each shot it will be found that when the trigger “breaks” from the hammer notch, there is a slight back action sufficient to throw out the aim perceptibly. This back action of the trigger may be prevented by placing a small stop screw through the trigger guard from the rear, and adjusting it so that when the hammer falls, the trigger is at the limit of its travel to the rear. When fitting this screw, the threaded hole should be slightly tapered so the screw will fit very tightly. Use a 3 x 56 headless screw, and have it just long enough so that when properly adjusted it will come flush with the rear of the guard; then it will never interfere with or skin the knuckles. Figure 126 shows the idea properly.

General Hints — After you have cleaned or repaired a handgun, be careful how you lubricate the working parts. Use only No. 1 sperm oil for this purpose, and if you have used any other oil or solvent designed for cleaning the bore and chambers, see that it is carefully wiped off the mechanism. Too much lubricating oil is dangerous in the

mechanism of a revolver or automatic pistol; it may gum up—or in cold weather will freeze—and render it impossible to fire the arm without first “working off” the stiffness by snapping the action a few times.

Keep the hammer free of rust under the spur, and also keep rust from around and on the nose of the firing pin. Keep oil on these parts.

In dismounting the crane and cylinder from the frame, slack but do not turn out crane-lock screw, for it is possible that the crane lock will be lost-together with the screw. Do not try to unscrew the ejector or ratchet off the ejector rod in order to clean them. If any rust has collected between the rod and its spring, wash well with some light powder solvent, allow to stand for about 30 minutes, and then oil with light sperm oil.

Do not try to dismount an automatic pistol with a hammer and set of drift punches, for all parts of these arms can easily be dismounted (generally by hand) if instructions are followed.

If the double-action pull of a revolver is heavy, examine the end of the crane, strut, ratchet, etc., for burrs raised by a hard trigger or other causes. If burrs are found, remove them with a needle file. On a Smith & Wesson revolver it is possible to overcome a heavy double pull by reducing the re-

bound spring. To test the free working of trigger, hand and rebound lever, pull off at double pull, then let the trigger move forward slowly and pull back again before heel of the trigger engages hammer strut. If a rub is felt, remove plate and examine parts mentioned.

To test free working of hammer and strength of main spring, hold trigger back and work hammer with the thumb.

Keep rebound levers clean and free of rust, especially where end of rebound springs bear.

Always keep the strain screw tightened on a revolver. This strain screw is set to bear upon the main spring. If you wish to practise by snapping the arm—"dry shooting" they now term it—you can relieve this screw just so the hammer has a good, sharp fall, but not as hard as when the strain screw is properly set. One turn back will usually lighten it sufficiently for "dry" target practise.

Inspection of Handguns—Every so often, these days, I am approached by some friend or acquaintance with a hearty handclasp and the question: "Chap wants to sell me this six-shooter, is it all right?" The subject handed over for inspection and comment may range from an old Army model Colt single-action offered at five bucks, to a recent .45 Automatic with the prospective purchaser considerably excited over the "United States Property" stamping on its side.

As the shooter of any technical standing whatever has had this same experience happen to him, I am outlining herewith a rather extensive process of inspection which will readily indicate the exact condition of most handguns which may be presented for such opinion and decision.

This program is offered with the qualifying statement that it will undoubtedly prove a waste of time to employ the procedure when purchasing a new handgun of any of the leading American makes; in fact, the quickest method I know of by which the correct tolerances such as I have outlined can clearly be gotten to mind, will be to examine a new Colt "Shooting Master" or a Smith & Wesson "K-22." The tests I enumerate should prove of most value in instances where a supply of obsolete models is available, and careful selection from the lot is possible.

How to Select a Good Revolver—First, clean out the bore and chambers, and examine their condition in a good light. The bore should be bright throughout its entire length, with no pit marks, and the edges of the lands should be clear and sharp. There should be no dents in the muzzle nor should the latter be "belled" through improper

use of a cleaning rod. Each chamber of the cylinder should be clean and free of rust spots and pittings, and there should be no visible scratches which might cause faulty extraction. In the case of a .22, look closely and see that the "lead" has not been eroded unduly through the excessive use of .22 shorts.

Cock the hammer and hold the gun up sideways to the light while you examine the clearance between face of cylinder and rear end of barrel. There should be a minimum of light showing, and this clearance should remain the same with each chamber as the cylinder is revolved. The end of the barrel should be square and true from both sides. There should be no appreciable play back and forth when the cylinder is worked lengthways with the fingers.

Cock the hammer and examine the sideways play when cylinder is locked in position for firing. This is a most important point with any accurate-shooting revolver, and the play here should be very slight. Also, it should be the same with each chamber; cock and try by hand every chamber in the cylinder with hammer *cocked*, as there may be appreciable play when the hammer is down and yet none when it is raised.

Swing out the cylinder and test for rigidity; neither cylinder nor crane should show loose play. Slide ejector rod back and forth to test its fit and working qualities; it should slide back freely and be returned to place readily by its spring. Examine closely the ratchet on end of ejector rod; this should have clean, sharp edges and not be worn or burred to any extent. The cylinder stop in bottom of frame should still have clean, sharp edges and be of full width (not worn wedge-shaped); it should also work freely and positively; depress it with the forefinger a few times and see that its spring still has "life."

With the cylinder swung out, snap the hammer, and by holding the trigger down, test firing pin for protrusion; it should project sufficiently to explode the primer. Notice for wear or corroding away of the firing-pin hole; this should not be enlarged to any extent. Notice pawl or dog which rotates cylinder; this should have no loose play and should not be worn away too much on upper end, but should rotate each chamber completely to its locked position. If chambered for the .22 rim-fire cartridge, examine outer rim of cylinder under where firing pin or hammer nose rests; this should not be burred or dented to any extent.

Cock hammer and notice condition of loose hammer nose; this should be clean, not corroded away any, and must have considerable play. The cavity into which it fits should not be rusted or eaten

away with primer corrosion. In the case of a revolver having separate firing pin, the latter should work freely and be of sufficient length to function properly; the rear end of this firing pin should not be burred over, and the spring should not be rusted or stuck.

Snap the hammer a few times and notice its action; percussion should be good and the trigger should snap back smoothly and quickly to its forward position. Test the double-action pull; this should work smoothly and the hammer should "break" cleanly from the notch when it falls. When at full cock, the hammer should notch at the rear of its travel; there should be but slight additional rearward play.

The side plate should not be "sprung" away from the frame at any point, but should fit flush all around. The screws which fasten it should not have burred heads or torn slots; if there are indications of such it may mean possible repairs in the past, or at least the dismounting of the arm by an unqualified person.

Grips should fit to the butt with no loose play. Checkering is best with clean and sharp diamonds which have not been worn smooth. Sights should not be bent or dented, and in the case of target guns, should have no lost motion.

In the case of an obsolete Army side arm, or a gun bought from any large stock of standardized weapons, such as discarded police models, check up on the serial numbers found on the butt, frame, cylinder and barrel, and make certain these are all the same. The gun may be an "assembled" job, made by fitting together a lot of spare parts with new barrels or such, and if so, you don't want it. The color of bluing of all main parts should be of the same shade or show an equal amount of wear. If there are no serial numbers showing, or if there are indications of these having been altered or ground off, turn the gun down.

If, in your search for truth, you find the words "SPAIN" tucked up under the trigger guard, or "Made in Spain" in small type, or the wording "for SMITH & WESSON ctg." with only the Smith & Wesson part readable, don't accept that gun as a gift—the donor has it in for you.

"The proof of the pudding is in the eating thereof"; so if it is at all possible, take the gun out and shoot it with a few rounds of service charges before you lay down your money.

Suggested Test of Automatics — First clean out the bore and examine it in a good light. The bore should be bright throughout its entire length, with no pitting marks, and the edges of the lands should be clear and sharp. If the edges are worn

or rounded over, especially near the breech, it indicates considerable wear.

The following remarks apply more particularly to the government model .45 automatic:

Test the slide for fit on receiver: There is a certain amount of play in all .45 automatics, but the play or shake of the slide on the receiver should not be excessive.

Test the safety lock: Cock the hammer, then move the safety lock upward into the "safe" position. Grasp the gun as usual, so that the grip safety is depressed, and squeeze the trigger forcibly three or four times. If the hammer falls the safety lock is worn.

Test of grip safety: Cock the hammer and, being careful not to depress the grip safety, squeeze the trigger three or four times. If the hammer falls the grip safety is worn or defective.

Test of the half-cock notch: Draw back the hammer until the sear engages in the half-cock notch and then squeeze the trigger. If the hammer falls there is a defect in the hammer or sear and one or the other will have to be replaced. Draw the hammer back nearly to full-cock and then let it slip out from under the thumb. It should fall into half-cock.

Test of sear engagement: Grasp the stock of the gun with the right hand, and, squeezing the trigger and grip safety and keeping them squeezed during the test, with the left hand draw back the slide to its full rearward position and let it snap forward. The hammer should remain cocked. In guns in which the sear or sear notch in the hammer are worn or in which the trigger pull is too light for safety, it frequently happens that on repeating this test several times the hammer will follow the slide down. If they are in good condition and the trigger pull is proper for safety, the hammer will not follow down.

Test of disconnecter: Shove the slide a quarter of an inch to the rear. Hold the slide in that position and squeeze the trigger and grip safety. Let the slide go forward, maintaining the pressure on the trigger and grip safety. If the hammer falls the disconnecter is not working properly and must be replaced. Pull the slide all the way to the rear and engage the slide stop, squeeze the trigger and at the same time release the slide. The hammer should not fall. Release the pressure on the trigger and then squeeze it. The hammer should then fall. The disconnecter prevents the release of the hammer unless the slide and barrel are in the forward position safely interlocked. It also prevents more than one shot following each squeeze of the trigger.

Disassemble the pistol and examine the following points for signs of wear:

The lugs on the bottom of the barrel. In old pistols which have been used a great deal these lugs show battering on the back. In the receiver, at the point where these lugs strike, an old gun will also show a print of the lugs compressed into the metal. Excessive wear at this point should serve as a warning against the purchase of the gun.

Examine the slide-stop notch on the slide. If it is badly worn and battered, reject the gun.

Examine the slide both inside and outside just

about where the front end of the receiver comes when the gun is assembled, and look for cracks at this point. In many old automatic pistols the slide cracks here and these cracks gradually become worse with use.

Examine the magazine carefully for shape and condition of the lips at the top. Magazines fail ordinarily by having these lips bent out of shape and also by the occurrence of cracks at the corners of the magazine at the back near the top.

CHAPTER XXI

Problems of the Trigger Pull

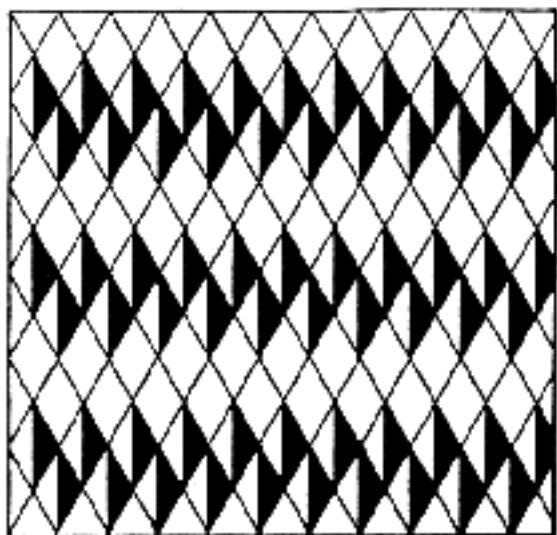

Problems of the Trigger Pull

ONE of the most mysterious parts of a firearm is the trigger mechanism, especially when the student begins any alteration to secure a better pull. So much has been written on this subject that probably every one owning a firearm has made some kind of attempt to improve the take-off and allow a more free and easy pull on the trigger. Some have been successful in their first attempt while others have ruined this part entirely, necessitating a replacement which is rather costly in some instances. Most firearms which come from the factory or even the government armory have trigger pulls which range between 4 and 12 pounds. The trigger pulls on fine shotguns are usually adjusted down to about 4 pounds, while on the cheaper class of the same arms the trigger pulls vary from 4 to 14 pounds. Every firearm should have a safety factor at its most fallible point—the trigger mechanism.

A large percentage of the public who purchase firearms do not take into consideration the danger connected with their use, and in order to place the so-called "breaks" in a convenient location to make them think, the hard trigger pull is the standard, and is the controlling factor on a firearm which provides time for a thought to register. Another advantage of the hard trigger pull is the fact that the arm cannot easily be discharged by accident. Accidents happen to the experienced as well as to the inexperienced person, and a firearm will discharge itself by a sudden jar if the pull is too light.

The hammer or cocking piece should be well supported by the full width of the sear, and the leverage of the trigger increased to a degree where the finger requires some force to pull the sear from the notch. To solve the problem of creep or take-up, reduce the finger pressure within the reasonable limits of between 3 and 4 pounds, and at the same time remove any perceptible creep.

Triggers are divided into five classes from the standpoint of mechanical arrangements and their action under finger control from the trigger. These are: the plain trigger, bolt-action trigger, set triggers, the shotgun single trigger, and the trigger mechanisms on automatic pistols.

Plain Trigger — To classify plain triggers in the proper manner would necessitate going into the history of firearms and following the development in the arrangements of the sears to the tumblers, and then the trigger in direct contact with a notch in the hammer. The last is before us today in the independent or loose form in shotguns, and the sears are engaging factors which should be altered by stoning at the engaging points, the tumbler notch and end of sear.

Before advancing to the actual work of reducing trigger pulls, the student should be familiar with the mechanical features not only of the plain trigger, but of the other triggers which come under the same heading. Study the different types of levers, as these may be of interest when you want to know what points to start and stop at, in order to reduce or increase a trigger pull to suit a particular condition. We may also refer to mechanical diagrams to prove the composition and resolution of forces, but as we are not constructing a new firearm these will not be essential, so we will get down to facts in the actual work and show the direct working cause.

In all plain-trigger mechanisms, there are either two or three essential working parts to consider: the hammer (or tumbler), and trigger or tumbler, the sear and trigger. These arrangements are in shotguns, single-shot rifles, revolvers, pump-action arms, etc. On some single-shot rifles and automatics as well as rifles and shotguns there is an intermediate sear. These hammers also have the half-cock and full-cock notches. In such cases the sear is really a part of the trigger itself, except that it is arranged in such a manner as to give greater leverage and thus increase the safety factor between the two.

To decrease a trigger pull and eliminate the drag or creep requires much patience, but the only appliances required are an oilstone and the necessary tools to disassemble the arm. The oilstones required are $\frac{1}{4}$ -inch, three-cornered, fine knife-edge, and Arkansas stones in the same forms. The oilstones come in various sizes and are listed in the diameter of which they take form. A $\frac{1}{4}$ -inch stone simply means one that measures one-fourth

inch across. Length is usually set at a standard; therefore any one wishing a selection of stones should consult Chapter I, or a specially prepared display board shown in any up-to-date hardware store. In addition, there should be included a jeweler's eyeglass of low or medium power to inspect the surface that is being worked on, in order to detect any unevenness or rocking motion of the stones.

When working on a trigger pull, the first operation is to polish all parts. If you do not have polishing heads or motors, finish the flat surfaces (do not touch the contact points) with fine emery and crocus cloth; then stone the contact points to reduce the pull. In all stoning operations, a trigger tester is a handy part of the equipment; this is a small round spring scale which records weights by quarter pounds up to twenty-five pounds.

To obtain the required pull on a plain hammer gun, note carefully the shape of the sear and the flat surface where it engages into the notch. Some have a sharp point. Then study the notch in the hammer in its relation to the end of the sear. Most rifles come from the factory with the sear engaging heavily and this is the cause of nearly all heavy trigger pulls. They are made so for safety. When the trigger is given any tension it must travel out of the notch. "Cam" the hammer back some distance before it is clear; this is operating against the force of the main spring in its full compression. By stoning the notch and end of trigger parallel to each other, and at right angles to both the hammer and trigger center, the reduction in the pull is very appreciable. Therefore, in squeezing the trigger you have eliminated the cam effect upon the hammer.

The beginner often makes the mistake of stoning the hammer notch in a manner that allows the trigger to disengage at the slightest pressure, for the spring tension allows the hammer to ride free over the trigger. Naturally this is a dangerous condition, for a slight jar would cause the accidental discharge of such an arm. A very simple test for this is made by placing the thumb on the hammer and applying pressure; the result is that the hammer falls as tho the trigger were pulled.

To secure the most satisfactory pull, start with a three-cornered fine oilstone stone the notch of the hammer at a right angle or near to a right angle, then stone a slight radius on the trigger. Too much care cannot be used in performing this operation to avoid placing a rounded contact point in the center of the trigger as well as of the hammer. An inspection should be made to see that too

great an amount of travel is not left upon the hammer notch, for this produces creep. When this has been accomplished and your judgment pronounces it as perfect as possible, polish the contact surfaces with an Arkansas stone to the degree of luster. Assemble them and test for the pull. It may not be correct, but you will discover a marked improvement with the efforts made on the first attempt. I would not advise any lighter pull than four pounds, except on a target revolver or rifle in this class. The reason I have cautioned you to use so much care in stoning trigger and hammer notches is because of the timing of the trigger and hammer. These have been made a certain length, and if too much metal is removed from the end of the trigger, it may throw some other part out of time. Generally very little stoning will accomplish the desired results.

In stoning the notch on the hammer, the three-cornered stone should always have a sharp edge, for if it is not kept sharp, it will round the inside of the notch. A certain amount is permissible, but too much is decidedly a detriment. The use of a file is not advisable in reducing trigger pulls, for in the hands of the inexperienced it removes too much metal. In a number of cheap arms the parts are soft and the use of a file, at times, is an advantage; however, a good oilstone may always be relied upon to produce the best results. Many hammers and triggers, particularly in the cheaper arms, have but a tough outer hardened surface, and when the slightest amount of stoning is applied to these, the parts become very soft at the contact points. Such parts should be case-hardened after they are reduced and then polished with the Arkansas stone before assembling.

To test a hammer and trigger for true parallel surfaces against each other, square the trigger contact surface. This may be done in two ways: first, with a small knife-edge square held against the side of the trigger with the blade over the contact point, secured by clamping the trigger against a square block of steel. Only allow the contact point to project slightly at the desired angle, and with a fine oilstone lying flat on the top of the block, continue to stone and raise the trigger until a true parallel surface is produced. With the oilstone, carry out a true radius by stoning lengthwise, meeting at a square top. A trigger stoned in such a manner is certain to be perfectly square, and this is the only reliable method to use when working to precision limits.

Having established a perfectly square contact surface on the trigger, the hammer must be done similarly, but in a different manner. Before assembling the parts, coat the surface of the notch

with the coppering solution given in Chapter XVI, Volume II. This may be applied with a toothpick. When all parts are assembled, apply pressure to the hammer by pressing it forward with the thumb, and at the same time disengage the trigger from the notch with the index finger. This treatment will show the high point which must be worked down with the fine oilstone until the contact surfaces are perfect when in contact with each other. A number of trials will sometimes be necessary to secure this perfect condition. When stoning a hammer in this manner, clamp it securely in the vise between lead jaws, for if such parts are held in the fingers, very unsatisfactory work is the result.

If a notch is made unusually deep—and this is often encountered on some hammers—rather than reduce the hammer or hammer radius, a small pin can be set in. A No. 54 drill is used first; the hole is enlarged with a No. 52 drill, and a piece of $\frac{1}{16}$ -inch drill rod is driven into the hole. File off the pin a little at a time until the trigger is permitted to engage the hammer notch at the correct depth, giving a clean pull without the least indication of any creep, and at the same time being deep enough so that the hammer cannot be jarred off in any way. Another method which can be used to overcome the same condition when a drill press is not available is to tin this part and place a drop of solder in the notch. File it off until you can secure the same crisp pull as described by placing in a piece of drill rod.

Revolvers—I shall only refer to target arms under this heading and disregard the cheaper arms altogether. The rules of the United States Revolver Association allow a minimum trigger pull of $2\frac{1}{2}$ pounds for revolvers in the "Army Revolver" Match. For single-shot pistols the minimum pull is 2 pounds. For military revolvers and pistols or pocket revolvers, such as service arms in the police departments, the minimum pull allowed is 4 pounds. There is also a special match based upon the international rules, with no limit on the trigger pull. Since all trigger pulls are tested before the matches by means of a trigger tester registering the pull, each individual should be very particular in correcting his arm to meet the prescribed rules.

When a user of a target revolver attempts to doctor up his pull, it usually results in returning the weapon to the factory; or if it happens in my bailiwick, the sad report of a new trigger and hammer reaches me. For the beginner this is a job requiring considerable forethought, and too much care or patience can not be exercised. The

character of the pull is really most important. We express this in words to the effect of "its smoothness," which is better than the pounds in weight. When stoning a trigger and the hammer notch, strive for smoothness first; eliminate the creep and grating condition with your first attempt, before any actual work is started on a trigger or hammer.

By removing the side plates on either a Colt or Smith & Wesson revolver, the student can study the mechanism of these arms. On a Smith & Wesson revolver, by removing part of the tension on the strain screw, it may be placed in the cocked position. Release the trigger gradually and note the disengaging feature of the trigger out of the hammer notch. The character of the pull depends upon the rubbing surfaces, and the distance the trigger must travel to disengage from the notch. There should be practically no tension on the spring during this examination. Now, gradually tighten up on the strain screw, and note the difference.

When making this examination and study, it will be well to use a reading glass of rather high power, fastened upon a stand in such a position that the working parts will be greatly magnified and enable you to judge what is to be done much better than you could with the naked eye. One particular point which will arrest your attention is the nose on the trigger, and this calls for a word of explanation. When there are only two engaging parts, the trigger and hammer, the former is really the sear. In such a case it is rather confusing, for in many arms the sear is a separate unit from the trigger. Therefore, to simplify the explanation, it will be best to use the term "trigger" when this is the engaging unit, and "sear" when it is a separate unit as in a shotgun.

The beginner may be assured that he will experience very little difficulty, for with study and practise he can learn to stone these parts successfully. Having the fine oilstone necessary for stoning other triggers, place a very small radius on the engaging part of the trigger (you have probably noticed that this was rather a flat surface), then polish it with the Arkansas stone. Very little can be removed from these points because the tolerance is very small; this is also the reason for using the finest of stones. The hammer notch is next. A watchmaker's magnifying glass is rather an essential addition to such operations, so that the tool marks, etc., may be seen, and also to show the results of the stoning done upon this surface. When stoning these ends and notches, the parts should be held in a small vise in a convenient position so that you can see every little movement of

your stone and at the same time have the freedom of your arms and hands so that you can detect any rocking motion of the stones.

Assuming that you have finished these parts and used the utmost patience and have only in a sense polished the engaging points, reassemble them again in the gun and test it to see what improvement has been made. Undoubtedly, you have eliminated the creep, etc., and have a clean pull; but the weight was not reduced materially, because the notch is too deep in the hammer. The next step is to strive for a lighter pull. To reduce the pull it is necessary to reduce the bearing surface on the hammer notch so that the trigger does not have so far to travel and slide out of it.

When stoning an angle in the hammer notch, care must be used in every movement of the stone; hold it so that it is possible to reduce it without removing too much. The Smith & Wesson revolvers have a very shallow notch and greater care must be given these arms than the Colt, for it is very easy to remove too great an amount at first. It may require from two to six trials before you get the desired pull and still retain the safety factor. The factories strongly advise against touching the hammer notch; nevertheless, this is the secret of a very fine pull in these arms.

At times the use of a very fine needle file is permissible, providing it is used carefully. Frequently the parts are so hard that it is impossible to use a file, and the trigger notch projects so far that an oilstone can be used to greater advantage. A word of caution will be timely here; the beginner should always use the fine oilstones until he becomes proficient in the use of files for such work. There is not one man in a thousand who can use a file to advantage in reducing trigger pulls, so as a student doing this class of work, use the oilstones and you will spoil fewer hammers and triggers.

A serious error that many amateurs commit is to weaken the main springs in order to get a much lighter trigger pull. By no means should a main spring be weakened by grinding or should the strain screw be loosened in a Smith & Wesson revolver. A bad habit of many owners of revolvers is to grind either the top of the main spring or the under side. Such principles are wrong in all respects and the results are many misfires. The owner usually blames the primers or ammunition instead of his own folly.

Automatic Pistols — To reduce the trigger pull on these arms requires considerable judgment, and to reduce a pull below $4\frac{1}{2}$ pounds is at times courting much trouble. Because of the mechanical

arrangements of triggers, sears, and hammers, on the Colt, Savage, Remington, Luger, Mauser, etc., and because of the principles of their mechanism, I have placed these in a separate class. It would be impossible to class these with the plain trigger because of the complicated method of their working forces; therefore, they must be classified separately as "automatic."

It is always better to have a trigger pull a little heavy on an automatic. If it is light, the danger point is raised, as the working of the action jars the hammer off the sear and results in misfires.

You can not study the working parts in an automatic pistol as you did on the revolvers, but you can study the principle of them by carefully disassembling the parts. The Colt caliber .45 is a good subject to work on. When stoning the sear, extra care must be used in order not to stone an angle on these surfaces, for this will allow the sear to disengage upon the sudden backward throw of the slide. Very little stoning is permissible in order to reduce the pull, but an amount which will lead to an angle is too much. Another point to remember is not to stone too much off the angle of the sear or not to place too great a radius on the end. A very slight amount is all that is required. It is rather a long-drawn-out "cut and try" proposition when reducing a pull on an automatic, so you must be prepared to spend a considerable amount of time on such arms. This is especially true of a Mauser or Luger automatic; yet the Luger is much easier in comparison with the Colt. A Mauser has so many functioning parts that working on them requires patience. Too much care cannot be used to avoid spoiling a part, for they are rather expensive.

The main problem in stoning down sears, links, and intermediate sears in the arrangements of the parts, is to eliminate creep as much as possible. Therefore, it is necessary to stone a fine surface on all the engaging points. On the lesser arms, such as the small pocket models, I do not advise trying to reduce the trigger pull, for these arms are not made for target work. When I receive a request to do such work, I usually discourage it, for it consumes too much time; besides, it is far better to leave a hard pull on these weapons because they are frequently in the hands of inexperienced shooters.

Bolt-Action Pulls — The ease of shooting with bolt-action rifles depends greatly upon the amount of force required to pull the trigger. This is characteristic of a match rifle with a heavy trigger pull. The exertion necessary is so great that it causes fatigue, and the muscular contraction tends

to throw or "flip" the rifle off its true aim. Bolt-action triggers come under a separate heading and are classed under "bolt actions." The hammer is replaced by a cocking piece, and the sear is a separate connection, but controlled by the trigger with a pin through the sear in such a location that the end of the trigger has a cam effect upon the sear to release the cocking piece. Some of the arrangements of these mechanisms are excellent, some good, and others worthless.

The design of the Springfield Model 1903 and Mauser is exceptionally fine, and in these rifles it is possible to secure excellent pulls. There is one bad feature in connection with these trigger designs, and that is the "drag" or "creep." Drag or creep is the distance it is necessary to pull the trigger back before the final pressure fires the rifle. Drag is necessary in military arms when used by untrained men in warfare or on the rifle range, but when applied to sporting arms is altogether out of place. You must have instantaneous connection with the trigger when your gun is brought up to the shoulder, for the minute the eye lines the sights and game, the discharge should take place.

A long take-up in any trigger mechanism tends to confuse the control of muscular reaction at the critical moment, and I find most big-game hunters and sportsmen wish this drag eliminated. I usually employ two methods to do this; one is to run a small adjusting screw through the trigger, bearing against the forward end of the guard cut-out; another is to place a small plate in the milled slot on the under side of the guard. Drill two holes with 1/4-inch centers and elongate them so that it is possible to make adjustments against the trigger, removing the take-up or drag altogether. By tapping the adjustable plate with a 4 x 48 tap and using a fillister-head screw, this can be made secure and positive, and it is an easy matter to make adjustments. The simplicity of the former method can be easily recognized, but the screw must be tight in the tapped hole or there is a possibility that it may work in the wrong direction, causing the trigger pull to become too light and a premature discharge is likely to occur. The latter method is positive and can soon be installed by the application of such a simple plate.

Further improvement can be made by adjusting the trigger pull. Many Springfield Model 1903 rifles that come from the Armory, as well as others in this class, require such adjustment. The Enfield is one of the most difficult to adjust, but with considerable patience a very fine pull is secured. The Krag is another rifle which is difficult to adjust as it is afflicted with a bad take-up or drag. Besides the drag, there is, as a rule, a certain

roughness to these trigger pulls which it pays to eliminate. The beginner will spend much time and effort on both the Krag and Enfield in his endeavors to lighten the pulls, but it will be a great satisfaction when completed.

It is a common belief of the amateur, if the end of the sear is ground away in both the Krag and Enfield, that the engaging distance of both the cocking piece and sear can be reduced to such a degree that a finer pull is possible; but they forget the lost motion between the bolt, cocking piece and sleeve. When ground too far the rifle cannot be cocked, as the cocking-piece notch will not engage the sear. In this case, the sear can be made to project more by grinding off some of the trigger cam. In many of these arms, the bolts can be shaken up and down by the fingers when held by the end of the cocking piece, whether cocked or with the firing pin in its downward position. Under these conditions, it is readily seen that by grinding off either the cocking piece projections or sear very far, it is possible that at times the sear may not firmly catch in the cocking piece and the rifle will be fired before the trigger is touched, owing to the looseness of the bolt mechanism. This may be tested by cocking the rifle, taking hold of the cocking piece and pulling up hard. If the cocking piece can be released from the sear in this manner, the limit of safety has been passed.

I must advise against this practise, for it is possible to secure a fine pull on such arms with the methods outlined for the Springfield and Mauser rifles. It is very easy for the beginner himself to improve the trigger pull on either of these two. Carefully examine Figure 131, which illustrates the

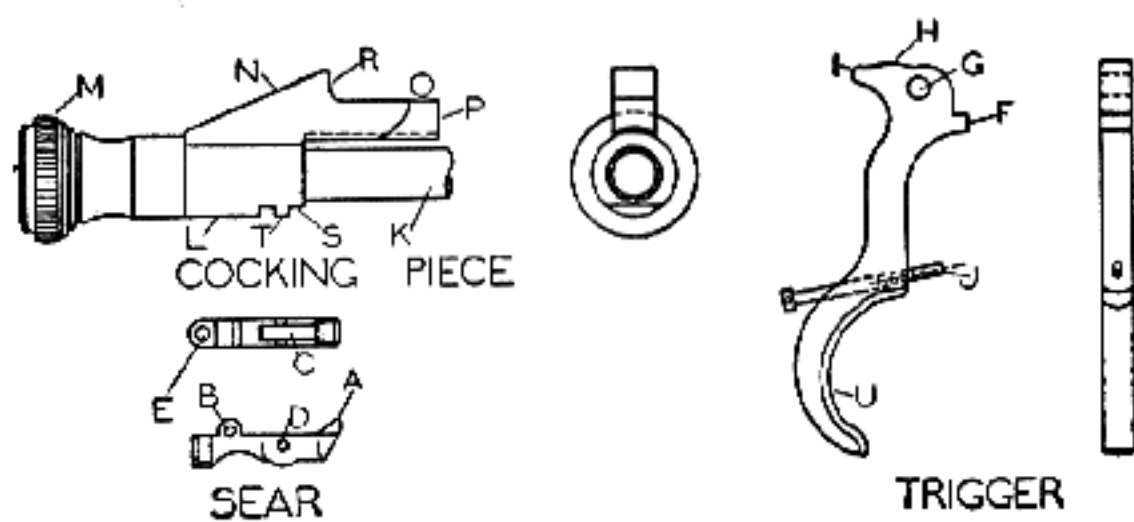

Fig. 131
Firing mechanism of Springfield Model 1903 rifle. Screw-in trigger is inserted to eliminate preliminary pull when rifle is converted to sporting arm

Springfield trigger, sear, and end of cocking piece or firing pin. We have here the trigger, both views; the trigger is hinged in its slot in the sear by the trigger pin through hole G and in D in the sear. It has a milled finger piece U to prevent slipping of the finger, the bearing H, trigger-pin hole G, heel I, and the stop F. The sear top and

side views have the sear nose *A*, pin hole *B*, trigger slot *C*, the trigger-pin hole *D*, and sear-spring seat *E*, which is occupied by the sear spring. The pin hole *B* hinges the sear in the receiver. The cocking piece and firing pin consist of the firing-pin rod *K* and the cocking piece *L*, which are made separately, the former being screwed into the latter and riveted in assembling. The length of the rod is so adjusted that when the front end of the cocking piece bears against the interior shoulder of the sleeve, the striking point will project the proper distance beyond the face of the bolt. Other parts are the knob *M*, lug *N*, cocking cam *O*, nose *P*, sear notch *R*, locking shoulder *S*, locking groove *T*. But the essential points are at *R* and at *A* when stoning for the reduction of trigger pull; *J* is the adjusting screw on the trigger to eliminate the drag or take-up, which has been explained.

By removing the rifle from the stock and assembling the guard, it is an easy matter for the student to study the working arrangement of the mechanism between sear and trigger; but between the sear nose and face of the cocking piece, this part cannot be seen; however, you may coat both surfaces of the engaging points with the coppering solution and this will give you the results of travel and effect. A careful examination shows that there are two elements to the drag; first, a horizontal pull, the distance of the travel on *H* which feels as tho one were pulling against a spring, and the second, a rather grating sensation as the trigger movement changes approximately to a downward direction. The first element is caused by the rolling of the rounded projection *H* of the trigger upon the bottom of the receiver, which ends when the trigger comes in contact with the receiver at *I*. The second part of the pull or drag is caused by pulling the sear out of the cocking-piece notch into which it at times has entered too deeply. The grating feeling, drag, or jump must be removed, and when the trigger comes in contact with the receiver at *I*, a gentle constant pressure is required until the sear snaps out of the notch, like the sudden breaking of a clay pipe-stem.

The first operation in reducing the trigger pull, after knowing the complete working forces, is carefully to stone the contact surfaces of the sear nose at *A* and the cocking-piece notch where they come in contact with each other, as Figure 131 shows, between *A* and *R*. The nose of the sear must then be given a slight radius which is true and even across the length of the flat. The side surfaces of the sear and trigger should have a high polish. When doing any of this work, the parts must be held in a vise in such a manner that it is possible to use the oil and Arkansas

stones to an unhindered advantage, but the sides of the sear and trigger can be polished on a polishing disc, by using a fine abrasive disc glued to a wooden wheel.

Now assemble the parts and try the pull with the spring tester to see just the amount of reduction obtained in the first attempt. You will no doubt find the pull somewhat reduced, and far smoother when released. You may also find a rather hard pull remaining, with still some creep or catch. This will be removed if you have the sear stoned to a high luster on the engaging face, together with a small radius on the end. Nearly all other alterations of stoning may be done on the cocking-piece notch. Your first attempt of stoning was to get it smooth and square. That being accomplished, you must now begin to stone the notch *R* to a slight angle. This is done by stoning more out of the inside and only allowing the sear to bear upon the lower side. Then, again, you will find the reverse condition prevailing; therefore, it will be necessary to stone some off the lower side. This can only be found by trials.

You may find it advisable to grind off a part of the top of the sear and also the cocking piece so that there will not be much travel, in order to secure the finest trigger pull. This has been discussed concerning the Krag and Enfield, but on the Springfield or Mauser it is possible to obtain the right pull without resorting to such methods. It often happens during your first trials of the pull and after stoning the sear and the notch, that the sear will stick and not return. This happens as soon as you take up the preliminary pull and the trigger will not return to the normal position. Two things may be wrong; either the sear spring is too weak, or the angle on the face of the sear or the cocking piece is too great, allowing them both to ride on an angle. A coat of the coppering solution on the face of the sear and the cocking piece will show this trouble. To eliminate it, a stoning operation is necessary to change the bearing surface, providing the spring is not too weak or broken.

Having obtained experience on the Springfield and Mauser trigger mechanism, you will be able to perform the reduction of trigger pulls on all other arms which have similar mechanical features. On some bolt-action rifles where the sear acts as a bolt stop it is impossible to remove the drag or preliminary pull, as the full travel of the trigger is required in order to remove the bolt. Such a long take-up or drag on hunting arms is incorrect, and they are only made in such a manner to reduce the expense of manufacture.

The Mannlicher mechanism has a roller placed in the end of the sear. I have completed a num-

ber in other arms in this manner by customers' requests. The bearing is only in the center of the roller to reduce the bearing surface and reduce friction to a minimum. It is a very good idea, but when this part is stoned and highly polished on the trigger and also on the contact point of the receiver, the roller is hardly necessary because of the short travel. It would be different if this part would move any perceptible distance; but for the length of travel it has, it is practically stationary at the point of contact.

Set Triggers — Set triggers, or hair triggers as they were first called, are of many kinds, and are found mostly on German and Austrian rifles. Charles Newton introduced set triggers on his rifles, which were very good in many respects. There have been a number of different ideas developed along this line, but it seems as tho the German set trigger will still continue to be the standard. All such triggers now in use can be used as single triggers by merely omitting to set the rear trigger. However, it is difficult to give the clean and quick release that can be obtained with a single trigger, due to the arrangement of the leverage. Of course, one may do a considerable amount of stoning and

produce a fair pull. The problem with set triggers lies in the fact that sufficient movement of the front trigger must be permitted to release the rear trigger, which then flies up and strikes the knock-off attached to the sear, thus firing the rifle. The rear trigger then comes to rest at a point considerably higher than it occupied when it was set and held by the bearing on the front trigger. To fire it as a single trigger, the front trigger must be drawn back beyond the point where it released the set trigger and until it bears either against the rear trigger in its higher position or directly upon the knock-off itself. It must come back far enough to press the lever end of the knock-off, raising it sufficiently to release the sear.

Figure 132 shows the full detailed drawing for the German type of set trigger made on the principles just described. The method of accomplishing the purpose of set triggers is to form the two triggers with the upper portions in the form of thin blades which work side by side, each being approximately one-half the thickness of the complete trigger. When used as a single trigger you can see that the straight projection of metal on the trigger is made to give the proper support due to the long

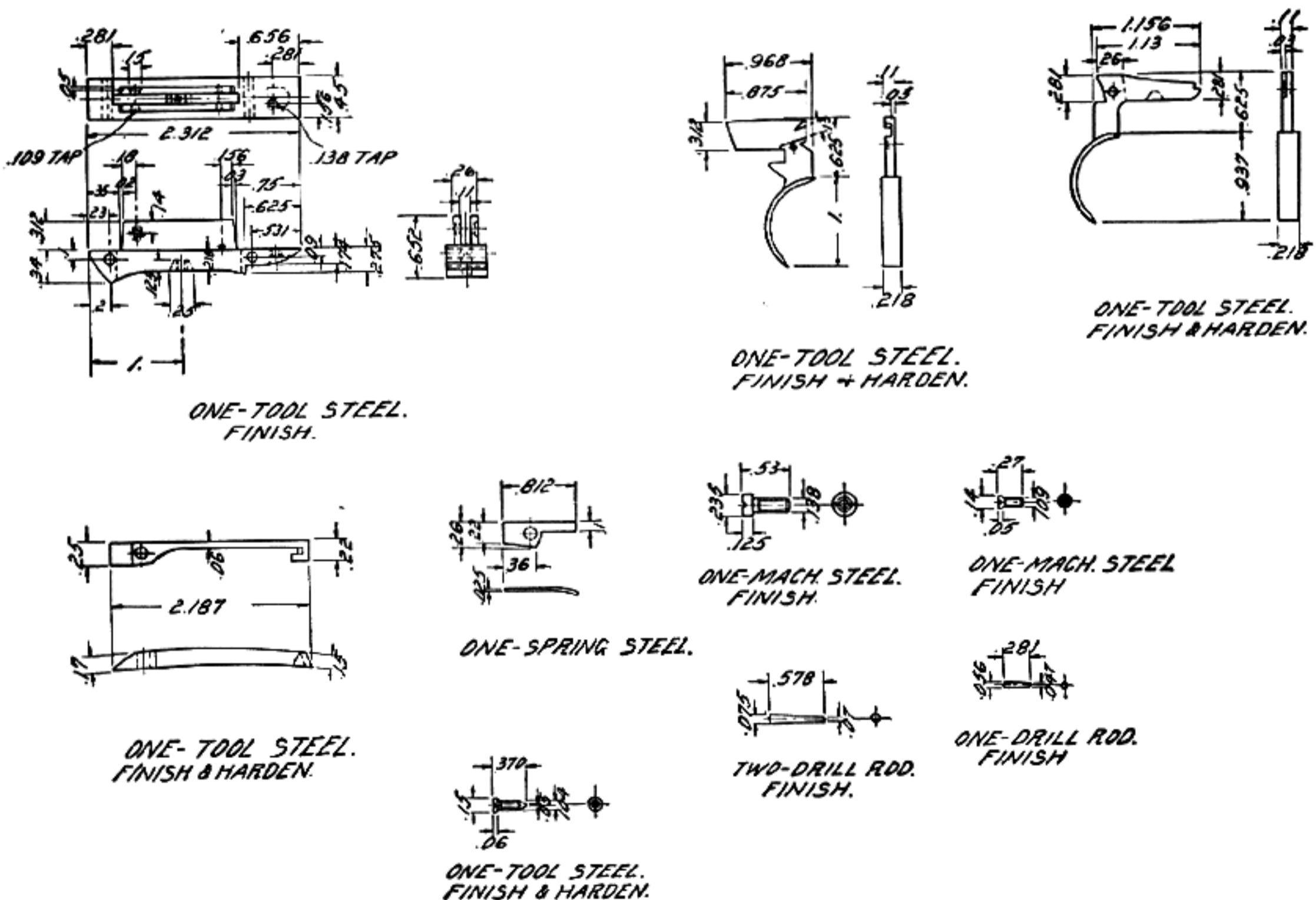

Fig. 132
Set-trigger mechanism as used in the German Mauser Sporting Rifles

leverage, and the result is a hard grating pull. Set triggers have their advantages and disadvantages, for at times they become dangerous if the end of the rear trigger wears down and releases the set unexpectedly. The adjusting screw should be fitted very tightly in the trigger plate so that when it is once adjusted it will stay in place. A loose screw is always a source of annoyance in a set trigger mechanism, and it is much better to make these to stay in position when once set.

There are two points which must have particular attention; they are the springs and the proper temper in the triggers. In the regular German type of set triggers a considerable amount of trouble is encountered in their hardness. They must be hard enough to obviate any wear and at the same time not so brittle that they will break under hard usage. Very little difficulty is encountered with the springs when they come in the standard German set triggers, but when you attempt to make these yourself, careful attention must be paid the temper.

The mechanism of most set triggers differs considerably. In one case the forward trigger is set; when it is necessary to use it, you push the front trigger forward and use the rear as the regular trigger, both triggers facing one another. Then there is the single set trigger in which the one trigger is pushed forward to set it. This is found on some of the Winchester arms. The mechanical features of all these triggers are very similar in construction, and the general directions and descriptions for making, as given in the first part, cover about all that can be learned except by a careful examination. However, it will be noticed that it has a sear at the front trigger. The notch or shoulder is the front trigger; one slides into the other and is engaged as the spring pressure is applied. The disengaging feature is the weight set against the front trigger, which allows the rear trigger to snap back, hitting the knock-off. At times the rear trigger becomes too short, and by annealing this and lightly tapping the full length of the flat portion of trigger, it is possible to stretch the metal to a length which will place it back in the correct position. Harden and temper the trigger as previously directed. It may also be necessary to lighten these, as the adjusting screw will not take care of this part. The usual stoning and polishing of the engaging points is necessary. Generally, the adjusting takes care of the points I have mentioned, and it is the rear trigger which needs only a slight stoning operation.

Shotgun Triggers — These also come under a separate class, because of the mechanical features

of the arrangements of the triggers, sears, and tumblers. By changing these into different positions we get greater or lesser pull; but there is no need for going into an explanation, as they are fixed points and we cannot change them; what we are interested in is the trigger pull. Nearly all shotguns are constructed on the same principles, with the long sear, regardless of whether they have box, side-lock action, single, or double triggers.

I will not give long descriptions of the principles of a shotgun-trigger mechanism, but rather discuss the difficulties encountered with these triggers. The first consideration, when picking up a shotgun, is to test for the freedom of the triggers against the sears, to see that there is not too much pressure there. A trigger should have the freedom of at least the thickness of a piece of paper at the engaging point and work down to a pull between $3\frac{1}{2}$ and 4 pounds.

Assuming that snap caps or dummies are in the chambers, it is now possible to test for the trigger pull without any danger of breaking the striker during alterations for the required pull. It has frequently happened that one or the other side of double shotguns or double rifles pulls harder than the other; one side may have a pull of 3 pounds and the other as much as 8 pounds or more. If the triggers are free against the sears, they must be stoned on the engaging point to increase or decrease the pull so that there will be the same weight on both sides. If it should be a box-action lock, it is necessary to disassemble the gun. This means that the stock be completely removed, including all the screws which hold it in place, and also the pins that hold the sears. If it is possible, remove the stock without releasing the hammer. Study their position, and if it is necessary to remove the sears, do so, for they can be put back in place, and the gun cocked by assembling the barrels into the action and setting the forearm in place. Having cocked the gun and released the sears two or three times, you will easily get a direct understanding of how these are released from the tumbler notches. While observing the disengaging of the sears from the tumblers, notice the angles on the end of each, particularly the bearing surface. You will also notice the difference between the one which has the light pull and the opposite with the heavy pull. The one which has the light pull has more radius, and the one which has a heavy pull has a greater angle requiring more force to remove it from the notch.

You will rarely find it necessary to remove the tumblers to stone notches, and if you do, use only a fine Arkansas stone. As these were cut in very shallow, much damage can be done with even a

fine oilstone. After the sears are removed, examine these notches with a magnifying glass, to see if any work is required with the Arkansas stone. If they appear rough and show tool marks, it is necessary to remove them by polishing the surface. If not, leave them in place, as it is usually difficult to reassemble them.

The sears must be stoned on the ends in such a manner that the weight of the pull becomes even on both sides. The angle is usually stoned back so that it is free of the top of the notch in the tumbler; then a slight radius is stoned on the end. This is made so that it has an even bearing in the notch, and the size will more or less govern the pull. Some sears do not require any radius, but instead, an angle, because of the shallow cut-out in the tumbler. Therefore, you must govern your methods of stoning the sears so as to have both triggers release with the same weight.

You will find that it requires a number of assembling and disassembling operations to secure the correct pull. Instead of placing the action back into the stock for every test you make, only assemble the trigger guard. First, cut a piece of small gas pipe of the correct length and place it between the upper tang and trigger guard. The rear screw is tightened against this, securing the same results as tho it were in place in the stock. With this space between there will be no spring to the guard when the triggers are pulled. Place the barrels in the action with the forearm in place and test for the pull. The work you have done makes a vast difference.

Some other changes are made to bring the pull down to the required weight, a pull which will be clean and one that requires a pressure on both triggers of about 4 pounds to release the tumblers. The pull should be without the least suggestion of drag or creep. Practically every cheap shotgun as it comes from the factory needs some adjustments in order to suit your requirements in trigger pull. While all this work is being done it will be well to give the arm a complete polishing of all parts as described in other chapters. The working parts should open and close with freedom and the working of the locks should have a ringing sound similar to a delicate piece of machinery when opened, released, and snapped.

Shotgun Single Triggers — There are so many different single triggers on double shotguns that it is difficult to select a certain one and say it is better than the others. There will come a time when all shotguns and double rifles will be equipped with single triggers, from the standpoint of practicability and various other reasons, such

as the design of stocks and length. Shifting from one trigger to the other, changes positions of length; therefore, a stock made to measurement for the forward trigger is too short for the rear trigger; but on a single trigger the length, when once established, is set.

I admire the Lang single trigger because of its simple construction, so I base most of my judgment upon single triggers from the simple mechanical features which are included in the Lang patent. They are not selective as a number of other patents are, but I believe that very few men use this feature, or take advantage of it, even tho it is on their guns. It would seem that a selective single trigger is only a matter of choice, and when considering extra levers to install this feature, they must be put in a position which is accessible, and arranged in such a manner that the slightest touch will shift the position. This should be incorporated in the safety thumb-catch on the tang and arranged in such a manner that one will be independent of the other. When that improvement is made, more people will be in favor of selective single triggers.

The advantages of a single trigger over the ordinary two-trigger mechanism are many; a few of these are: There is more time for firing both barrels; the grip need not be relaxed, which is required on two triggers; gloves may be worn without causing any inconvenience; trigger pulls can be regulated as easily as on double triggers; ordinary intercepting or safety levers are possible.

When a single trigger is built it should have extreme simplicity of its mechanical features and still be heavy enough so there will never be any danger of these coming out of adjustment; at the same time it should act independently of recoil. It would be difficult to pick out any particular single trigger and list the various parts, because there are so many. I have already commented on the simplicity of the Lang trigger. Other makes may be similar, as for instance, the Westley Richards, therefore I shall remain neutral in the matter and allow the gun user to make his own selection. A single trigger is so arranged by mechanical movement that it is possible to change from one position to the other by levers, cams, and springs. The mechanical arrangement allows first one barrel to be fired, and the release of the finger upon the trigger allows the other tumbler or lever to catch. The same amount of pressure releases the other sear and discharges the weapon. On single-trigger arms, the same length sears are used as on double triggers, except for the length of the end projection to engage the lever. Furthermore, the weight of pull can be made to any pressure required without fear of faulty operation or the simultaneous dis-

charge of both barrels. My advice to the beginner is to study these and understand the working principles thoroughly before trying to disassemble them, particularly the more complicated kind. With the simple ones, built on the same principle as the Lang, you can remove all items with freedom, because there are so few working parts.

Speeding Up Lock Time — This question is always in the minds of target shooters, and extensive experimentation has been done these past ten years on this one problem. It is only natural that when the student completes the adjustment on the trigger pull, he desires to speed up the lock time to suit his fancy. The Winchester Model 52 has a very fast short striker, but the Springfield Model 1903 and M I .22 caliber have been more or less neglected, except those on which the lock time has been improved. I have never thought it particularly advisable to speed up lock time, and have only done it when a customer so desired. Nearly all of this work has been applied to single-barrel trap guns, and even that requires the making of all new parts; the same applies to bolt-action rifles.

This operation is done in a number of ways, depending upon the type of action. The principles employed are: shorter hammer or striker fall, heavier and stiffer main springs, lighter hammers or firing pins, removal of weight from hammers by drilling; and on rifles with hammers, changing the location of sear notches in hammers or tumblers.

Flat or V-type springs, when made of the proper spring steel, have a much faster action than coil springs made of piano wire. Naturally the manufacturers tell the public that the helical or compression springs are the most durable, because they seldom or never break; the flat spring is easily broken. Helical or compression springs have replaced the flat spring because they can be manufactured more cheaply. The flat spring steel made in the United States is usually of a poor quality, but if the manufacturers would import the finest of British spring steel and apply the correct heat-treating methods, the flat V-spring would still be supreme in the construction of our American firearms. Of course, now that the designs of shotgun actions are made for coil springs, it is out of the question to substitute a flat spring; so we must be satisfied with the coil springs.

A rifle-action having flat springs and a hammer can often be speeded up by making a much heavier spring; use the old one as a model and apply the correct methods of forging and heat treatment as described in the section on "Spring Making," Chapter XXI, Volume II. The hammer is lightened by removing metal wherever possible, and

changing the sear or trigger notch so that it will not have quite so long a fall.

The usual plan of reducing the weight of a hammer is to drill holes in positions so that they will not interfere with its strength. When performing this operation, lay the holes out so that they will be spaced the same distance apart and also be the same distance from the sides. These may either be counterbored or countersunk to improve the appearance. Metal may also be removed by a milling operation, using a small end mill. Always weigh the hammer before the operations and after. Too much care cannot be exercised when doing this work. The hammers are hardened or even case-hardened again, after the work is completed. Case-hardening, as described in Chapter XVI, Volume II, is recommended for these parts.

When filing new sear notches in a hammer to shorten the travel, a thorough examination should be given the hammer and the trigger to see if this can be done. Many hammers cannot be altered because of the close work or limits between the trigger and the hammer notch, and the short distance between the new notch and the old. This must be well figured out before any work is started. Be positive that the parts will not be spoiled; also consider the possibility of securing a new one from the manufacturer. If you are working on an obsolete model you may find it necessary to make a new hammer, and this means a lot of work.

Oftentimes a new spring is quite practical when made extra-heavy and with the proper temper; still, you may be able to stiffen the old spring by the addition of a piece of copper wire, small in diameter, wound around near the bottom. At times one or two coils of small wire are sufficient, and then three or four windings are necessary to bring the spring up to a high tension in order to get a fast hammer throw and still secure the desired efficiency from the spring. Very frequently you will find that in the end a new spring will be the most practical.

When speeding up lock time on single-barrel trap guns it does not pay to try to make the old parts do, such as the springs and tumblers. These parts are usually rather complicated, and it requires time and patience to construct new ones; but the time and efforts are rewarded by better results at the traps. I have speeded up such single-trap guns as the Francotte, Lang, Westley Richards, Daley, Baker, etc., with very satisfactory results; but these arms require new parts and entail much work. If you should have the opportunity to work on the Francotte trap gun, make at least three of the sear springs and two of the main springs to get the desired results. The small sear spring is especially

important, for this sounds the ringing snap when the gun is opened and in the cocked position. When a change is made in the hammer, a new sear is required as well. Always get the engaging section well down instead of short, which makes a better trigger pull on one of these arms. Each and every gun of special construction requires special construction of the new parts in order to get the most rapid lock time.

Speeding-up lock time on bolt-action rifles is done in various ways. There was much of this done on the Springfield Model 1903 rifle after I left the arsenal, together with new set trigger. This information was published in *The American Rifleman*. The international team was supplied with it in 1926, if I am not mistaken.

I have read of advice to cut off the end of the cocking piece on the Springfield rifle to reduce the weight and then round this over on the end. My advice would be to secure a headless cocking piece from the D. C. M.*, for when you once cut the end off it allows the firing-pin rod to unscrew from the cocking piece. This rod is threaded and the cocking piece is tapped to receive it. The pin is then riveted over and will never turn out or strip the threads from constant use. If you find it necessary to cut off the old-style cocking piece with the knob, make a gauge from a piece of sheet metal or set the combination square from the end of the rod to the cocking piece so that you can hold the correct length. Before you rivet over the end, drill a $\frac{3}{64}$ -inch hole, insert a piece of drill rod, and rivet this over on each side. Rivet over the end of the pin in the cocking piece; this makes a positive union which will never screw out of the cocking piece.

By grinding back the sear notch and also the face of the sear, a shorter travel is obtained, but too much care cannot be used in doing this, to maintain the original shape on both engaging surfaces. This alteration, together with a special spring made from square spring steel instead of the round music wire that is used, will speed up the lock time greatly. Such springs are rather difficult to make

without special tools, but when once made are very efficient, and have more tension than the round spring which comes as a standard on these rifles. Bolt-action arms can be made at least 20 per cent faster in lock time by employing these springs and giving them the proper temper.

Longer rods, together with special strikers, can be made to reduce the distance of the travel. These are made of special alloy steel which has been given the proper heat treatment. The heavier spring steel must also be employed when using these. Remember that the correct projection of the firing pin from the face of the bolt should be 0.065 maximum and 0.055 minimum. If the striker is allowed to project over 0.065 inch from the face of the bolt, it means a number of pierced primers. When lubricating the firing mechanism of any speed-up locks, use the lightest oil possible, such as given in Chapter XXV, and then use it very sparingly.

The problems of trigger pull and lock time are probably among the most vital points of good shooting and the most careful attention should be given to these essential parts of a rifle. The beginner will, no doubt, spend much time and effort in his endeavors to obtain a perfect trigger pull and better lock time. He may, in his attempts, spoil a few parts, but when, finally, perfection is achieved, mingled pride and satisfaction are the reward.

Only one who is a rifleman himself can appreciate the superior feeling gained from knowing that his rifle or shotgun has the proper trigger pull. After that, other arms which are imperfect in this respect will seem foreign and strange in his hands. Next in importance to trigger pulls are sights, and when the combinations are in perfect harmony with each other the student will find, as time goes on, that he has acquired a greater understanding of firearms and can select the perfect rifle for his own individual requirements. Carry out the instructions given in this chapter, and then turn to the question of proper sights, which, together with perfect control of the trigger, will establish your independence in good shooting.

*D. C. M., Director of Civilian Marksmanship.

CHAPTER XXII

Amateur Etching and Engraving



Amateur Etching and Engraving

A CHAPTER of this nature, to be thorough and accurate, should be written by an experienced etcher, and in my opinion the only ones qualified are those who take it up as an art in connection with Art itself. Steel engravers have mastered it, but they prefer to chisel their designs on the metal. Fine engraving is an art which involves a lifetime of study, but with a little aptness and an eye for detail the amateur can easily master etching.

I remember my early attempts at this fascinating art. We had a man in the gauge department at the Arsenal who was a jewelry engraver, and a very good one, but he used hand gravers, held these tools in the palm of the hand, and worked the metal out around the design, as we would use a scraper, only pushing the tools directly away from him. On most of the work he used a special vise with a round ball which fitted into a holder fastened to the bench and could be moved in any position. After watching him for some time, I made different kinds of gravers and tried his methods, but without much artistic expression. I found a great difference between a jewelry engraver and an engraver of firearms; the latter chips his design out with special chisels, whereas the former eats away his metal. The processes are equally difficult. The jewelry engraver makes a great many etchings, and this the student can do with very little practise.

You will note that I have listed the various etching solutions in Chapter XVI, Vol. II, and some special solutions are given here. When I made up a box with the various cleaning and repair accessories for Colonel Whelen, our engraver made the name plate to be fastened on the top lid with the Colonel's name and camp-fire motto etched in on brass. This showed up so well that from then on my interest centered upon etching, and I still find it simpler than trying to engrave objects on steel with chisels.

It was necessary for me to copy objects on tracing paper and transfer them to the plate frame of revolvers, cylinders, floor plates, guards, etc., whereas the engraver brings his designs out free-hand with needles, scrapers, dry-points, etc. Those with artistic ability will have no trouble making desired sketches on the plain parts of a firearm to make it more attractive.

Tools for Etching—The student can make most of these tools from dental burrs by grinding them to the various shapes required for etching, and then supplying them with wooden handles from ebony, yew, or snakewood. For the needle points you can use ordinary needles, setting them into wooden handles. Sealing wax is melted over the end of the holder and formed by the fingers into a smooth cone halfway up the needle. The round dental burrs, which look like small cherries, can be ground and used as burnishers. Of course, it is necessary to remove all the flutes from the burr and stone the ends to a high polish. Some burnishers are perfectly round, others have only a half-round section, and some have two flat sides and a rounded point. Two of these can be set in one handle the same as the needles. It will also be necessary to make blunt points small in size for wider lines. When you are continually placing needles in acid, the points are soon eaten away, and the needles in time can be used for blunt points. These also lose their acute angle when sharpened, and a very obtuse-angled needle means a very broad line unless the point is kept sharp. A good holder is that made by the L. S. Starret Co. as a scribe holder. It consists of a screw holder and loose steel points which are reversible when not in use. The scribe points are too long for drawing lines, but these can be ground down and made shorter, or special ones can be made. Victrola needles can be utilized and made to fit this scribe handle. These grips are excellent for dry-point.

Whether it is broad or fine, an etching needle should be blunt and perfectly round so that, when removing the varnish or wax, the hand may move in any direction without the point catching in the metal. After sharpening one of these needles on a stone, the best way to insure a smooth rounded point is to take hold of the needle on the holder and scribe circles with it on a fine hard Arkansas stone and then on some polished steel surface, making the circumferences of the circles as wide as possible, and gradually diminishing them (by raising the hand) until the needle is in a vertical position and the circles are very small. This operation wears off the irregular face of the sharpened point of steel, and any degree of bluntness without

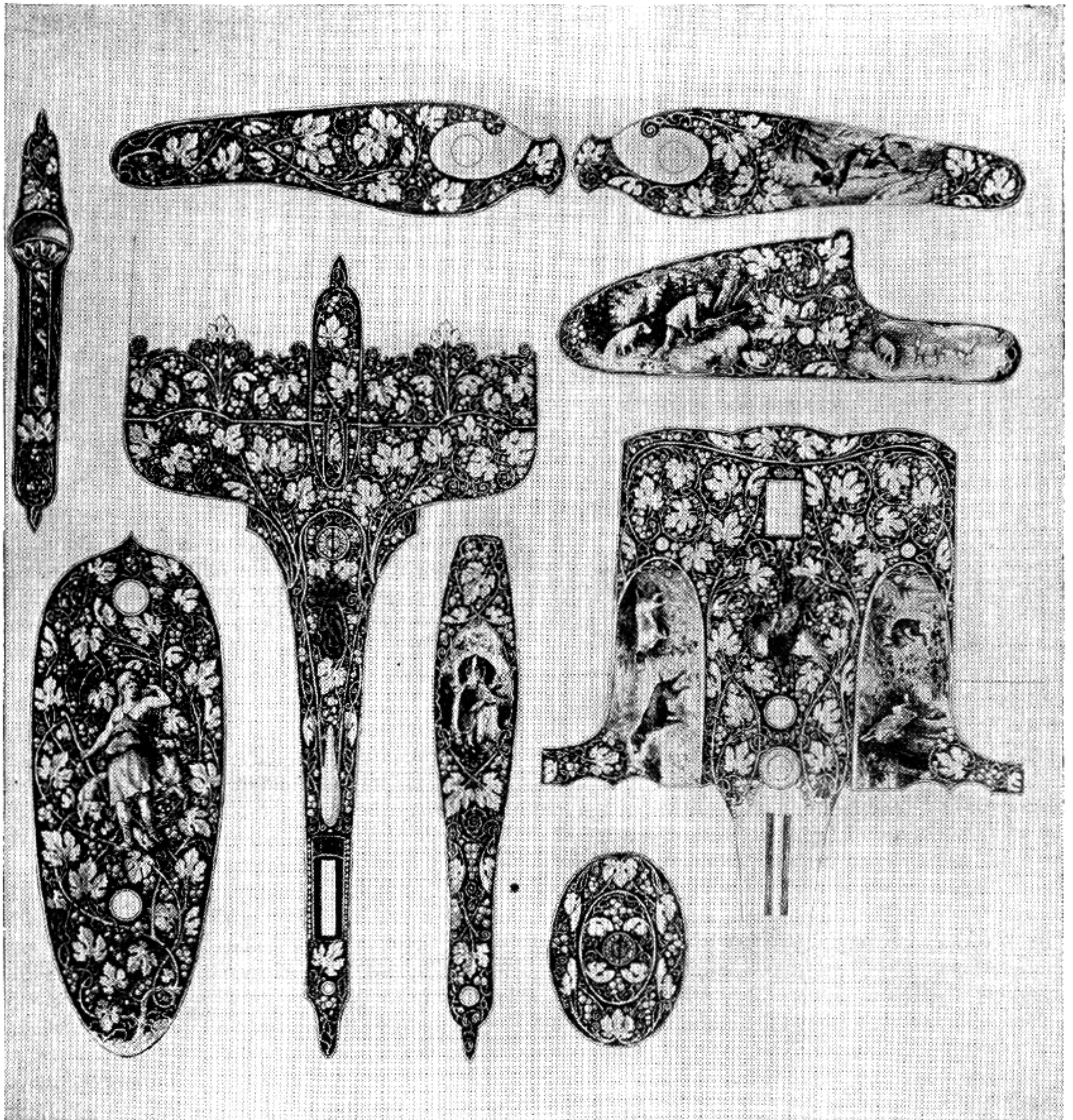

Fig. 133

Beautiful examples of the steel engraver's art. Many parts may be etched

angles may be obtained. With these, dry-point, and any degree of light or heavy lines can be made through the varnish.

Sharp-pointed needles made from dental burrs must be so constructed that the chief value lies in their extraordinary freedom in scribing lines on steel. They should not be employed on hardened steel such as revolvers, automatic pistols, floor plates, guards, barrels, etc. They will be found invaluable, as they can move into the steel through the varnish as easily as the dry-point. The needles

produce very fine cross-checked lines through the varnish which look far better than a matted surface. This process is so laborious that you will probably not want to attempt it; however, it can be done with a matting tool having very fine teeth, as illustrated in Figure 139, or with a contrivance that dress-makers use, having a handle and a round roller with a number of pointed teeth.

It would be an easy matter for the student to buy a jeweler's knurl with fine serrated teeth, and set this into a handle so that it could be rolled

over the surface. This produces a pleasing effect. The scraped-out surface around the design looks very well, but the straight fine lines between the designs improve the work greatly. If you can summon the courage or command the staying power to carry it through, matting done with the acid is beautiful. In principle it should yield a series of finely dotted lines, and at the same time form a solid black between the lines of the design. Remember, however, that this requires patience and long hours of labor.

Scraper — This can be made from a three-square needle file. Break the file off about $1\frac{1}{2}$ inches from the handle in the file section and grind to a three-sided stiletto, each face being a cutting edge down to the point. When grinding, be careful not to draw the temper by turning the point. When completely ground, the temper must be drawn to a dark straw color. Cut off part of the handle and set into an ebony handle. A good oilstone is required to keep this sharp, and each face must be

held flat on the stone while rubbing. A long cork should be used to protect the tip of the tool, with a suspicion of oil to prevent rusting when not in use. The scraper is used to pare off the surface of varnish between the designs and where corrections are to be made; also to scrape and remove sections between designs or "burrs" when needles have thrown them up.

You will also find a flat scraper necessary, made from a thin flat needle file in the same length as the three-sided scraper. This must also be ground and the temper drawn to a dark straw, set into a handle, and stoned to a sharp cutting edge on the end. This scraper is used to push the varnish away on the larger surfaces and to scrape the metal on parts where a wavy appearance is desired. The action of the hand in scraping is as follows: one side of the three-sided tool is placed flat upon the steel surface and then tilted just enough to shave off the metal when moving forward with a slight downward pull. It is gripped between the first and second fingers and thumb; the hand slides on the

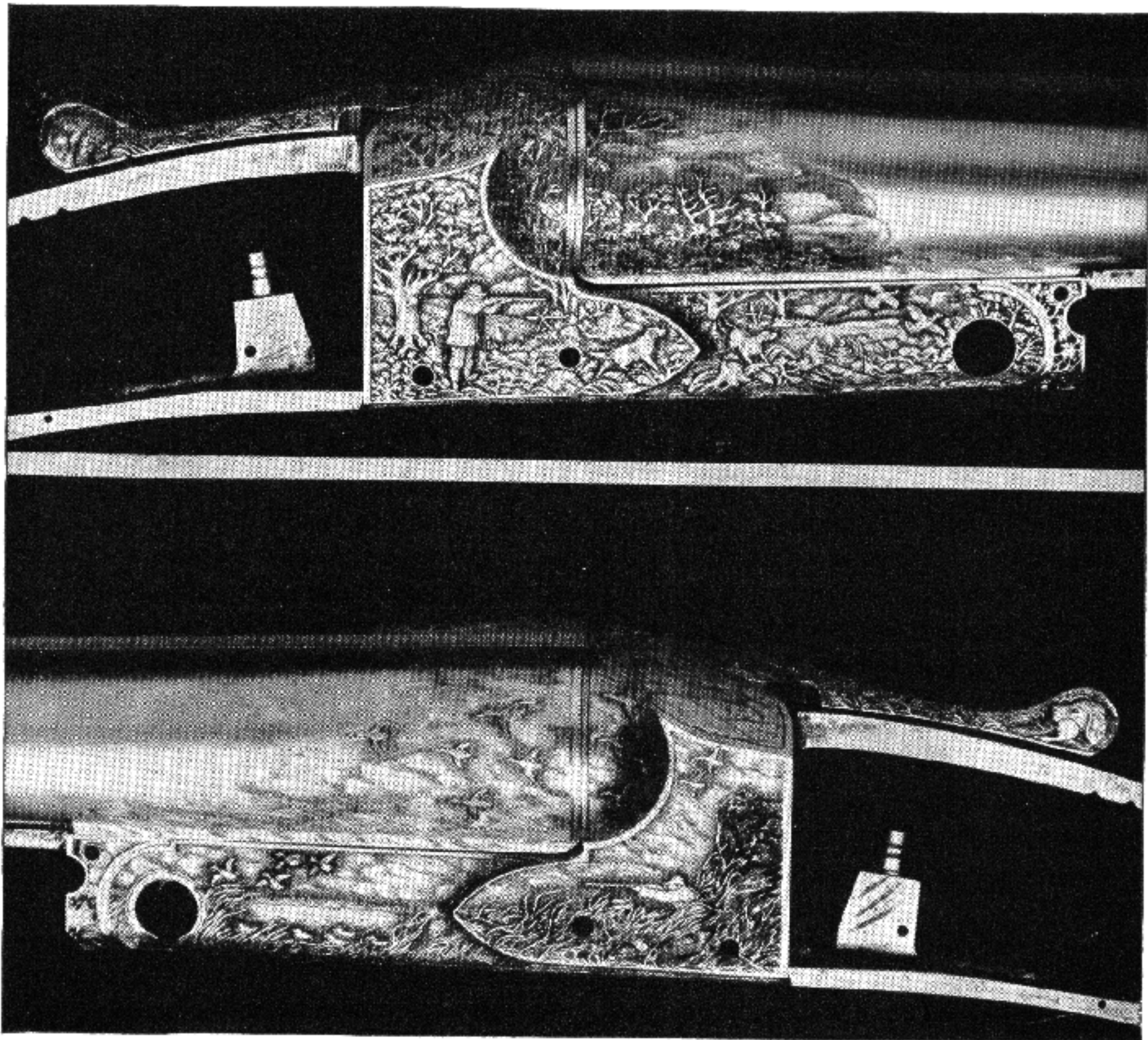

Fig. 134

Relief engraving showing cloud effect in background. This effect can also be scraped out and acid used to deepen the appearance. A very striking design for a shotgun

nail of the little finger. This enables the angle of the hand, and consequently the angle of the scraper, to be kept absolutely constant. All direction should be controlled from the elbow. The flat scraper naturally may be used in both directions. Where much scraping is to be done, the three-sided scraper can be held in the manner described, with a scraping motion toward you. Figure 134 shows what can be done with a scraper.

Burnishers — The burnisher is merely a highly polished flat or round tool used to remove roughness and scratches. The tools made from dental burrs are very satisfactory. You can make different shaped instruments from these and the half-round needle files which are set into ebony handles. The half-round burnishers may be used successfully on rounded surfaces such as barrels on rifles or shot-guns, revolver frames and guards, etc.

Graver — The burin or graver is properly the line-engraver's instrument, but a very useful though not essential tool for the student to use in etching. By its aid a line or two may be added here and there without the necessity of regrinding and rebiting. The quality of this line combines far better with that of etching than that produced by the dry-point, and is besides, more durable, as the graver does not merely displace the metal in its passage, but removes it completely. By no means will every etching job on a firearm require its use, but as a reserve tool you will find it very valuable.

All these instruments should be protected from rust; no parts should be left exposed to the action of acid. All points should be protected with cork tips, and a certain amount of sperm oil should be allowed to soak into the cork. Before using them, all traces of oil must be removed or the acid will not take effect. Figure 135 illustrates all of these tools, which were made as described; they are some of the easiest tools for the student to construct.

Acids or Mordants — Nitric acid is the most commonly used for steel, and Formula No. 28 in Chapter XVI, Vol. II, may be used successfully on soft parts of metal surfaces; on hardened parts the formulas differ. To give full details of etching, it will be necessary to go into the subject very thoroughly and give complete instructions, so I shall incorporate different formulas as I go along, using various acids to do the biting-in.

I use nitric acid with an equal quantity of water (equal volume—not weight), but you may prefer a weaker or stronger bath, such as 1 part acid to 3 parts water, or 1 part acid to 5 parts water. In preparing the acid mixture, *the water should not*

be poured into the acid, as the heat generated may conceivably crack the bottle. The water should be first measured and poured into the bottle, then the acid added. The cork or stopper should never be placed in the bottle until the mixture has had time to cool, nor should it be used until cold. It is well to hold in reserve some of the raw acid for extra-strong biting at the end of the work. The mixture may be a little too rapid in its attack until some filings have been added, or better still, a small ball of steel wool the size of a navy bean. After the first mixture, some of the exhausted acid can always be mixed with the new, sufficient to color it a pale brown.

On hardened receivers you will find it necessary to use two parts hydrochloric and one part of acetic acid. It will be wise to experiment on the under side of the receiver first to see just what the action of the acid will be. Formula No. 29 may not give the required results, therefore it will be necessary to use Formula No. 30, Chapter XVI, Vol. II. Still, I have used one part nitric to two parts water, and trials on the under side will determine results.

Another acid which is invaluable, not only mixed as in Formula No. 29 (glacial used in this formula), and the use of which you can not find in textbooks, is acetic acid. The ordinary commercial acid is best, and not "glacial," which is too strong and used undiluted. The B. P. acetic acid (commercial) is about 30 per cent in strength. Its function is to remove impurities, particularly those which have been deposited by moist hands in drawing on the steel part of the gun and may have collected in the lines, forming temporary "acid-resist" and thus causing fatal irregularity in the lines. This cleansing of the lines and flat spots from perspiration salts, etc., is particularly necessary when a gun has been worked upon for several days, as without the action of the acetic acid the most recently drawn parts are almost certain to begin biting before those passages drawn earlier. This is especially fatal where fine checkered or straight fine lines are drawn at the close of the work; in this case these last lines will jump ahead of the rest of the work of which they are a part. Even when there has been no perspiration from the hands, slight oxidation from the atmosphere is sufficient to make a difference. The action of the acetic brightens up all the lines and spaces as if they had just been drawn, and permits the mordant to reach them all immediately, and what is more important, simultaneously.

Good cider vinegar proves an efficient substitute, especially if a little common salt is added. I discovered this while trying to make the acid



Various Points

ENLARGED FOR DETAIL

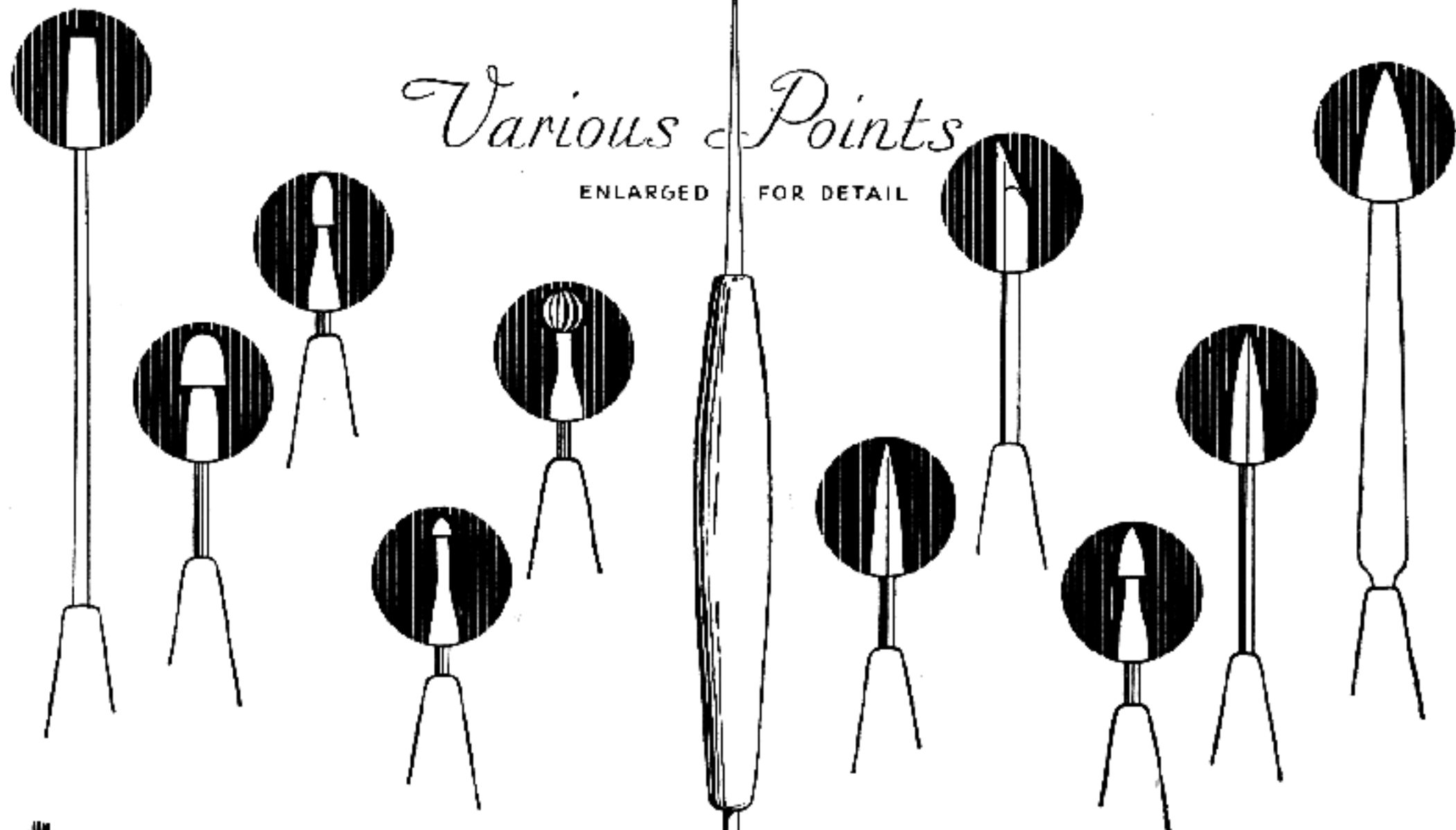

The Tool
HANDLE & POINTS



Oil Stone



Burin
AUXILIARY TOOL



Glass Rod



Sealing Wax

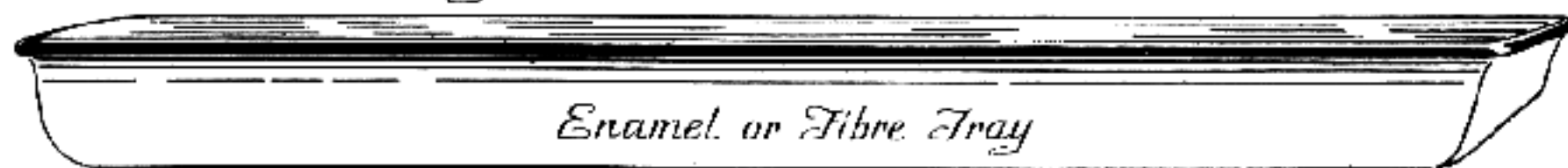

Enamel or Fibre Tray



ETCHING TOOLS and EQUIPMENT

Fig. 135

Essential tools and equipment for the amateur: suggested scroll designs

bite better by adding salt to the acid when it failed to take effect after applying it over the etching. Then I conceived the idea that if vinegar and salt were mixed together it might prove more effective. This, however, did not prove satisfac-

tory; but during the experiment I spilled some into the part where no acid had been applied. After washing this off with water, I tried the acid at that point and good results were obtained. Acetic acid, when procurable, however, gives the best results.

Bottles — The best receptacles for acids are French laboratory bottles, or bottles with glass stoppers. It is difficult to obtain the former in this country, but the latter with the large glass stoppers are perfectly satisfactory.

A glass rod should be used when only a small amount is required on a small surface, but when you immerse the work and pour the acid in lead or hard rubber dishes or trays, the wide-top bottles are best.

I have only touched upon the question of labeling bottles "Poison" in Chapter XVI, Volume

II, but further warnings cannot be insisted upon too strongly and may as well be mentioned here.

1. Label all bottles legibly.
2. Keep acids and other poisons out of the reach of children.

Whatever the shape, all acid bottles should be provided with glass stoppers. Only white glass bottles should be used to contain etching solutions. Blue or brown glass bottles are a nuisance for keeping mixed mordants, as it is necessary to see the color of the acid in order to judge its strength. The

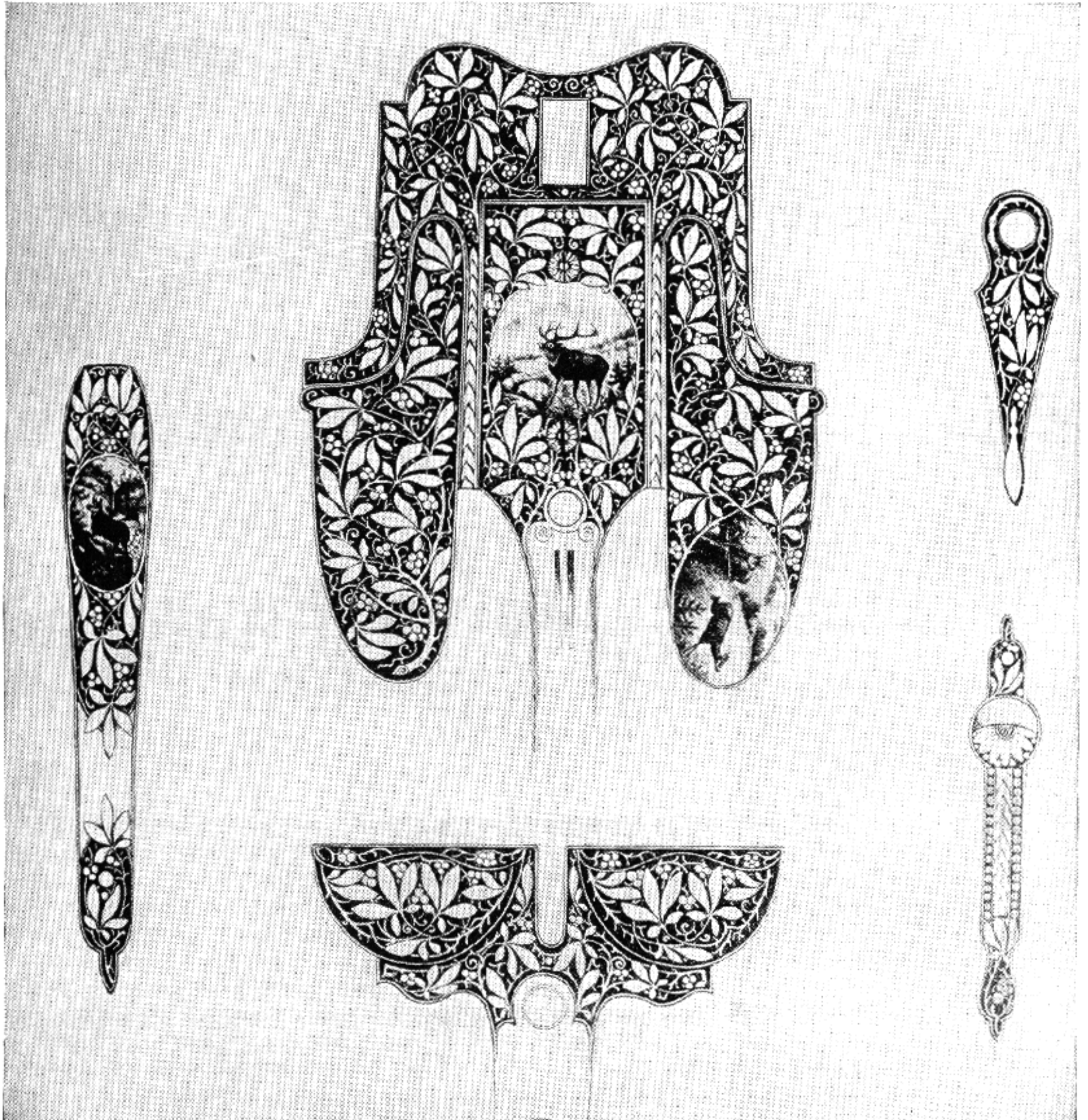

Fig. 136

Leaf effect. This design, when etched in steel artistically, gives a very pleasing appearance

more steel the acid takes up, the darker the color becomes, and if too much is used, the biting force of the acid will be nearly exhausted, resulting in underbitten lines if the biting has been gauged by time. Most of it should be thrown away, keeping a little, as before mentioned, for taking the edge off the new acid.

The more concentrated the acid, the more quickly it attacks (and exhausts itself). Pure nitric, when placed on metal, will boil furiously for a moment; a brown salt is then formed, and the action entirely ceases; the same amount of acid mixed with an equal bulk of water will continue biting steadily for a reasonably long time. Therefore, the weaker the acid, the cleaner, smoother-sided line will it bite; accordingly, the stronger the acid, the coarser, rougher-edged line will result.

Trays or Troughs — During the biting process, when a receiver, barrel or revolver is etched, receptacles large enough to hold such parts are required. For this purpose any kind of dish will serve with a glazed or varnished surface which is unaffected by acids. It is quite possible to make these in the workshop with the wood protected by a great many coats of varnish, melted beeswax being first run into the joints. It will be well to make one for barrels, one for receivers, guards, and one for revolvers and automatic pistols. The most suitable trays are those used by photographers, of porcelain or papier-maché; the latter being light but less durable.

In order to place the work in the trays, two wires should be made so that they will fit over the sides when the work is lowered into the bath. String or twine should never be used, as this is risky and messy. The twine becomes rotten in time and may snap, and if it does, everything metallic near the bath will become rusted or tarnished if it is polished steel.

Ammonia — It is well to have a bottle of liquid ammonia handy for application to any spots of acid. Next to a strong alkali-like ammonia, water is the best thing to counteract the effect of acid. If the hands begin to tickle violently, they should be dipped into water; but for clothes, an alkali is necessary to neutralize the acid instantly. Rubber gloves should be worn, as nitric acid roughens and yellows the skin; unless rubber gloves or finger-stalls are used, this must be put up with, and no genuine enthusiast ever minds such trifles. Fumes from the hydrochloric and chloric acids are nothing as compared with those from a strong nitric bath, where a large area of metal is exposed; the effects of these gases is very often noticeable even at a

distance from the bath. In order to stop the acid's action in biting, either plunge the part into water (warm water is much better than cold, as it keeps the ground from becoming brittle), or dry it with blotting paper with a little ammonia added, and rinse it under the warm water. If the part is not washed, the stopping-out varnish will refuse to stick to the ground properly. There is also a slight danger of continued action in the lines.

Stopping-out Varnishes — These are used for protecting the steel parts of firearms before placing them in the acid bath. When I first began to experiment with etching designs on steel or gun parts, I used beeswax placed in a linen or silk cloth, heating the parts up to a point where the wax would run freely over them. Then I let the steel cool completely before any design was etched in. In time I found this to be an unsatisfactory method. I then began to try different varnishes, and obtained some information from my friend, the engraver in the gauge department. He told me of a straw-hat polish or varnish which was often used, but I could not obtain it. This, I understand, is one of the best preparations to use for stopping-out. It is used also for painting over lines which have not been sufficiently bitten. A liquid in the form of a varnish should be used with a brush. I would not suggest buying any varnish on the market, for most of it takes too long to dry and is generally too thick and unmanageable. A very good color varnish which can be mixed as a stopping-out varnish is made as follows:

4 oz. shellac, white
8 oz. pure grain alcohol
45 gr. methyl—violet dye

Allow the alcohol to dissolve the shellac completely, and then add the dye. This produces a very good color to work over or to cut out designs.

The following is equally good:

1 part bitumen (asphaltum)
5 parts benzol

This varnish may be painted on the firearm with a pointed camel-hair brush. Usually the border is painted around the design; then all the remaining portions of the steel are exposed to be etched out. Naturally, the more accurate the design the better it will appear when finished. Veins of leaves are the best for the student to paint in, or different scroll designs, which are much easier to paint than leaves. Of course, by this method you can do a fair job of etching, but far better results may be obtained by the proper application of the designs, as they should be worked out with the instruments I have described.



Fig. 137
Ballard action engraved in high relief. The scroll design can be used for etching

The steel must be polished and free from any grease or oil before the stopping-out varnish is applied. All parts should be disassembled from a firearm and completely painted with the varnish. For example, on a hardened Springfield receiver, small wooden plugs must be made for the front and rear guard screw-threaded holes and the part completely painted with the varnish inside and out. The process is the same on revolvers; both ends of the barrel must be tightly plugged, and also the cylinders. A barrel must also be plugged on each end and the parts entirely covered with the varnish. When the process of etching is completed and the acid washed off, immerse the parts in boiling water or alcohol, and the varnish will be completely removed. After this is done, the design stands out clearly.

A great many firearms may be etched successfully by the student to relieve the original plain appearance. When I say a great many arms, I mean almost all the military models, such as the Springfield, Enfield, Krag, as well as factory arms. These arms are good subjects to work on, and needless to say a great improvement may be achieved by many amateurs. I begin my own work by using tracing paper and then transferring the design to the steel. It is remarkable how accurately these designs will come out. Of course this is a simple method compared with those used in the work of an artist such

as Rudolph Kornbrath; but then we pass into another class which requires years of experience and is beyond my ability. I would advise the beginner to attempt only the simple designs which I shall describe.

Screw Heads — File some simple design on screw heads rather than leave them plain, especially the screws which secure the pistol-grip cap and also the butt plate, as illustrated in Figure 138. This is only a way of relieving the plain appearance of the heads, but it shows that some forethought has been used. Naturally, the designs on all the heads should conform with each other. I advocate this on all screws which show in bold relief, such as the guard screws, forearm screws, and on revolvers where the heads show, such as the side plates, etc. File the lines very shallow on these heads, for lines that are too deep not only look bad, but accumulate dirt and oil in the cuts. The only file used is a double knife-edge needle file. Catch the screw between the lead vise jaws, and place the fine lines across the face. If you should have a lathe, fine circles may be cut and then the lines can be worked up to these. A very neat design is the checkered head. It requires a little patience to keep the lines even and straight, but you will find that with a little practise this can easily be accomplished. The fine straight lines

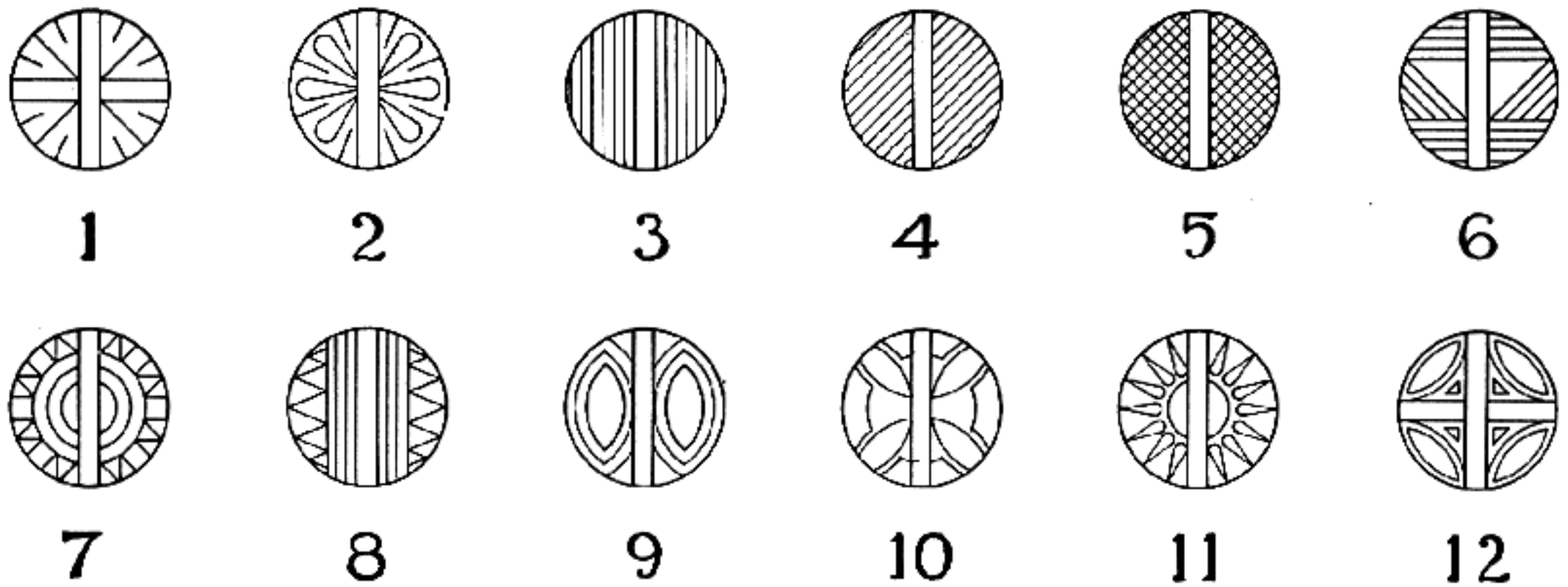

Fig. 138

Ornamental screw heads. Most designs can be made with the knife-edge file, and others with an engraving tool

also require patience. As all screws are set in north and south, lines must be designed which will not conflict with the slot; it will be seen how easily darker or deeper lines can offset the delicate finer lines used in the design. A small O in the stencil set may be brought into use; it makes a pleasing design, as does also an M, L, or W. These stencils in the 1/16-inch diameter may be used, altho they may look incongruous when reversed. In no way, by using these letters reversed or connecting, does this affect the judgment of the real amateur; it

forms a contrast to a set rule by applying something original.

The Use of Matting Tools, Etc. — Matted surfaces were used in Chapter XIII in carrying out certain border designs, following the checkering, and using a matted surface in place of checkering. Now we shall continue with the matted surface on parts of steel, mostly where the line of sights extends, as on forward and rear of receiver, rear sight base, sight leaves, ramp, etc. Making all these

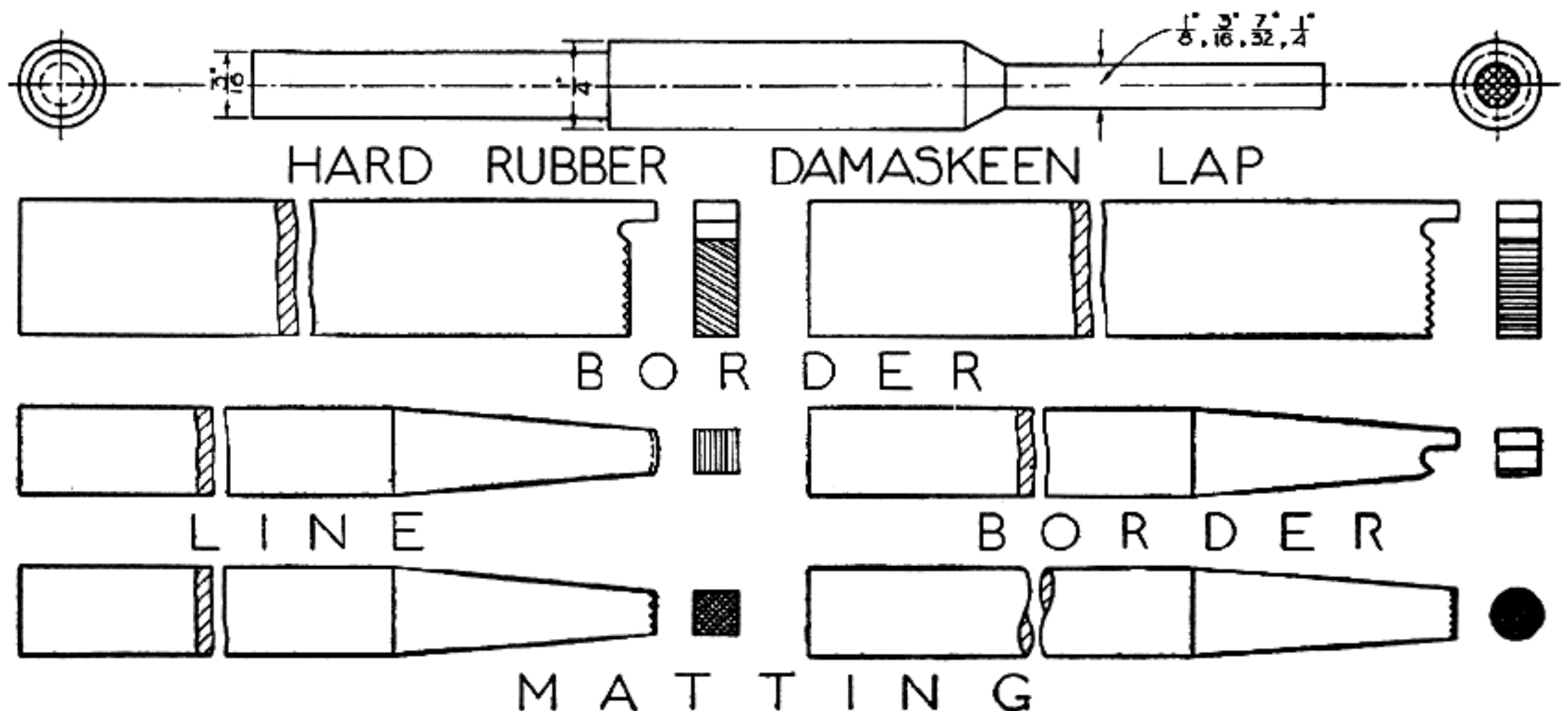

Fig. 139

Matting tools. Damaskeen lap for frosted effect. On steel or other metals

tools is only a matter of forging the ends and filing them up. Figure 139 illustrates the different tools required. Matting tools are more frequently used than any other, and it is surprising to see what a pleasing effect they produce, particularly on a ramp's incline. On a matted surface a border is essential, for carrying matting out to the edge ruins all artistic effect. This particular form of decoration may be done with a center punch, dental burr, or fine prick-punch, if you have the patience to carry a certain given proportion over such a surface. Matting is only a series of delicate points in which the surface of the steel is covered across and across in many directions until the surface of the steel becomes cut up all over and a dull appearance is produced with a minutely dotted surface. Whether this is done by a prick-punch, dental burr, or matting tool, or as a whole or piecemeal as the work progresses, the principle remains the same; good work can be done in all three ways, but a standard matting tool gives the finest results. The finer the lines in the tool, the finer the matted surface will be.

Take, for example, the front-sight ramp, which must have a matted surface to dull the surface of the incline base and obviate the glare reflected on the sight if there should be a highly polished blued surface. If you did not intend to matt this part, it would have been much better to construct some other form of sight base than the long ramp. Those without fine checkering are out of place, and the eye tells you that there is something greatly lacking even tho your brain does not register the difference. First, take the border tool; if you have already completed this, it gives a line inside the edge of $\frac{1}{16}$ inch. Rest the side against the outer edge, gently tap the tool with a light hammer, and each time you make a tap, move the tool about the width of the impression made. Continue thus on both sides until you have a sharp and well defined line from top to bottom. Now, bring the fine matting tool into use. By holding this between the thumb and index finger of the left hand and resting the nail of the little finger on the metal, or on a convenient section of the barrel, raise the tool off the metal about $\frac{1}{4}$ inch and give the matting tool light, sharp, repeated blows. The short distance the tool is held away from the work, with the spring of the little finger, causes an effect similar to that of an air or pneumatic hammer. Never hold the tool in one spot, but keep moving in a new location each time a light blow is struck until the surface is well darkened between the borders.

This, at least, is the orthodox method of doing such work. Some men, no doubt, will avoid part of

the labor by employing a center punch (which can be used) and only roughening the surface with a number of marks some of which are deep and some shallow. To begin right in those areas where matting should be necessary, you will be working from dark to light, instead of from light to dark. In other words, you can make the surface look ten times worse than the metal did when it was plain.

When matting the top of a receiver, it is necessary to have a width of matting between $\frac{1}{2}$ and $\frac{3}{4}$ inch on the forward part next to the barrel. A border must be set around this in order to make a completely matted appearance. There are three methods of doing this; one with a bent knife-edge file, the other with a graver or a sharp diamond-point engraver's chisel. It will be best for the student to bend up a knife-edge file rather than try a graver or an engraver's chisel. The bridge or rear part of the receiver is done in the same manner, except that the matted surface is very narrow.

Whenever it is possible to use the border tool on sight bases, ribs, etc., it offers a positive means of constructing a straight, even line the full length of a given distance, and the work can be done much better than by any other means. When a checkered or matted surface is worked in between, the design balances and has the appearance of a well finished job. All steel will take an impression and have the dark color, provided your tools are made fine and sharp and you move over the surface of the steel in various directions, and turn at the same time each blow is hit by the hammer; also if your blows are all given the same pressure, which should not vary over a quarter of a pound.

The wider tools are made for shotgun ribs. These have a side rest and a space which will clear the border. The width can be made to suit the rib; and the lines 30 degrees or straight across. When making the 30-degree tools it is necessary to make two; one right and one a left hand. With two tools it is possible to construct a very fine checkering job the full length of the rib or on any other form of sight base. You can also make one with the lines straight across, as illustrated in Figure 139. It will benefit you to make the complete set, for you never know when you will have occasion to use any one of them. These straight tools give a peculiar beauty to the steel, yielding a wonderful velvety richness in the design, provided they are cut very fine. When you examine such a surface under the magnifying glass you will find a burr and a groove, the burr being the ridge thrown up by the passage of the tool over the steel. Shotgun ribs must be perfectly straight across to do this kind of work, and it must be done before they are set on the barrel. If an upper rib is being considered, this

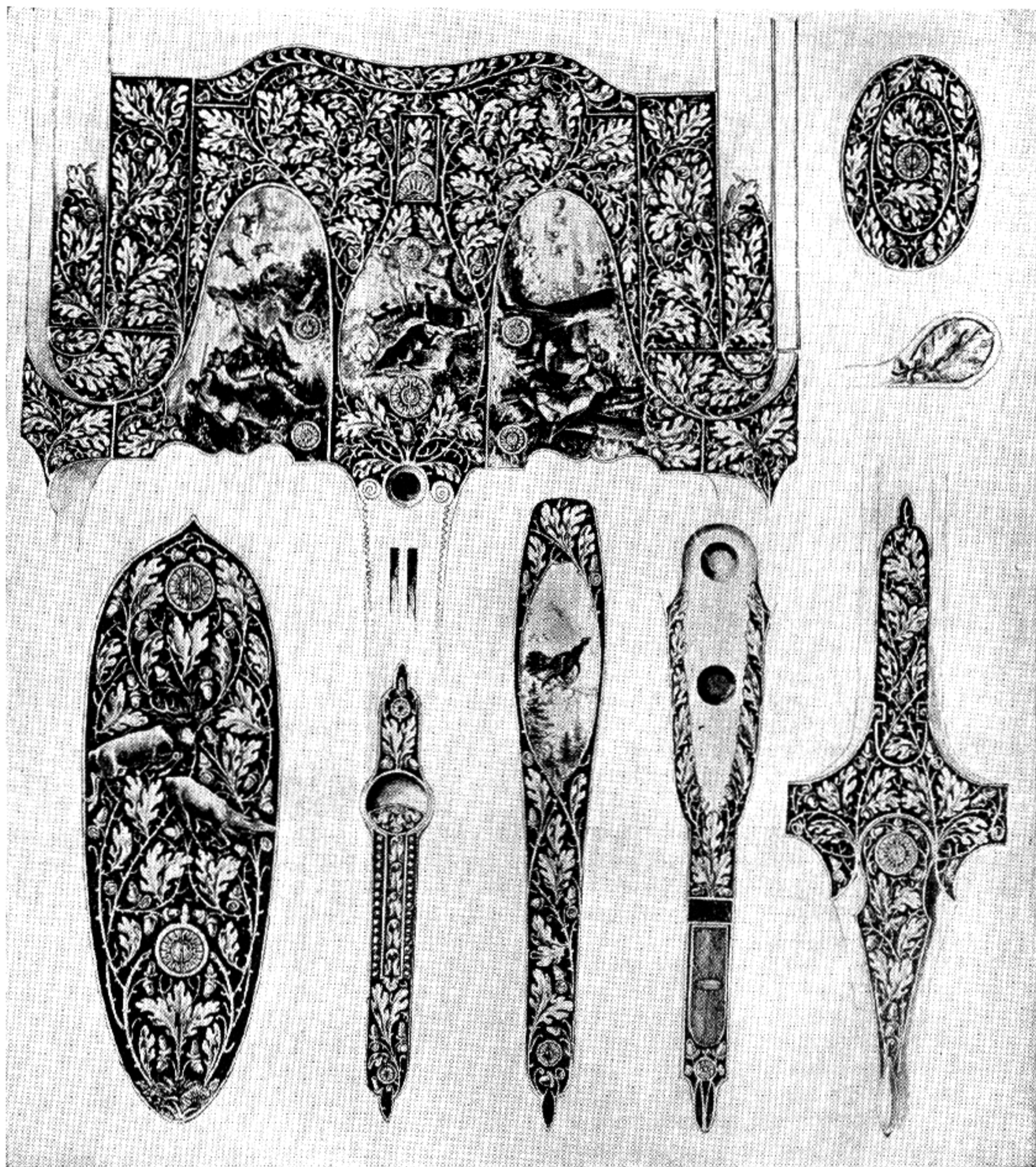

Fig. 140

Fine examples of etching or engraving to work from

may be done off the barrels. When you place such a surface on a rib it springs and curls up, owing to the stretch of the metal. It is then necessary to straighten this; this method will be described in Chapter XXV, Vol. II.

The student will find a great variety of work to be done with all these tools described, not only on parts of guns, but for decorative purposes on any metal surface. All these described applications of

the tools may be used by the art student on many subjects, particularly the matting tools. The student may find greater use for this in his particular line, especially the worker in copper, gold, silver, or steel.

Damaskeening — The high circular polished rings we often see on frames and wheels of fine watches are called "Damaskeen," which means the

inlay of metals. This finish has the appearance of such an effect when carried out in a direct or circular line, each and every ring joining one another. It is produced with a hard rubber circular lap made as Figure 139 shows. Hard fiber can also be used, but hard rubber gives superior results. A drill press is required for this operation and is run at medium speed. Flour or optical emery mixed with olive oil to a paste is used as an abrasive. If you are working on a flat surface, a light film of this is spread upon the surface, and the work is set against a stop so that it is possible to keep a straight line and also have each circle connect with the next. On the following line, the stop is moved over just so the circle fills up the space between the place where the two connect. By not wiping the film of heavy paste from the surface, it is an easy matter to set the lap between these and carry out perfectly straight and connecting circles the full length of the surface. Each time the work is moved, the handle of the drill press is raised and brought down. Very little pressure on the handle is required to produce a fine, finished circle. Too much pressure wears the face of the lap too fast, the outer edge becomes rounded, and the complete circle of the lap is not reproduced upon the flat surface. Small parts should be held in a vise and a stop set in a convenient place so that it will move with freedom. Different-sized laps should be used, varying with the size of the work; a small lap for small parts and a large one for larger work.

A polished bolt requires such a finish because it relieves the plain appearance of the polished surface and gives the metal a frosted effect. When applying this finish to such a part, cover the surface with the fine emery paste and hold the bolt in both hands, moving it in various directions against the face of the lap, lengthwise, a motion which will secure a better appearance of the finish. Around the handle and knob, different effects can be produced. When considerable care and patience is shown, a part comes out with a beautiful finish. The magazine follower or platform can be given round connecting circles so that the two parts will match.

Objections are sometimes raised to any polished surface on a firearm, based on the idea that the bright surface reflects light which can be detected by an animal at a great distance. For the man who only uses a rifle one or two weeks in the year and only in our deer country, this finish is not objectionable. But if the arm is going into Africa, it will be advisable to have the bolt blued. Many men are under the impression that this frosted appearance will show up when a part is blued, but it will not, for bluing removes this effect completely.

The inside working parts of all shotguns should

be given this appearance. It not only looks beautiful, but it is an effect which has more or less of a rust-resisting quality, due to the action of the abrasive and oil on the steel and the subsequent polish. Observe the difference upon disassembling a shotgun when some of the parts are damaskeened and some plainly polished. Those parts which did not have the finish are rather rusted in spots, whereas, the parts with the frosted effect are free from any suggestion of rust.

Engraved Receivers — There are many receivers which must be completely annealed before any engraving can be done, such as on the Krag, Springfield with numbers below 800,000, Enfield, shotgun actions, etc. The Mauser and the new Springfield actions have only a very light case-hardening on the surface, and it is easy to work under this scale without annealing. When engraving is to be done on a hardened action, it should be completely annealed, then engraved and re-pack-hardened. If you are not equipped to carry out such work, it is better to send the action to a firm well equipped to do it. Of course, elaborate and precise engraving is beyond the ability of the amateur, and if a perfect job in every detail is desired, such work should be sent to a man who makes a specialty of it, such as Mr. Kornbrath.

The question has often been asked, "Does it matter if numbers are removed from a Springfield receiver?" No, of course not, provided the action is not given a very hard case-hardened treatment by leaving the part too long in the pack-hardening material (this fault is caused by the manufacturer). When a mill file will not pick up the metal as you touch the surface, or even make an impression on any part, it is better to place such an action in an oil bath heated from 500 to 550 degrees Fahrenheit, for thirty minutes, to remove the brittleness, even tho you do not wish to remove the numbers or even engrave the action. When you remove the numbers from a Springfield receiver you take off a little more than $\frac{1}{32}$ inch of metal, provided you can file this off and not grind it; you do not realize how much metal is removed by such an operation, and on a brittle receiver this weakens it to such an extent that you may have a blown-up rifle, as I have often seen happen after such carelessness.

Whenever it is possible to remove the name and number from an action, always replace the numbers on the side with $\frac{1}{16}$ -inch or $\frac{3}{32}$ -inch stencils, which will enable any one checking up the numbers to recognize the fact that this can be referred to and checked at any time with the records at the arsenal. A Springfield receiver is

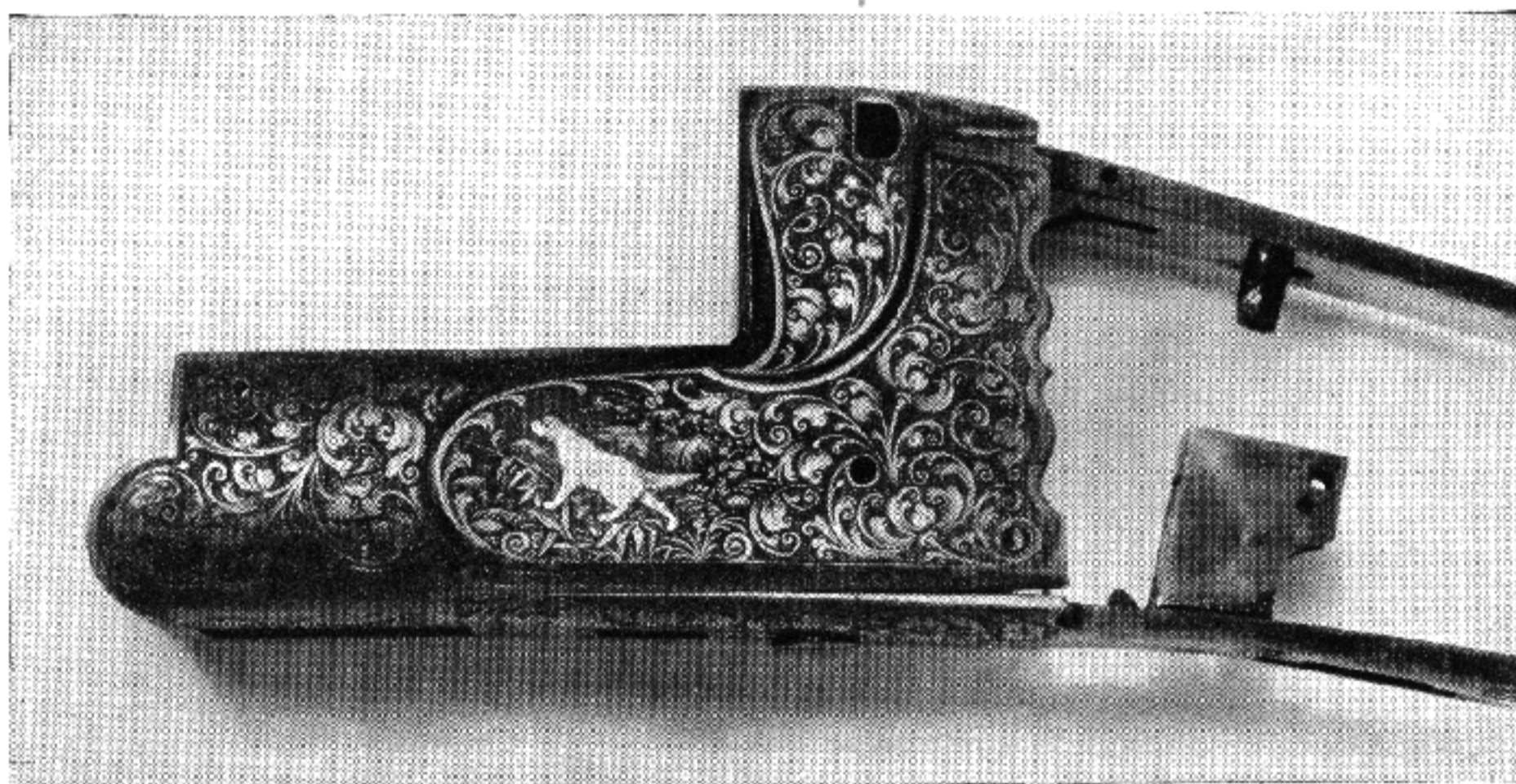

Fig. 141

Shotgun action engraved in high relief. Such scroll designs can often be used in etching

the only part of a rifle that is not expendable. All other parts are expendable, which is a government regulation.

The stamp and numbers of the U. S. Springfield armory Model 1903 are not disgraceful or unsightly; rather is it an honor to own a rifle with such a stamp, as it means that you have the best in firearms. On the other hand, when one wishes a finely engraved rifle, there is no harm in removing them and only placing U. S. SPR'FLD No.— on the side with small letters and figures, providing everything is followed out as described.

The student will find this art as fascinating as checkering and carving in wood; and here the same quality, patience, is essential; if the beginner is without it, it must be acquired. This may apply almost equally to every art. One must be prepared to spoil sample after sample before such work can be adequately applied to any firearm. After spoiling different experimental pieces, do not give up in disgust, but continue with bulldog determination, working at it in the privacy of your own shop until you have made a success of it; then call others in to view and criticise your efforts, and accept such criticism with an open mind, thus making it constructive.

One must never be afraid of making mistakes and never give up because of them. The efforts

applied to sample or even old arms will be worth while. If you think you have something definite to say when you are constructing a figure on an etching design, having probably been inspired by some good work done by others, then by all means go ahead and try your hand at bettering that work; only go at it boldly, and having made a mess of one old gun, start making a mess of another, or even a third.

Altho verbal advice from a master will save many blunders and disappointments at the outset, it is quite possible to learn what is essential from any text-book. I know this from past experience, and altho it takes longer, what you teach yourself, generally (through mistakes) sticks in a way that no second-hand knowledge can—even that gained from a teacher. Our mistakes save us from making those same mistakes again.

No one, therefore, need begin any of this work who finds it impossible to make up his mind as to what has to be done before beginning to do it. This may seem absurd, but after all, it is one of the most common failings. How many know what they really want to do? Now, in gun work, one may fumble away for months on one gun and yet arrive at something without necessarily showing the traces of one's many tentative efforts. This at least is a common enough practise.

CHAPTER XXIII

Stripping Actions, Oiling, and Minor Repairs

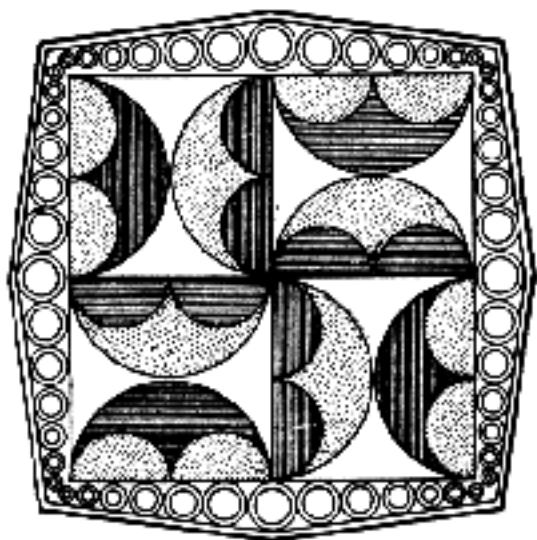

Stripping Actions, Oiling, and Minor Repairs

IN SPITE of the many arms I have handled in my years of experience as a gunmaker, I must frankly admit that I could not tell you offhand the methods I have used to disassemble, repair, clean, and oil the firearms I have worked upon, even tho only three months had elapsed since that time. There are certain fundamentals you learn in mechanics that are difficult to explain. Through constant application of these principles they become a habit, and you no longer analyze just why you do a certain thing. The person who has grown up in the environment of some particular branch of mechanics may have played around as a child in the shavings of his father's workshop, and through this association he may gradually have learned to have perfect control of every tool in that particular line of work so that his mind and hands work in harmony.

I can only give instructions which will enable a student in gun work to apply good judgment when taking apart a firearm. Of course, it will be clearly understood that you must solve a great many of your own problems when disassembling a firearm and putting it together again. The greatest trouble is not to disassemble, but to reassemble some guns, for you often forget just how they came apart, especially when you have set them aside for a week or so.

Bolt-action Rifles — While we are on the subject of assembling and disassembling a firearm, it will be well for the beginner to practise on a Springfield service rifle, as there are more of these arms in the hands of American gun lovers than any other bolt-action arm. If one should practise taking one of these arms apart and then assembling it again, one will place greater confidence in his ability to go ahead and attempt the simple dismounting of other arms which he may acquire or already possesses. To begin disassembling the Springfield we shall start to dismount the magazine mechanism. With the bullet end of a cartridge or a tool shaped like the end of a bullet, press on the floor-plate catch (through the holes in the rear of the floor plate), at the same time drawing the tool or bullet to the rear; this releases the floor plate.

Raise the rear end of the first limb of the magazine spring high enough to clear the lug on the floor plate and draw it out of its mortise; proceed in the same manner to remove the follower.

To assemble magazine spring and follower to floor plate, reverse operations of dismounting. Insert the follower and magazine spring in the magazine, place the tenon on the front end of the floor plate in its recess in the magazine; then place the lug on the rear end of the floor plate in its slot in the guard and press the rear end of the floor plate forward and inward, at the same time forcing the floor plate in its seat in the guard. The Mauser military arm is handled in a similar manner.

After taking the bolt and magazine mechanism out of the action, to dismount the rifle completely, proceed as follows:

- (a) Turn safety lock to dismounting bevel on sleeve and remove it by striking the thumb piece a light blow.
- (b) To dismount the sleeve lock, drive out sleeve-lock pin from the top and remove lock and spring, care being taken not to lose the spring.
- (c) Remove front-sight pin and remove front sight.
- (d) Press in rear end of lower-band spring and drive forward the lower band by a few sharp blows on the lug and then on top with a hardwood block.
- (e) Remove upper band screw and drive upper band forward in the same manner prescribed for the lower band.
- (f) Move upper band forward on barrel until stopped by movable stud, and then remove lower band by slipping it over upper band and movable stud. To remove upper band entirely from barrel requires the removal of the front-sight screw and movable stud.
- (g) Draw hand-guard forward until free from the fixed base and remove.
- (h) Remove guard screws and guard. It may be necessary to tap gently on the front and rear of the guard bow to loosen.
- (i) Remove barrel and receiver from stock.
- (j) To remove the lower band spring, drive its spindle out of its hole in the stock from the left.
- (k) Unscrew the butt-swivel screws and remove the butt-swivel plate from stock. The butt swivel, consisting of the plate, swivel, and pin permanently assembled, is issued complete.
- (l) Unscrew butt-plate screws and remove butt plate from stock.
- (m) Unscrew butt-plate spring screw and remove the butt-plate spring. Drive out butt-plate pin and remove butt-plate cap.
- (n) Remove cut-off by loosening the screw in the end of the thumb piece until it disengages the groove in the cut-off spindle; insert the blade of a screw-driver in the

notch in the rear end of the spindle and force it out. Remove the spring and plunger, being careful not to lose them.

(o) Remove the ejector by driving out the ejector pin from the upper side.

(p) Remove sear and trigger by driving out the sear pin from the right, care being taken not to lose the sear spring.

(q) Remove trigger from sear by driving out the trigger pin from either side.

(r) Remove bolt stop by inserting a small punch or end of striker in the hole in the left end and forcing it from its pocket.

The leaf should never be removed from the movable base except for the purpose of making repairs.

The fixed base and the fixed-base stud should never be removed from the barrel except for restocking purposes. This also applies to the barrel, which should never be unscrewed from the receiver except when one has the proper tools.

To assemble after dismounting, reverse and follow in inverse order of dismounting.

In assembling the sleeve lock to the sleeve, be careful to compress the lock and spring while driving in the pin from the bottom of the sleeve.

To assemble the safety lock and sleeve, insert the safety-lock spindle in its hole in the sleeve as far as it will go; then with the thumb piece held vertically, press against some rigid object. Introduce the point of a scriber or small punch ground for this purpose between the safety-lock spindle and safety-lock plunger, forcing the latter into the thumb piece until it slips over the edge of the sleeve. Further pressure on the safety-lock thumb piece, together with the gradual withdrawal of the scriber or tool, will complete the assembling.

In assembling pins and screws, note the way in which they come out, and place them in a dish or discarded face-cream jar.

The floor-plate spring and cut-off spring are alike except in length, the latter being longer. Care should be taken not to substitute one for the other.

The parts which are more or less liable to require repairs on the service Springfield rifle are as follows:

(a) Bolt stop: worn by continual contact with the bolt.
(b) Cocking piece: nose worn from neglect to keep it well lubricated.

(c) Lower band swivel and screw: screw, if not riveted in place, works loose and with swivel is often lost.

(d) Safety lock: thumb piece often knocked off by a blow.

(e) Stacking swivel and screw: screw, if not riveted in place, works loose and with swivel is lost.

(f) Striker: point burned by defective cartridges or broken by snapping on empty chamber.

(g) Front and rear guard-screws coming loose: keeper screws should be placed on the sides of these, particularly

when you find them working loose often. The method in which a keeper screw is placed alongside of the large screw is as follows: a tap drill is used to drill a hole just so far from the head that when this is counterbored the head of the keeper screw will engage part of the fillister head on the large screw and hold it in place.

The question is often asked: "What are the injuries which do not render the parts unserviceable on the Springfield rifle, or how can the rifle be used when certain parts break?" To such a question the following answers are given:

Bolt—The entire flange at front end may be broken off except a small portion on the opposite side from the extractor hook, which is required to hold, in connection with the extractor hook, the empty case while it is being drawn to the rear for ejection.

Cocking Piece—Moderate wearing of nose. The nose will wear until raising and lowering the bolt handle fails to cock the piece.

Extractor—Moderate wear or break on edge of hook.

The parts not essential, or only so to a degree, are the ejector, safety lock, cut-off, bolt stop, sleeve lock, floor plate, magazine spring, and follower.

In the absence of the ejector, the empty cases drawn to the rear by the extractor can be removed from the receiver by the fingers.

The safety lock is merely a precautionary device, and its absence does not affect the usefulness of the arm.

In absence of the cut-off, the arm can be loaded from the magazine, but the magazine cannot be held full in reserve; in single loading with the cut-off wanting and the magazine empty, the owner should load directly into the magazine, as otherwise the forward motion of the bolt will be stopped by coming in contact with the follower. In this case, care should be taken in drawing the bolt back not to draw it from the receiver.

The absence of the bolt stop and sleeve lock does not affect the usefulness of the arm.

The absence of the floor plate, follower, and magazine spring only prevents the use of the magazine, but does not prohibit the use of the arm as a single loader. The owner of this rifle should know such facts and appreciate the instructions given; often these can be applied to other bolt-action arms.

When the student is working on an arm, all such points as the movements of working mechanism should be smooth and free. Take for illustrations the Springfield, Mauser, Winchester, M/54, Remington 30, Enfield, etc. Due consideration must be given the bolts, as these should be worked in until there is not the least indication of any resistance. When the cocking piece is drawn back in the firing position and released, the

movement should be free, exerting its greatest striking force by the time it has reached the primer at the end of its travel. When raising the bolt and placing the cocking piece in the firing position, it should rise with ease, without the least sign of any grinding sensation on the cocking cams. Trigger pulls must be worked over; they will be treated in another chapter.

On all bolt-action rifles that have the central magazine directly under the bolt with a follower bearing against it by a flat spring made in the form of the letter M, the bolt rides hard in the upper bolt-slide channel; this is caused by a rough surface left by the broach when it was pulled through, forcing these cut-outs the full length of the action where the bolt rides. Suitable pieces of wood must match to fit this channel, allowing enough room so that fine emery cloth can be glued to the sides. Then the channel must be polished so that all deep tool marks are removed. The fine French or Turkish emery paper is used on wooden holders until a high polish is produced. You will often find extractor collars on the bolts projecting over the bolt surface. This is a common fault with bolts where the collar has been removed. This collar is bent in position when manufactured and should not be removed unless proper tools are at hand to replace it. It is an easy matter to remove the high points with a fine file with the extractor in place.

The follower must be polished to a very high finish and the rear ground off similar to the Mauser, which allows it to ride this down. Most military arms have a square end on the follower to lock the bolt open when the last cartridge is removed from the magazine, and the bolt is withdrawn with the fired case. The only part which bears against the bolt is the rib which serves to locate the cartridges in the magazine and guide the last cartridge in the chamber. Care must be given the rib so that when polishing the edge is not removed; but the top must be well rounded and polished, so it will allow the bolt to ride free over the surface.

There are a number of stoning operations to perform on the receiver and bolt, especially the bolt and sleeve. Having completed all the polishing of the receiver channel with a fine square oilstone, place a small radius on all sharp corners of the channel, particularly on the forward end of the bridge at the clip slots. Also stone the extracting cam surface on the left-hand side at the rear of the bridge. There is considerable stoning to be done on bolt cam and cocking-piece cam. The sleeve must be stoned on both sides of the channel where the cocking piece and sear notch ride. Radii must be stoned on the front and rear also. While

the safety is removed, stone the safety-lock plunger groove in the recesses so that the plunger will ride free when moved in any position. The Enfield has one of the best types of safety; it is located on the receiver next to the bolt. The Mauser and Mannlicher are free of springs or plungers so these are free in action.

Assuming that all stoning operations have been completed, the bolt is now ready to be lapped in. Assemble all parts, and mix flour carborundum with olive oil until a thin paste is formed. Coat all working surfaces even to the threads on the sleeve which screws into the bolt. With the tension of the magazine spring against the bolt, begin to work this back and forth the full length with your fingers on the cocking piece. The lengthwise movement can be worked slow or fast and will establish a perfect bearing surface on the upper sides of the channel. This backward and forward movement may continue for some time. Then proceed with the locking motion of the bolt which begins to lap the faces of the cams and threads. It will require between one and two hours or even longer to do a really good job on some bolt-action rifles. When advanced to a point where you think everything is well worked in, remove the bolt and magazine, disassemble all parts, and wash these well in gasoline. Such an operation should, throughout the movement of the bolt in operation, give it freeness. An oily movement, when once realized, can never afterward be mistaken. Then by a regular pressure upon the bolt handle it is raised with freedom, even in rapid succession. The trigger should be released with a clean, brittle snap. Everything about it will be retained in your memory. All other bolt-action arms will have the same freedom of action.

When it comes to disassembling a bolt-action rifle, the bolt is the hardest problem for most men, but very simple when once understood. The most difficult bolt of all is the Mannlicher; it is fairly simple with the exception of the rifle where the cocking piece screws on the firing-pin rod, but this is on the military model. On the standard sporting model, all that is necessary is to press the safety out of the notch and turn the rear section out with half a turn to disengage the cocking piece from the firing-pin rod. To carry out full details on all bolt mechanisms to be dismantled and assembled requires the same lengthy explanation as I am about to give for the Springfield M/1903 rifle. I select this rifle as it is one of the most popular arms. When this is mastered all others will be simple.

To Dismount a Bolt — Place the cut-off at the

center notch, cock the rifle and turn the safety lock to a vertical position; raise the bolt handle and withdraw the bolt from the receiver. Hold the bolt in the left hand, press in the sleeve lock with the thumb of the right hand to unlock the sleeve from the bolt, and then unscrew the sleeve by turning it to the left.

Hold the sleeve between the index finger and thumb of the left hand, draw the cocking piece back with the middle finger and the thumb of the right hand, turn safety lock down to the left with the index finger of the right hand in order to allow the cocking piece to move forward in the sleeve, thus partially relieving the tension of the main spring. With the cocking piece against the breast, draw back the firing-pin sleeve with the index finger and the thumb of the right hand, and hold it in position while removing the striker with the left hand. Remove the firing-pin sleeve and main spring. Pull the firing pin out of sleeve, turn the extractor to the right, forcing its tongue out of its groove in the front of the bolt, and force the extractor forward and off the bolt.

To Assemble Bolt—Grasp the rear of the bolt with the left hand and turn the extractor collar with the thumb and index finger of the right hand until its lug is on a line with the safety lug on the bolt. Take the extractor in the right hand and insert the lug on the collar in the undercuts in the extractor by pushing the extractor to the rear until its tongue comes in contact with the rim on the face of the bolt. (A slight pressure with the left thumb on top of the rear part of the extractor assists in this operation.) Turn the extractor to the right until it is over the right lug. Take the bolt in the right hand and press the hook of the extractor against any piece of stationary wood or some other rigid object until the tongue on the extractor enters its groove in the bolt.

With the safety lock turned down to the left to permit the firing pin to enter the sleeve as far as possible, assemble the sleeve and firing pin. Place the cocking piece against the breast and put on the main spring, firing pin, sleeve, and striker.

Hold the cocking piece between the thumb and index finger of the left hand, and by pressing the striker point against some substance—not hard enough to injure the point—force the cocking piece back until the safety lock can be turned to the vertical position with the right hand. Insert the firing pin in the bolt, and screw up the sleeve (by turning it to the right) until the sleeve lock enters its notch on the bolt.

See that the cut-off is at the center notch, and hold the rifle under the floor plate in palm and

fingers of the left hand. If the rear end of the follower has not been ground on an angle, extend the thumb over the left side of the receiver. Take the bolt in the right hand, with the safety lock in a vertical position and the safety lug up. Press the rear end of the follower with the left thumb and push the bolt into the receiver. Lower the bolt handle and turn the safety lock and the cut-off to the correct position.

While you are assembling a bolt, always place a few drops of gun oil on the working parts. Too much oil retards the free working of a bolt, so care must be used when applying this, particularly in a cold climate.

It would be well for the student to collect catalogs of all arms, as they generally contain useful information, particularly on the assembly and disassembly of the standard bolt actions. It would be a waste of time for me to continue with such information, as these are simple arms in construction; and as Colonel Whelen has gone into the subject of lever-action rifles in his book, *The American Rifle*, I would only be rewriting the subject from a different angle. Of course, a manual could be published for the aid of the student, for a few general ideas would not be out of place, particularly on some of the obsolete models, and even some of standard manufacture. What these are we need not state. In referring thus to American rifles or shotguns the criticism does not include our better grades, but some of the misfits selling at a price far below that at which the manufacturer can make any profit. Still, they are often what the public wants and buys. But when these don't work, the purchaser wants the gunsmith to place between six and fourteen hours' labor on such arms for a dollar and a half. Many foreign revolvers and automatic pistols come to the gunsmith's shop for certain repairs where two or three small parts cost more than the original price of the arm, and the gunsmith has another reason for unfavorable comment. It is best to disregard these arms altogether, for it is only natural that in time you rebel against such products.

Shotguns—This subject alone requires a lot of instruction, for there are many different kinds and makes, ranging from our cheap American guns to the best of British manufacture. The first consideration when working on shotguns is the necessary screw-drivers for different shotgun actions, so that the heads of screws will not be marred by using tools bought in a corner hardware store. The student will often be called upon to clean and make minor adjustments on various shotgun actions, and the question often confronts him as

to how to disassemble the gun and get to the locks and the other parts of the mechanism which make up a shotgun.

Many beginners look upon the mechanism of a shotgun as a mystery beyond their range of mechanics. No doubt a good many gunsmiths do, too. Often a good-grade double gun only needs a thorough cleaning and oiling, and this operation can be done by any gun owner with a few suggestions, providing he secures some of the necessary tools. Do not try to remove all screws in sight or try to drive out all pins, either. There are generally two screws which hold in place the guard, which must always be removed; and under that are the rear tang and trigger-plate screw. On the tang underneath the top lever is the large trigger-plate screw, which can be removed by pressing the lever to the right. Then either one or two screws hold the bottom plate; one always holds the trigger plate to the action. By removing this trigger plate it is possible to remove the stock. This rule is flexible and cannot always be followed, since actions are made differently. On some it is necessary to remove the sear pin before the stock can be removed from the action.

On an L. C. Smith double you must always remove the screw in the trigger plate where the spindle of the top lever is fastened, and when this snaps out of the trigger plate, it is generally very difficult to place it back again in the plate when reassembling the gun. This gun has a safety lever rod also which is not engaged to the action but only lies in a groove in the stock under the tang; in most cases this drops out, and it requires a considerable amount of time to discover where this slips into place, either in the action or the trigger plate.

When removing the mechanism from the shotgun the beginner should work slowly and carefully, and by all means think before removing a screw. Your screw-drivers should fit and be pressed well into the screw slot—not only one screw notch, but every screw—to prevent damage to the head in any way. If you contemplate the slightest danger of getting the parts mixed, by all means draw a sketch on paper, lay this on the bench, and place each screw or pin at the marked place on the paper. Naturally, there will be no need for such precautions after a few shotguns are disassembled and reassembled, but such a necessity may exist at the very beginning.

The beginner should form the habit of collecting small shallow jars such as cold cream comes in. The shallow ones may be used for screws, or a number may be used for an arm that is disassembled. Cards or slips of paper can be used to de-

scribe just where the parts have been taken from. When once this habit is formed, one will have little trouble losing small parts by having them roll from the bench to the floor.

The following instructions and suggestions generally refer to modern double guns much as the Anson and Deeley action. The main springs are the hardest parts to remove and assemble, so my advice for the amateur is to let these alone, providing there is nothing seriously wrong. All other work is simple enough when a fair understanding of the principles of the working parts is attained.

When a man brings a shotgun to the average gunsmith he usually wipes the old oil and dirt from the parts with a rag, looks the parts over, then puts on fresh oil—more than likely merely some light motor oil or vaseline—and then puts the gun together again, leaving indications of the grease or oil around the locks and where the stock joins the action. The owner, no doubt, has an idea that a fine oiling job has been done. This is a very poor way of doing such jobs, for a portion of the old gummy oil and dirt will be left to combine with the new, and in a short time the locks will be as bad as before. Every part of a shotgun action should be thoroughly cleaned in gasoline, allowing the action to soak for at least fifteen minutes; then, with a small round stiff brush, get into all corners while the action is still wet with the gasoline. Wipe and dry thoroughly before any gun oil is used. Chapter XXV gives the proper method of preparing the oil for actions, and it is the most reliable method for any firearm. Before any parts are assembled they should be completely polished to a high finish.

One of the best receptacles to hold gasoline is a covered iron kettle which will hold a gallon. This should be placed in a location where there will be no danger if fire breaks out.

The cheaper arms should have the parts case-hardened and then repolished. The springs on such arms are always rough, and a considerable amount of work must be done before they are placed back in the action. In fact, you will find enough work to occupy the best part of a day. In many instances you will find arms which have been long neglected, where water has gotten into the working parts and rusted them very badly. If the arms have been near salt water, the dirt and rust will combine so badly that a lot of work is necessary. In such cases the parts should be soaked in a bath of kerosene for half an hour, which will help to dissolve the rust and dirt. Care must be taken that you do not polish too much metal off the working parts (such as the locking lugs), and cause the gun to become loose.

When oiling a shotgun, or, in fact, any firearm, only enough oil should be applied to lubricate the parts. There is much more danger in applying too much oil than too little. It is always best to purchase one of those very small oil cans from which only a drop appears when you press on the bottom of the can. Then, with a camel's-hair brush or a toothpick, work this well over the polished surface of the parts. The best kind of oil to use on all finely made arms is "watchmaker's oil." This is rather expensive—a single small bottle costs 25 cents; however, this amount of oil will take care of a good many firearms, providing you apply it properly. The cost is really not entitled to consideration because the oil is so decidedly superior to any other.

Be very careful not to handle the polished parts of gun locks with sweaty hands or allow these to lie about for a day or so before any oil is applied. It is always a good idea, when any parts are given a light polish, to have a cloth well moistened with gun oil and give these parts a good rubbing over. A jar holding an oily cloth should always be at hand for such purposes. Keep it covered so that no dust or dirt can collect on the cloth to cause scratches on some of the finely finished arms. It should be used freely upon any arms which are handled by different persons, for some have more acid in their perspiration than others, a feature which causes rust to appear very quickly and which can never be removed by simple methods. Very few men realize how much damage perspiration causes on a polished surface, particularly in the summer time, when this condition is at its worst. Very few students are inclined to take this precaution, but it is worthy of consideration if you are to be ranked among the best workman. Handling the parts with naked fingers is very likely to leave them in a condition that will eventually cause them to rust.

Now, to assemble the locks, particularly when the tumblers have been removed and where flat springs have been used. Follow previous instructions by placing all parts in the order in which they have been removed. As most flat springs have an extension on the end which engages the tumblers, many amateurs want to place them in the opposite way. On a number of guns this can be done, but when you want to cock the arm, strange to say, it does not work.

To assemble tumblers with flat springs is an easy matter in the padded vise, providing you have cut suitable blocks of wood to fit properly against the tumbler to compress the spring evenly in order to engage the pins or screws. A simple way to assemble these if you have either a small arbor

press or a drill press, is to compress the spring by placing suitable wooden blocks over the tumblers and exerting pressure on the spindle or ram until the pin engages the tumbler hole. As a rule, when an amateur removes tumblers and springs from a shotgun, he looks upon this assembly as a hopeless case; I generally have a number of such arms shipped to me in the course of a year with all the parts in a box, and frequently some parts are missing. Some alibis I hear are rather amusing, while others tell the truth. The old expression of how they collected the parts in a bushel basket is not far-fetched, altho I have never had them brought in to me in so large a basket. At one time, however, one arrived in a regular market basket; a market basket holds half a bushel, so we can consider the expression well founded with half its value.

Some shotguns such as the Ithaca, Parker, Fox, etc., have coil springs, and these are more difficult to assemble than the flat type of spring. Some have so much compression that I find the best method is to assemble such actions on the drill press, using the spindle as a ram. In assembling the action to the stock, care must be used in order to center the safety in the catch on the tang. When the trigger plate is set in place on the Parker, the safety lever is imbedded in the stock, and it is an easy matter to enter this by using a pair of tweezers, catching it on the under side and working it back and forth until the end enters the square notch in the under side of the thumb piece.

The majority of shotguns are simple to assemble, except those on which it is necessary to place the sears in position after the action is set in the stock. It is necessary to do this on the Parker, for on this gun the sear spring is in one piece sitting in a cut-out in the action. All that is necessary is first to press the sear down with the thumb until the pin enters, drive the pin through until it enters the other sear, and drive the pin in flush with the frame; then the trigger is ready to be assembled, together with the trigger guard. See that all screws are placed in position in the same manner they were removed and not pulled up any tighter than they were when taken out. On some shotguns the end of the sear which engages the triggers is turned too close, so that any additional tightening on the screws changes the trigger pull and sometimes will not allow the sears to engage the tumbler notch and may make the gun unsafe for use. At times this condition is so sensitive that when you fire one barrel the other jars off from the recoil, causing what is called a "double," which is not so pleasant to the shooter.

After placing the screws in position and before

the trigger guard is screwed in place, inspect the trigger for this fault. As you touch the trigger with your index finger there should be a slight amount of play between the trigger and the sear; not enough so that there is a movement of $\frac{1}{8}$ inch before it touches the sears, but only a little freedom between the two, say the thickness of a piece of paper. When you find these tight, or without play, remove the sears and file a small amount off the engaging off-set; then repolish the end. In other instances it requires the bending of the sear; this can be done providing it is soft half-way up to the end which engages the tumbler. A slight tap with a hammer and piece of copper is usually sufficient to bend them the required amount. The sear must be held in the vise in such a manner that you can measure or detect the amount the end moved, for it usually requires only a very small amount of bend to have the correct amount of play. At times you may have to assemble and disassemble two or three times until this condition is correct.

Single Triggers — The amateur should never attempt to do any work on single triggers unless he has had some mechanical training which will enable him to understand their working principles. I find that the most common defect is that the sear pressure is too great and does not allow them to function properly. The timing of the sears and tumblers on the single-trigger mechanism must be just so or you will find that one can be pulled off very easily and the other will not pull off, or vice versa. The simplest and best is the Lang; this any student can take apart and assemble with ease. The L. C. Smith or Hunter single trigger, together with the Miller, are rather complicated.

On the American arms and also some of British manufacture the greatest trouble is generally caused by single triggers installed in arms which have been changed from a double-trigger gun to a single-trigger. Such arms when sent to the manufacturer to have single triggers installed function perfectly at the factory. But after they have seen some service, they fall out of adjustment, frequently from a weakened stock or the changing of the wood in some manner. It is inadvisable to have single triggers installed in an old gun. The owner generally has more or less trouble from the time these are installed until he puts it away, disgusted.

Every shotgun having a delicate single trigger should be gone over once a year at least. If you own such an arm, oil it after each hunting season

to make sure that no water has penetrated into the working parts and caused them to rust. Then the gun may be put into the gun cabinet and you will know that everything is perfect for the following season.

Automatic Ejectors — As a rule these are very simple, especially those in American arms, and most of them are made with coil springs. Nearly all British and German types have flat springs which are made very carefully. I find that these seldom get out of order, and if they do, the sears need stoning so they will not be too sensitive. The flat springs are made very heavy in foreign arms, and they require a spring vise to disassemble them correctly. These and the forearm catch come under the same heading, as they are attached to the fore-end.

You generally find more trouble with the fore-end catch than you do with the ejectors, due to the notch being worn, or the fore-end not being deep enough in the stock and causing the fore-end to become loose. The fastening rod may be bent, and not allow the iron to bear against the radius on the action; the result is that you can feel a slight movement. Examine the fore-end to see if it has broken loose from the rib, for at times this happens and the owner is unaware of it. If such a condition exists, the rib must be sweated back in again and the finger fitted into the notch. Often the locking lever is too short; therefore, it must be lengthened so that the proper snap is given when it is set in place.

The student who is capable of becoming proficient in the art of gun work will require no special rules when assembling or disassembling a firearm. He will also be able to pass judgment upon the different makes of firearms, and he will readily distinguish the better grades. He will also know that a firearm fully finished in every particular is far better than one partly finished, the inside left rough, and all parts still showing heavy tool marks. Prompted by such consideration, he will seek the better arms and demand them.

You will find that it pays to know your gun and to apply the proper care. Year in and year out, it pays. Some arms are more complicated than others, but if you treat them all as delicate pieces of mechanism you will be working on sound principles. There is just one more warning I must give, and that is the undue snapping of a firearm without snap caps in the chamber. This is perfectly all right for some bolt-action rifles, but on shotguns and single-shot arms—never!

CHAPTER XXIV
Minor Repairs and
Adjustments

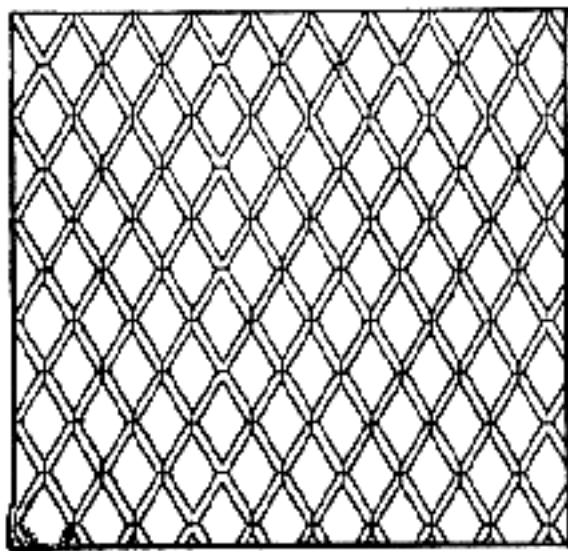

Minor Repairs and Adjustments

GOOD shooting is an art which requires the study not only of rifles but of ammunition as well. One can never expect to acquire perfection if he does not have some natural talent or capacity to grasp the fundamental and invisible operations of the arm he is using. Any man with a fair understanding of mechanics is capable of employing his best judgment in the use of tools and can become a passable mechanic, but without this peculiar natural inclination, which no one can clearly define, it is impossible for that person ever to excel as an expert. No matter where you go, you will find some men better fitted than others to solve problems pertaining to mechanics. I found in my past experience at the Arsenal in the small-arms tool department that there were very few men who could carry out the more exacting work on tools and gauges. These men were born mechanics, and the same inherent ability will be found in all lines of work, even in the higher professions. Craftsmen like these are not made but born. It is not often we meet with such men, for they are as scarce as true painters and true poets. When one does meet with such a man, one recognizes his ability almost immediately. I believe there is some peculiar balance in his makeup or organization; it is folly to envy such a person, and it is not worth while to brood over the question if such a peculiar balance did not fall to your lot. If you should wish to succeed, try a little patient study of your own shortcomings; apply determination, and practise on one subject until you arrive at perfection. Practise will at least bring you up to average, and that will leave no reasonable cause for complaint.

Every man who uses a firearm at all feels an ambition to use it skilfully. So when the average person, or even the expert rifleman, finds himself falling short of making good scores, he will often carry his difficulties to a gunsmith, but in a great many instances he can solve the problem himself.

Your best experience will come from shooting, however, and this part of the subject must not be brought down to the mere discharging of a firearm. The afterthoughts for the cause of this or that will release the priming charge, so to speak, and open up hidden or dormant mechanical ability. Testing a new rifle is like trying out a new car. There are

many minor adjustments to make. A new factory arm does not require as many as a custom-made arm, but to the crank there are a hundred and one obvious faults that must be corrected. A second-hand arm or an arm which has seen better days may perform a little better if the muzzle is remedied.

Removing a Muzzle — Because the muzzle of the .22-caliber barrel is particularly exposed to atmospheric conditions it is more susceptible to rust. Likewise, humidity has less action on the balance of the barrel, and consequently it is less troubled with that problem; that is, of course, unless the spots have spread until they encircle the entire barrel. In the event of the former situation, this difficulty can be remedied by cutting off the end of the muzzle about one-half or one inch. Very often this rejuvenates the gun, for the bullet then has its original perfect delivery at the muzzle, and accuracy results.

For the best results, the barrel should be cut off by means of a lathe, but the muzzle end can be, if necessary, removed with a hack-saw and then filed square. This process has been described in Chapter I, but you can advance still further, and do a much better job. When cutting off the muzzle it is essential to have it absolutely square, as the bullet must escape from the muzzle at a true and equal bearing; when one side is high and the other low—and this variance only requires a difference of 0.001 inch—you can never expect to obtain real accuracy, for the escapement of gases is greater at the low point, tending to tip the bullet in various directions. This is an established fact derived from experiments made at the Frankford Arsenal. For this reason, I have always tried to impress upon every one how essential it is to have the muzzle of any firearm perfect with the bore.

Assuming that you do not have a lathe in your equipment, cut the barrel off with a hack-saw and file the muzzle square. Clamp the barrel in an upright position in the vise. With a 60-degree countersink, break the edge of the bore to a depth of $\frac{1}{32}$ inch. If a small lathe is available, a counterbore with a pilot should be made. The reamer should have six flutes or more, or one as shown

in Figure 12. To secure the best results, the flutes should be stoned so that the cutting edges will not dig in or chatter when it is revolved. Here again I must impress upon the reader the need for a square muzzle. Suppose, for instance, that the muzzle is cut 0.003 inch off square, and there is a low and a high side. When the reamer begins to cut, even tho it is on a taper, the high side will always push the countersink toward the low side, and it will have to cut more off the low side than intended, particularly if it is one without a pilot. Of course, any reamer will follow a hole, but you will have different tools, which, you must bear in mind, are only cutting on the edge to a certain portion of its diameter, and the high point will always crowd the cutting edge against the low point, making it eccentric to the bore. By using the countersink, a part of the metal is eliminated for the lapping operation to follow.

Purchase various sizes of round-headed brass and wood screws. The round heads act as the lap. Start to lap with the smallest screw; chuck this into the hand breast-drill or brace, and with a small quantity of flour emery mixed with olive oil, cap the ball portion of the head into the countersunk portion of the muzzle. The caliber of barrel governs the size of the screw heads to be used. If, for instance, the barrel is a .22, you will use one measuring about $\frac{5}{16}$ inch, and so on, the heads always in proportion to the caliber. Continue to lap until there is a perfect bearing on the inner surface; if you continue the lapping operation too long you will have too great a concave surface.

A muzzle lapped by such a method produces very satisfactory results, and many old barrels can be given new life. If the muzzle of either rifle or revolver has been injured in some way, such as by dropping, it can be satisfactorily repaired in this fashion, only reversing the screw, using the angle on the bottom side and first cutting off the threaded portion.

When lapping out a muzzle in this particular manner, a "turning over" of the lands and grooves will be found which is better described as a burr. This must be removed by means of a stiff bronze bristle brush, or a patch wound around a bronze brush, and fine flour emery and oil. Much care must be used with the oil and emery so that the muzzle is not enlarged. The stiff bronze bristle brush is usually the only remedy required. It will be surprizing and satisfying to be able, by means of so simple an operation, to bring new life back into a rifle barrel; this can be done, provided there are no other faults more serious than the faulty muzzle of the barrel.

Poor Ignition — Inaccuracy is always first blamed on the ammunition, and not on some other cause; yet such cause may be in the mechanism of the rifle itself, particularly the end of the firing pin. Figure 142 illustrates ten shots fired from

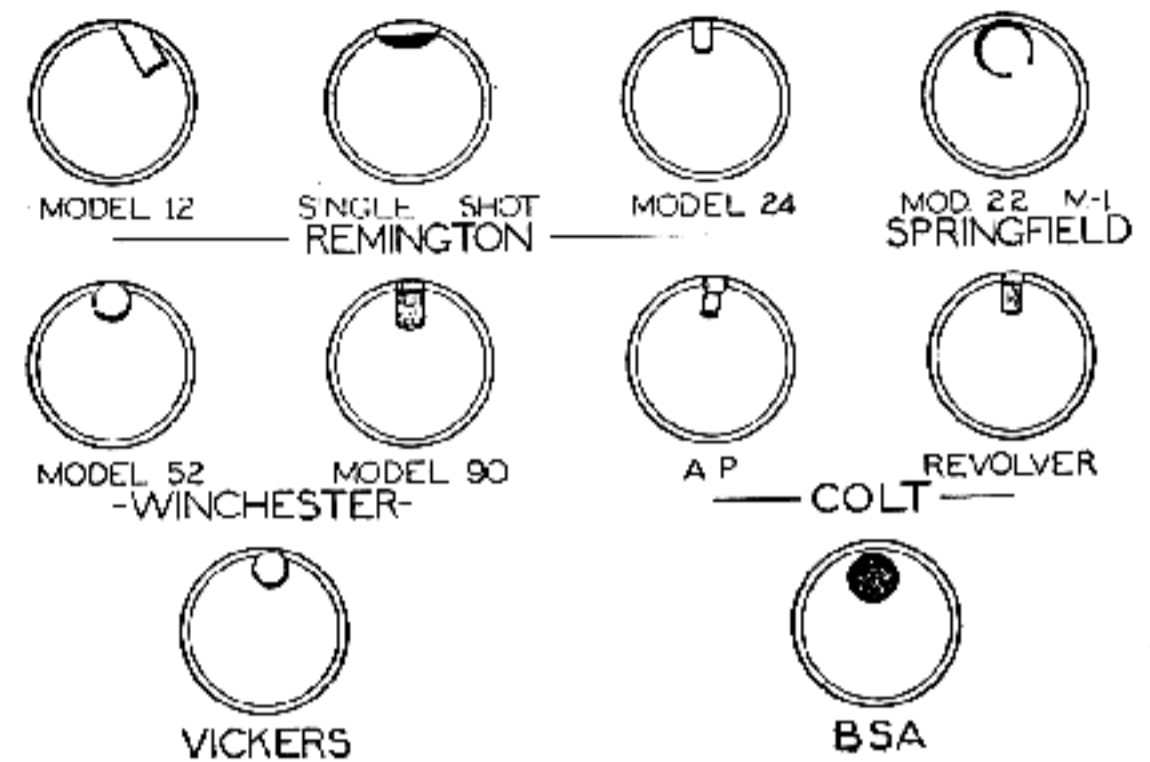

Fig. 142
Firing-pin impressions left on caliber .22 cartridge cases

different rifles and two side arms. The .22-caliber rim-fire cartridge must have a perfect support against the counterbored part of the barrel if it is a single-shot action, or a perfect support against the face of the barrel if it is a bolt- or slide-action arm. On single-action arms you will usually find the greatest offenders in firing pins, extractors, poorly counterbored chambers, too great a space between barrel and breech block, the chamber rounded too much at the end, the counterbore too shallow, breaking the primer mixture when the breech block is forced into position, etc. To have the correct ignition in a .22 rim-fire cartridge, it must be remembered that there is only one correct spot for a firing pin to strike, and that is at the top of the head of the case; consequently, when the blow is struck there should not be any cushion effect, but a solid foundation with correct head-space.

In such a case the fulminate in the rim is strictly localized, and the firing pin must hit it in such a manner that it will receive instantaneous ignition when the pin hits the rim. The firing pin and spring are also sources of continual trouble, the firing pin in particular. In order to secure correct and positive ignition in a .22 rifle the firing pin should be perfectly flat upon the face, and the diameter should be governed by the force the spring or hammer is capable of making upon the rim. The impression of the firing pin should be deep instead of light and shallow. The Model 52 Winchester will sometimes refuse to shoot. Examine the firing pin and see if the projection is correct. If not, you will find this pin set back and

the face at a slight angle. When this is found to be the case, disassemble the bolt, remove the firing pin, and lengthen it by peening it out; this can be done with a light hammer and by holding the striker on a hardened piece of steel set in a vise. Do all the peening back from the point or between

of ammunition; the main cause is usually weak firing-pin springs, or the firing pin binding in the firing-pin hole, due to upsetting or retarding the blow to such an extent that misfires take place.

Study Figure 143, showing, in three different cases, correct ignition at the time ignition takes

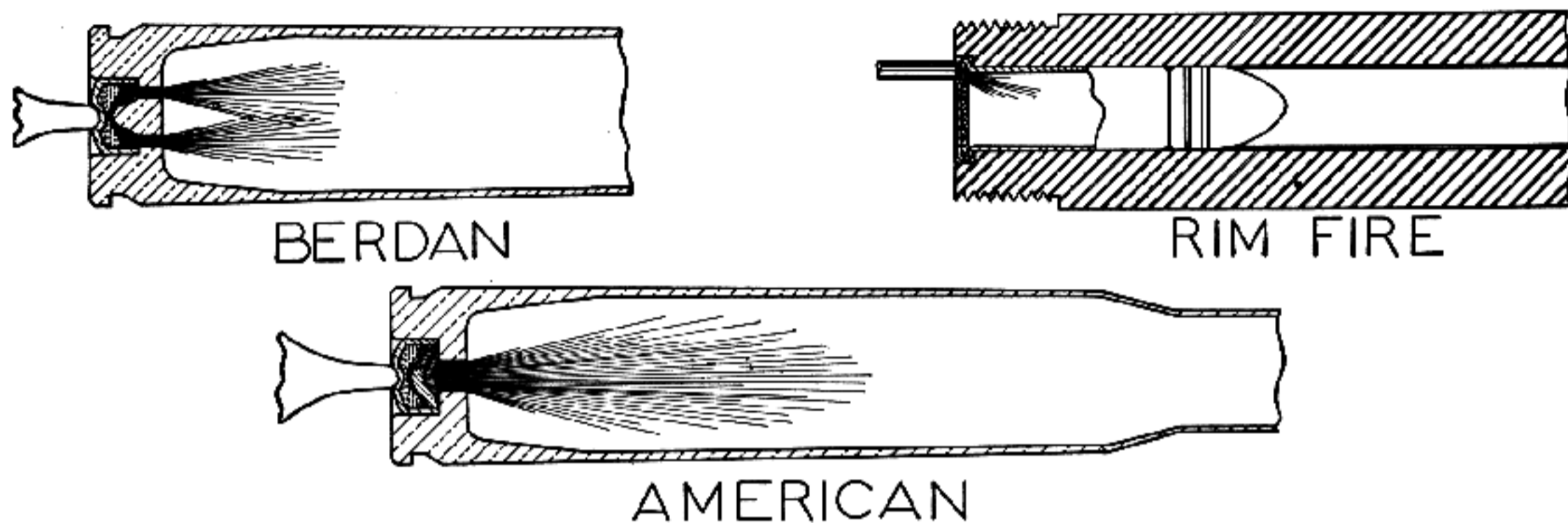

Fig. 143

Primer flashes showing how propellant is ignited when the firing pin hits the primer

the point and the spring shoulder, where the angle comes in, up to the round or small part. Throughout this operation, frequently try it in position to see how much it has been lengthened; also keep it straight so it will not be retarded by binding on the sides. When it has been lengthened to the desired distance, file at right angles with a fine needle file and stone the face to remove any file marks. Assemble the bolt again and test it on the range and you will be surprised to see its accuracy. This operation has eliminated the dropping of one or two shots that could never be accounted for, and the slight change has worked wonders.

The same trouble is often experienced with the Springfield, caliber .22. You will notice in Figure 142 the indentation left by the striker on the rim of the case. At times the face of one of these strikers becomes very rough from the continual hitting upon the rim or from other causes. Stone the face at right angles and make sure that it has the proper projection; if not, it is better to send for a new striker rather than take the chances of lengthening it.

Do not lighten any cocking pieces, firing pins, or strikers, believing that you will secure faster lock time. Instead of lightening these parts, work in the opposite direction and try to see where it is possible to eliminate friction by stoning the hard bearing surfaces on the parts. The primer must receive a quick crushing blow to obtain immediate and instantaneous fire from the primer mixture, whether center- or rim-fire cartridge. Misfires are not always caused by primers except in certain lots

place upon the blow of the striker. In the rim-fire illustration, the striker is not always at the top as on many of the old-style single-shot actions, in which a number were at the bottom over the extractor. The proper position is at the top and should be there in all target arms if proper ignition is to take place. Study the Berdan primer and European cartridge, also the American design of cartridge case. We would very likely choose the American design, which shows a greater amount of flash in the illustration, but in reality both are about equal. The Berdan primer is the best, including the design of anvil in the primer pocket which is solid; in our American primer we have a separate unit in the primer cup in the form of an anvil, and the manufacture of this type of primer must be very exact in order to obtain perfect ignition. The foreign design, having the anvil in the base or primer pocket of the case, gives a solid foundation for the striker to hit and does not rely upon the anvil as in our primers; therefore it has a much more sensitive primer when hit by the striker.

To obtain the best results with a firing pin or striker on these forms of primers, the pin should be made at the point, as illustrated by Figure 144, with a projection of 0.065-inch maximum and 0.055-inch minimum, with the end always highly polished and free from scratches or tool marks. Do not try to change any of the parts in the design of strikers, cocking pieces, etc., to lighten the firing-pin mechanism, for such a primer requires a very hard blow and any alterations are dangerous.

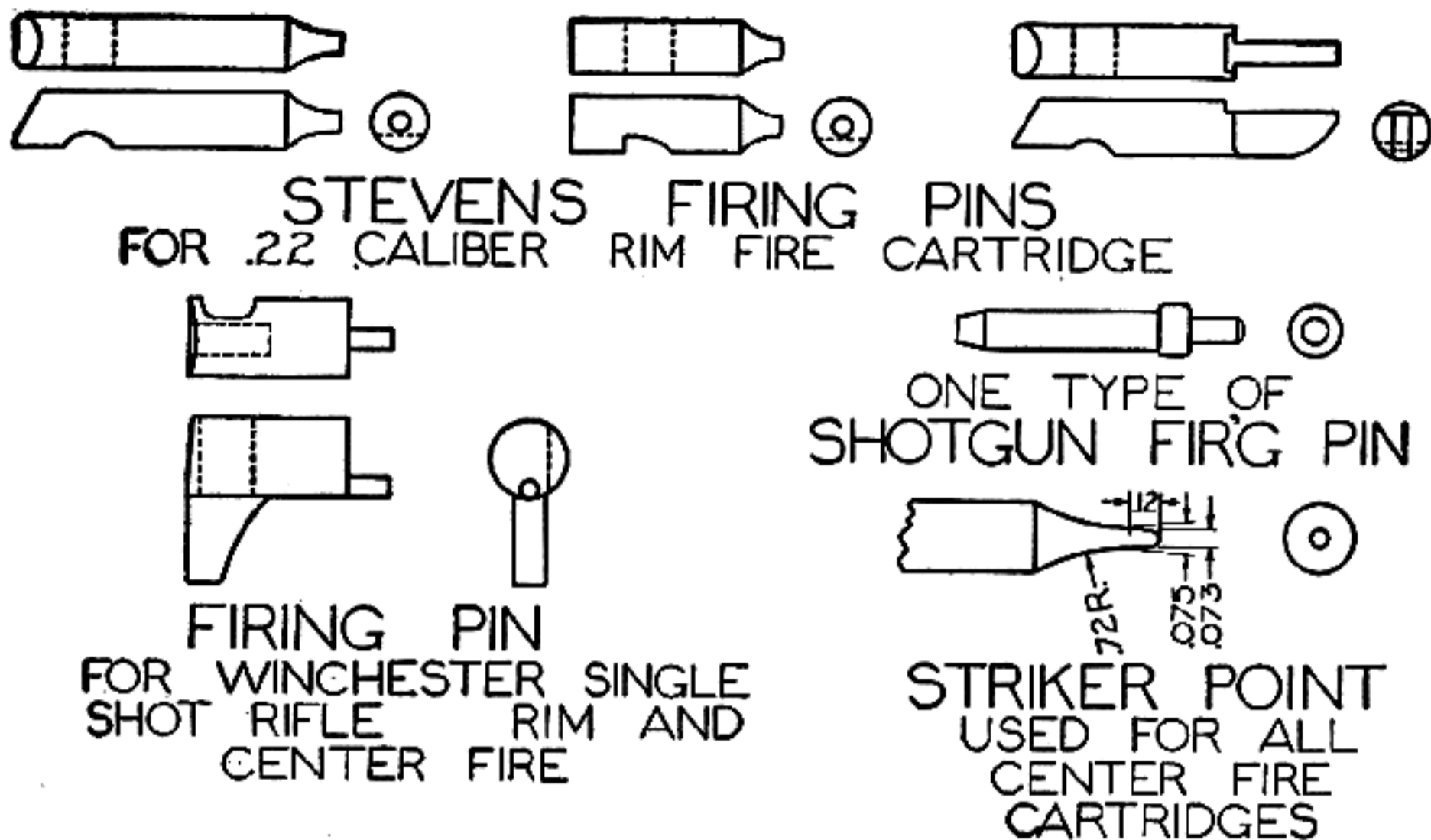

Fig. 144
Types of firing pins

The foregoing are the usual troubles revealed upon testing a rifle, barring bad trigger pulls, sights, poor extraction, free working bolts, etc. The main object in testing is to gain the necessary practise to be able to solve the various difficulties; this practise will lead in time to a perfect understanding of firearm principles.

Alterations on Winchester Single-shot Action — Changing a single-shot action from rim fire

to center fire can be accomplished without the change in the firing-pin hole, a change which is usually done by bushing the block and making a new firing pin.

Figure 145 illustrates the Pope design of an eccentric lever pin which makes it possible to change from rim fire to center fire without altering the block. If the correct sizes are to be had for one of these eccentric pins, those who are about to make such an alteration will find it a sim-

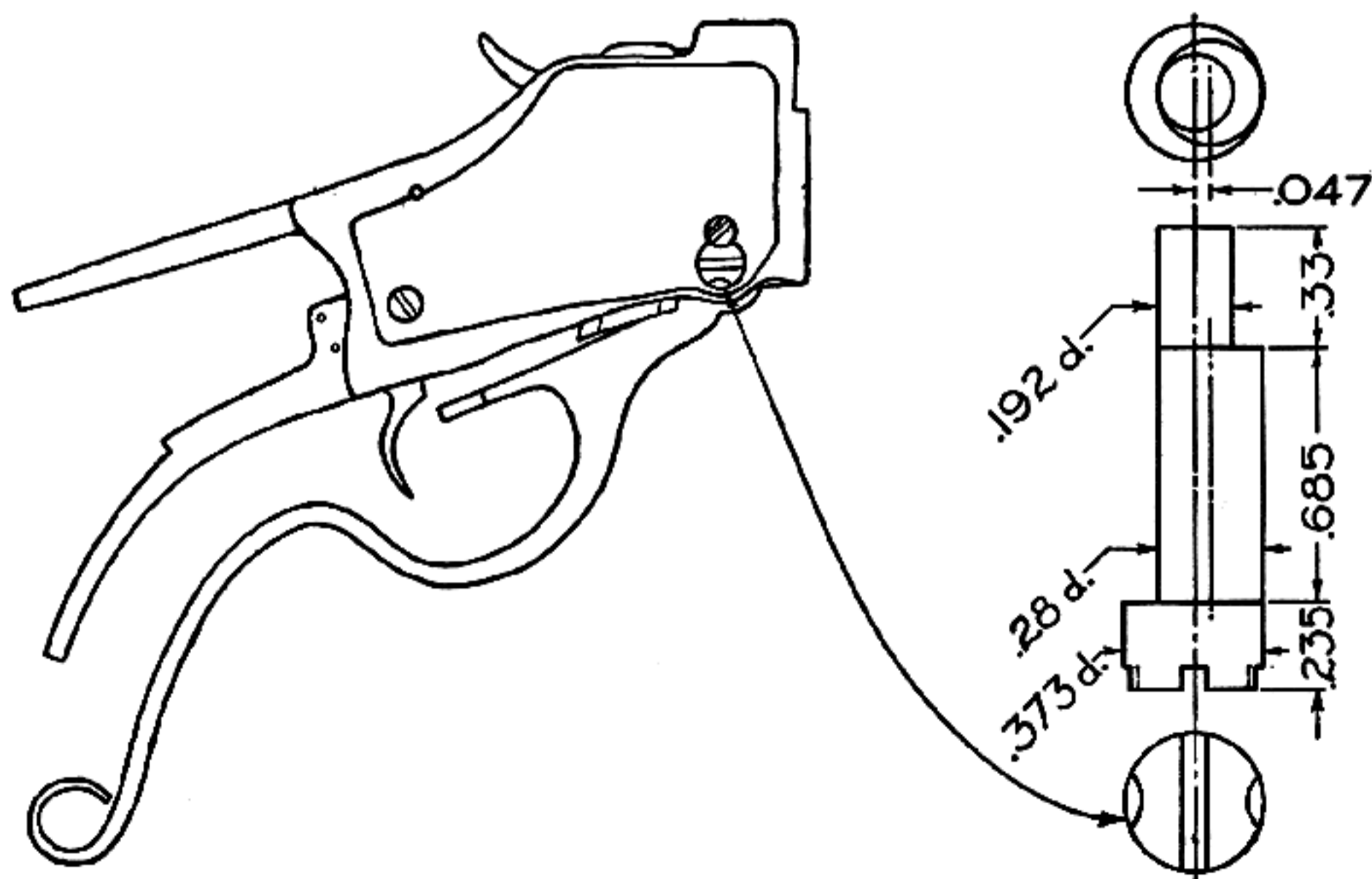

Fig. 145
Eccentric lever pin—Pope design. When two barrels are used on the same action this changes rim-fire cartridge to center-fire

ple matter. Any one having a lathe and drill press can make one of these. Make the pin first and do the necessary drilling and reaming on the action and under lever so the pin will fit without any lost motion. A keeper screw holds the pin in position. By making half a turn on this screw or coming into the open position it is possible to give the eccentric screw a half turn to bring the block either up to the required distance for a center fire or to the lower position for a rim fire. The change of the under tang and lever has taken place on this particular rifle and Chapter XIII, Volume II, gives a brief account of this work. This illustration shows the correct layout, so it will be an easy matter to copy the idea. You will notice that an extra piece has been welded to the end after it has been bent to form the pistol grip and then the end curled in order to have a knob on the end for a better finger hold. It is an easy matter to bend all Winchester under levers and weld this extra length to the forged end, but on the Stevens actions this cannot be done, for they are made from malleable iron, and if you attempt to bend by heating as for the Winchester, they break off; it is best to let these actions alone unless they can be cut off and an extension welded on the end to the form desired.

Alterations on Martini Action — The next action to be considered in changing from rim fire to center fire is the Martini action for any center-fire cartridge, particularly the .22 Hornet. This action is one of the most simple to change. The operation should be done very gradually, not removing too much metal at one time; and great care should be taken in order that the altered shape of the horns will not pull the block away from the face of the barrel. Should the block be pulled away from the face, a thread should be removed or the shoulder turned off until it makes one turn, to compensate for the distance between barrel and breech block.

A barrel-center testing rod should be made which will just pass through the bore of the barrel. The end is faced off square and on this is placed a film of Prussian blue. Every time a small amount of metal is removed from the horns, the face of the block should be spotted until the correct center is obtained. After bringing the block down so that the firing pin comes in the exact center, a new firing pin must be made from chisel steel with the correct contour on the end, as Figure 144 illustrates.

Springfield .22-Caliber Bolt Stop — When the Springfield Armory designed the .22-caliber rifle they used the Model 1903 receiver for reasons of economy and to give the rifleman the same feel of rifle as with the .30 caliber; it was made possible

to change from one to the other without the trouble of becoming accustomed to a different arm. They overlooked one point in the design which could have been included very easily, and that was placing a bolt stop in a position so that it would not be necessary to have the long bolt-throw now required, which allows the bolt to come back and usually hits the shooter on the nose.

To allow only a short throw of the bolt, all that is necessary is to drill down from the top of the receiver on the left side with a $\frac{5}{32}$ -inch drill and insert a pin. First draw the bolt back until it has sufficient clearance for the magazine, and drill the hole in such a position that the ejector lug will come against it on its travel to the rear. The pin will come close to the inside walls of the channel and allow correct clearance for the bolt.

The manufacture of a pin for this is a simple lathe operation. A knurled head is made to a diameter convenient for the fingers to grasp when necessary to remove it. On the bottom of the pin a circular groove is turned, as the pin will come on the outside of the magazine. A small spring is fastened to the side of the magazine so that one end will slip into the circular notch, which will cause enough friction to keep the pin from falling out; and when it is necessary to remove it the small amount of friction will not be enough to require any effort. By the use of this pin the cut-off can be removed entirely, for it will never be used again.

Screw Positions — After the constant reference made to screws being placed north and south, it is well for the reader to have a thorough understanding of these terms. The position of a screw slot should always be parallel with the length of a fire-arm. By way of illustration, if the guard screws in a Springfield rifle are placed crosswise or at an angle of 90 degrees, which would be across the narrow part of the guard's tang, the appearance would be rather conflicting to the eye and better judgment; but if they are placed lengthwise, or have the slots of the screws so placed that they face fore and aft, they will be what we call "north and south."

Many times it is impossible to set screw slots in this position on military arms, but when restocking one of these rifles it can easily be done with all screws, particularly the new screws used on butt plates, pistol-grip caps, etc. By having a full gross of wood screws it is always possible to find some which when set will have the slots in the heads pointing in the desired direction. It may be necessary to try a good many, but there is always one among the lot which will properly tighten the part

in position and still point north and south. If new screws are being made for any particular part it is very easy to fix the position of the slots correctly, for their locations can be marked on the heads, and after the screws have been removed they can be slotted according to these marks and the head finished to the desired thickness.

Many screws require anchoring screws similar to those seen on a Browning Automatic shotgun, on the outside of the action. Whenever such a screw is to be used to hold the main screw, it is well to drill and counterbore this in the position of north and south, except in cases similar to Figure 145. The best location for a Pope eccentric pin would be on the top, for the pin denotes the position of the top or bottom cut-out. Anchoring screws are only applied in certain instances where it is necessary to prevent an essential main screw from turning, as on the military guard screws in single-shot Colt revolvers, etc.

Height of Sight— There is only one satisfactory means by which to secure the correct height of a sight while testing a rifle on the range. You may have made a new ramp and wish to know the correct height for a front sight. To ascertain the accurate height of the sight when attached, first solder on a temporary sight of soft solder, and file it to the shape of a sight. The temporary sight is attached to the tip of the ramp and then filed to the width you think correct; but make it high enough so that it can be dressed down. While on the range, set the rear sight down as low as possible and shoot the rifle; then file down the lead sight until the proper elevation is secured. Windage adjustment may be disregarded in many instances.

After returning from the range, measure with calipers or a micrometer to the bottom of the barrel or ramp band. From this subtract the over-all dimensions of the front sight from top of bead to bottom surface of base. Set the hermaphrodite calipers for the new measurements, and scribe on

front end of ramp. This mark should be laid out on both sides of the ramp, the marks on each side representing the depth of the dovetail cut, and measure the thickness of dovetail base of the sight. Scribe a line above the first one made on the sides of the ramp. This gives the top surface of the ramp. Remove the top section and mill out the dovetail slot for the sight. When fitted, the top of the sight bead will be almost the same height as the lead-sight blade. There will be, of course, a little inaccuracy, which may be taken up with the rear aperture-sight adjustment. If it is a leaf sight, set it a trifle lower so that you can file out the leaf upon the second visit to the range.

Various heights of sights may be procured from the manufacturer. The approximate height should be first determined with the lead sight as above described, and then the design selected that is most suitable for the purpose intended. The set-up in a milling machine and the use of a dovetail cutter is the most satisfactory method of setting a sight in a ramp. Of course, the sights which are placed in sideways can be filed in, but the use of a caterpillar sight requires a set-up in the milling machine. The caterpillar sight may be a driving fit in the slot with no other means of holding it in place, or it may be filed off on the sides or bottom to an easy sliding fit, and then a plunger fitted to it as described in Chapter XIX, Volume II.

By carefully following the instructions in this chapter and Chapter XXIII, the student who is just beginning to carry out work of a nature that does not involve a great amount of tool equipment should not encounter very much difficulty. The best way to start is by firing a rifle on the range in order to arouse one's enthusiasm, and then start working on an old arm; not necessarily a worn-out weapon, but one that has possibilities and can be put in order. Form mental pictures of what the arm is capable of, and finish it according to your ideas.

From such a humble start the road to success will be much easier.

CHAPTER XXV
Miscellaneous
Formulas and
Methods

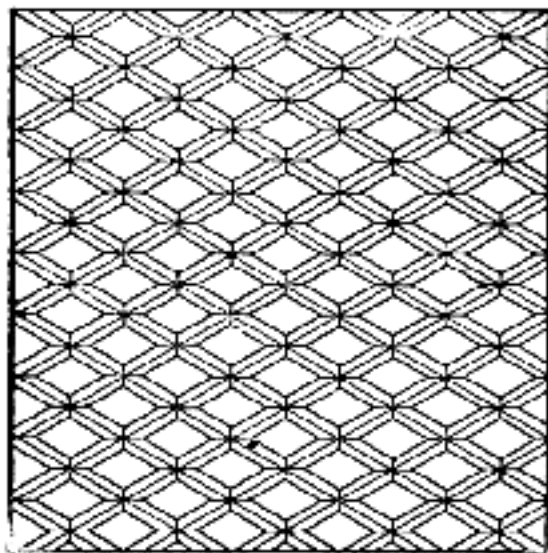

Miscellaneous Formulas and Methods

THIS chapter is written with the intention of giving the beginner formulas for various oils, solvents, fouling solutions, etc., which are of particular value and interest in gun work. I shall also endeavor to offer suggestions and ideas which will enable the novice (whom I am keeping primarily in mind) to help himself, and at the same time impart to the died-in-the-wool gun crank new points of interest which he has not found elsewhere.

I know that many will immediately anticipate formulas for the mixing of explosives, for I have been asked time and time again for such information through correspondence. When I receive such requests, I am reminded of the old saying: "He therefore took to fulminating powder, like a wife—'for better or for worse,'" and I am of the opinion that such adventures usually lead to "worse."

You will find that gum shellac is a constant friend in time of trouble, for it is one of the best materials to be used in making fillers for various woods. If there are cracks or checks in the material, or if, in stocking, a slip of the tool should occur while letting in a receiver, guard lock, or any other part, a little of the gum judiciously applied often remedies the defect. Like charity, it covers a multitude of sins.

Wood filler or plastic wood is very often prescribed for filling in cracks, checks, etc. However, such advice is erroneously given, for altho this material is satisfactory for filling up pistol grips on revolvers to fit the shooter's hand, it cannot be used successfully for filling in checks and cuts in and around metal parts. The only really effective material is the following:

Gun Maker's Shellac — The amount given in this formula will last a long time:

12 oz.	shellac (seed lac)
4 "	rosin
8 "	alcohol (pure grain spirits)
1 "	turpentine

Place the shellac in a clean receptacle and add the alcohol. While the gum is dissolving, keep it covered to avoid dust or dirt, and let stand in a warm place. If it coagulates in the alcohol, stir frequently so that the alcohol will completely dis-

solve the lac. In a separate receptacle place the rosin and turpentine and allow the latter to dissolve the former completely. Add these two mixtures together, place over an alcohol lamp or Bunsen burner, and allow the ingredients to mix completely. Care must be taken when boiling, as too much heat may cause the mass to catch fire. The heat may be continued until the mixture reaches the consistency of a heavy paste, then it should be poured into moulds in the form of sticks. These are convenient in handling and applying on the parts requiring shellac.

When blemishes are to be concealed in the wood work or a bad cut-out has been made in stocking a rifle or shotgun (an accident which often happens to both the beginner and the experienced man where receivers, guards, actions, etc., are let in), melt a piece of gum shellac into the place with a warm iron so that it will be well filled. It is also well to warm the wood or steel where the gum is to be applied, to make sure that it will run down and make a good adhesion. Let it remain about ten minutes until it becomes solid, and you will find it difficult to detect the place where it has been used. A proper application requires the eyes of an expert to discover its use in wood work.

Gun Oil — The fact that there are few oils fit for gun work does not seem to be commonly known, for you will find arms coming in for repairs so badly gummed up that only special treatment can get them apart, especially when linseed oil has been used as a lubricant. This is done rarely, but it is surprizing to learn just what oils are used by gun owners.

The finest oil to use is the best quality of sperm oil. This comes in a liquid form and is extracted from the head of the sperm whale. As much as seventy barrels are found in a large whale. This is not only used for lubricating purposes, but on any occasion where an oil that is free from acids is required to hold a body. Any fine animal oil may be used as a substitute, particularly the oil from the jaw of a porpoise. Such oil must be prepared by the clarifying process which I shall describe later. A good oil should never be thinned or "cut" with kerosene, gasoline, benzine, or any

inferior oils, as this reduces its wearing quality. The oil should not thicken with exposure to such cold as we experience in our northern climate.

As a rule, vegetable oils are unfit for any lubricating purposes on firearms. Castor or linseed oil will gum up and bring about extremely unpleasant results. The only vegetable oil which can be used when mixed with sperm oil is pure white coconut oil, and this but sparingly. Olive or "sweet" oil has very often been agitated with common salt, nitric ether, sulfuric acid, and even hydrochloric acid to keep it from becoming rancid. This oil is totally unsatisfactory, for it not only has a bad lubricating quality, but will rust and spoil any gun parts to which it is applied.

The preparation of the most satisfactory gun oil is as follows:

16 oz. pure sperm oil
1 " pure coconut oil.

The coconut oil becomes heavy in cool weather, but during summer heat is in a liquid form. If it is thick, place it over the gas flame or some other form of heat, and warm both oils together. Allow them to simmer between five and ten minutes; the degree of heat should be about 200 degrees Fahrenheit, just enough heat being applied so that the oils will be agitated in the receptacle, without any great amount of odor rising. Turn off the heat and let cool; it will then be ready for the clarifying process.

When you desire to clarify oil, take a block of pure lead and file off about half a pound of shavings with a vixen file or a wood rasp, or better still, if you have a shaper, cut these off in the same manner as you would a piece of steel. Place these lead shavings in a two-quart bottle and then add the oil. In time the impurities will collect on the lead, and the clarified portion may be poured off. During this process let the bottle be exposed to the sun for two or three weeks or even longer. You will notice that the oils have different bodies in the morning before the sun has a chance to effect the entire mass. The top portion must be poured off and filtered through filtering paper. This portion is used for the fine lubrication of locks, etc. The second portion is also filtered and used for coating the inside of rifle and shotgun barrels, and wiping off the exteriors of firearms to protect the metal parts from rust. The congealed or heavier portion on the bottom can be warmed, filtered, and used not only for the inside of barrels, but the outside as well, when the arms are used in a warm or tropical climate. These three oils should be placed in bottles and labeled Nos. 1, 2, and 3, with suitable inscriptions so that they will be known by anyone having occasion to use them.

Gun Grease — All wool in its natural state contains fatty or greasy matter called "suint," secreted by the skin and covering the individual hairs. When this is separated from the wool and refined, it is called "lanolin" and can be purchased at any wholesale drug house. The lanolin is too heavy to use alone for the bores of rifles and shotguns, therefore it must be mixed with "Rust Veto" or "white vaseline," the former made by E. H. Houghton Co., Philadelphia, Pa. A formula which has proved very successful is prepared in the following manner:

1 part anhydrous lanolin
1 " pure white vaseline or 1 part rust veto

Melt the two ingredients together over an alcohol lamp or Bunsen burner until they are thoroughly mixed, and allow to cool.

Lanolin in its natural state also serves to lubricate and make outdoor clothing waterproof. The wool in all garments eventually loses this oil, but an application of lanolin will prevent the fibers of the wool from becoming dry. After an application, it is surprising how waterproof old wool clothing becomes.

Gun grease is used when it is necessary to place arms in storage for a great length of time. When in a damp climate or near salt water and air, a liberal amount should always be used, especially on arms that are carried on board ship. Rifles should be disassembled and a liberal amount used between the wood and metal to protect the parts from the action of the salt air and water. In the dryer climates, No. 1 gun oil is all that is generally required except when a firearm is placed in storage for a long time. Those who wish a gun grease of a lighter consistency, may add sperm oil to the above formula until the entire mass becomes liquid.

Miscellaneous Lubricants — Various oils are so often mentioned in these pages and are used so extensively in the manufacture of firearms and ammunition, that it is well to have an insight on this subject. The demand today for better automobiles and machinery of all kinds naturally means that their lubricants must be of the best.

Lubricants are derived from minerals, vegetables, and animals. Nearly all the mineral lubricating oils are obtained from petroleum, altho some are derived from shale. Mineral oils are classed commercially as "pale" and "dark." The pale oils are somewhat transparent and tinged with a variety of yellowish and reddish shades; the dark are opaque and either greenish or brownish black. The specific gravity of mineral oil usually varies from about 0.860 to 0.940 and the flashing point from 300 to 600 degrees Fahrenheit. The oils obtained from

petroleum have a much wider range of viscosity than the "fixed oils." The thinnest are more fluid than sperm oil, and the thickest more viscous than castor oil. The shale lubricating oils are of a low viscosity.

Fixed Oils and Fats—Fixed oils are so named because they are not volatile without decomposition. They are obtained from the seeds or fruits of plants and the tissues of animals. All fixed oils become fats at low temperatures, and inversely, all fats become oils at 150 degrees Fahrenheit. The most common lubricants among animal oils are tallow, lard, neat's foot and sperm oil, and among vegetables, olive, rape, and castor oil. Ordinarily animal oils are either colorless or yellow, whereas vegetable oils are various shades of yellow and green. The specific gravity of fixed oils varies from 0.879 to 0.968 at 60 degrees Fahrenheit. Sperm oil has the lowest viscosity and castor oil the highest.

Brown or Thickened Oil—Lubricants of this class are fixed oils (usually rape or cotton-seed) which are artificially thickened by forcing a current of air through the heated oil, a process which increases the density and viscosity. Brown oils mixed with mineral oils are very largely used as lubricants. The mineral oils used for this purpose are usually of rather low viscosity.

Rosin Oil—This oil is obtained from common rosin by distillation, and is not suitable for the lubrication of machinery, but is used to adulterate mineral and other lubricating oils.

Soap and Grease Lubricants—Some mineral oils are thickened artificially by the addition of such a substance as aluminum soap. This increases the viscosity, but its effect diminishes rapidly when the oil is heated. Mineral oils are also thickened with sufficient soap (such as lime, soda or lead soap) to form a grease at ordinary temperatures. These greases may also contain some solid lubricant, such as graphite, talc, etc.

Adulterants—Many of the more expensive oils, such as sperm, olive, and lard, are adulterated with cheaper fixed oils and mineral oils. Cotton-seed is often mixed with lard and olive oils, and sometimes substituted for the latter. The use of adulterants in order to increase the viscosity is usually resorted to in the case of mineral oils. The presence of the adulterants can sometimes be detected by comparatively simple tests. Oils used in gun work must be pure and free from adulterants and acids.

Testing Oils—The quality and proportions of some lubricating oils can be determined approximately, without the use of any special testing apparatus, by the following simple methods. To determine the presence of solid impurities in the oil, kerosene is added to half a tumbler of oil until

the whole becomes quite thin. This mixture is then passed through filter paper or ordinary white blotting paper, and after all the oil has passed through, the paper is washed with kerosene. The residue on the paper, if any, will show whether or not the oil had any solid impurities. Impurities may also be roughly detected by smearing a piece of writing paper with oil and holding it against the light. If the oil is free from solid impurities the blot will be equally transparent throughout; otherwise, the solid particles will be visible. The oil must not resinify. To test it this way, pour it into a shallow dish and leave in a warm place about a week. There should not be the slightest crust at the end of that time. Another way to test oil is to mix it with the fumes of nitric acid. If the oil is pure, a thick mass will form in a few hours, while resinifying oil will remain thin.

Acids are very injurious impurities in any oil used for gun work, since they attack the parts lubricated. To test for acids, copper oxid or copper ash is added to the oil in a glass vessel. Acid-free oil retains its original color, while acid-impregnated oil becomes greenish or bluish. Another test is to drop the oil on a sheet of copper or brass and leave it there for a week. If the oil contains acid, there will be a green spot on the metal.

An oil must be greasy in order to have good lubricating qualities. To determine which of several oils is best, place a drop of each kind on a smooth, slightly inclined metal or glass chute. The drop of the best oil will travel farthest in a given time.

Powder Solvent—An erroneous belief exists that it is possible to combine a gun oil with a solvent, making the one do for two operations, and this usually results in a ruined barrel. There are also a great many men who are under the impression that when they use clean-bore ammunition or ammunition with the new non-corrosive primer, their cleaning worries are over. Many come to me with ruined barrels because they have neglected cleaning them. This applies not only to the .22 caliber, but others as well. These men come in with their rifles to have the bores examined, saying, "There is something wrong with that barrel; it doesn't seem to hold the shots on the paper any more, yet I am holding it in the same place all the time." Upon examination, I usually tell the owner that it has not been cleaned since the last time it was fired. Invariably I receive the answer: "Why, it isn't necessary to clean a rifle nowadays. I always use clean-bore ammunition." After running a bronze bristle brush through and cleaning the bore out thoroughly, I discover, of course, that the

barrel is ruined, yet it is difficult to convince the owner, for his faith is strong in clean-bore ammunition, regardless of climatic conditions.

As we know, it is typical of many American manufacturers to advertise products regardless of their merits. Large bill boards confront us at every turn and their talking points become slogans. "Clean-bore ammunition" is one of these. As a consequence those who are susceptible to advertising ballyhoo accept the idea that the disagreeable task of cleaning a firearm is over. This is perfectly all right in a hot dry climate; there a firearm can be forgotten; but in a moist climate such as we have near the Great Lakes, the owners of firearms are often greatly surprized to learn that it is still necessary to use the customary cleaning rod, powder solvent, and gun oil.

The following formula is very good for dissolving powder residue:

100 cc. best grade turpentine
100 cc. pure sperm oil
100 cc. acetone

Mix in order given and place in a glass receptacle with a glass stopper, so that none of the acetone can evaporate. If you wish to color the solvent, place a little alkanet root in the turpentine and allow it to stand for an hour or so until enough of the red color is extracted. If a darker shade of red is required, allow the alkanet root to simmer gently in the turpentine over a gas burner or an alcohol torch. Then strain or filter the turpentine and add it to the sperm oil and acetone. The addition of the alkanet root is not of any material benefit, but adds a rather pleasing color.

After a rifle is fired and before it is put away, it should be cleaned with a powder solvent to dissolve any residue left in the barrel, wiped out perfectly dry, and gun oil applied to protect the interior as well as the exterior. This only requires the use of a chamois or cloth well moistened with the gun oil. Moist hands are as harmful as climatic conditions or residue left in the interior. To use the solvent, saturate a bristle brush and work it back and forth through the bore. Then use clean canton-flannel patches to thoroughly clean and remove all traces of the solvent, for any of this left in the barrel will dissolve oil, and expose the metal to the action of rust through moisture.

Many shotgun barrels are ruined by lack of proper cleaning methods, and many shotgun owners will be surprized to learn what a lot of good is done by swabbing out the barrels with the powder solvent, which removes more residue than they ever dreamed could adhere to the interior. Most owners use a dry rag through both barrels and then place

some of this oil on a cloth and push it through, the result being—in a week's time or less—the complete evaporation of the oil with patches of rust showing, which can only be removed by a lapping process. When this happens to a rifle it means a ruined barrel, for it cannot be removed by lapping as in the shotgun.

Metal-Fouling Solution—The gunsmith is often called upon to remove metal fouling from the bores of high-velocity rifles. This requires a special process—a very simple one when understood. Such fouling consists of patches of metal left in a rifle barrel from the jackets of bullets, particularly when bullets having jackets of "cupro-nickel" have been used. This metal is fast disappearing in the manufacture of jacketed bullets in the United States, but in England and Germany they still use the cupro-nickel bullets. The present manufacturers of bullets in this country use a gilding metal or an alloy of copper. Some are made with the pure copper, which is rather a soft material. The gilding metal, as used by the Frankford Arsenal for the manufacture of the National Match ammunition, is a much harder alloy, gives better results in accuracy, and reduces the problem of metal fouling to a minimum.

To determine the presence of metal fouling in the rifle bore, first clean it with the powder solvent and then thoroughly clean and dry the bore by using clean patches. Examine from both the muzzle and chamber ends by holding it in a good light; the presence of metal can be detected in different forms such as long streaks, small flaky spots, or even lumps and smears adhering to the lands and grooves. When any such condition exists it should be removed at once, for it will interfere with accuracy, and if left long enough, rust will develop under these patches and in a short time the barrel will be ruined.

The metal-fouling solution is compounded as follows:

220 gr. ammonium persulfate
100 " ammonium carbonate
90 cc. ammonia (26 to 28%)
60 cc. distilled water

The first two ingredients should be powdered together in a small mortar and then mixed with the last two in a bottle with a rubber cork. Secure a bottle large enough so that when you pour in the two latter ingredients it will only be one-half or two-thirds full, for the solution generates a powerful gas which may blow the cork out or burst the bottle. Keep it in a cool place when not in use. This amount of solution will keep between two and three weeks; after that, it generally loses its

original strength, so that it is far better to mix new as your requirements demand. Always keep the bottle tightly corked when not in use, and leave it uncorked only for a few seconds when pouring out the amount required.

When ready to use the solution, carefully clean the bore of all oil and grease. Then insert a rubber cork in the chamber, and a small piece of rubber hose over the muzzle. A convenient length to use is about 2 inches, making a watertight joint. Stand the rifle in an upright position, with the barrel vertical. A practical method is to rest the muzzle on the floor and clamp the other end in the vise between felt jaws.

Carefully pour the solution through the rubber hose into the muzzle of the rifle until the bore is full and the liquid flush with the end of the barrel, being very careful not to spill any on the outside of the rifle. If this should happen, wipe it dry at once with a cloth well moistened in gun oil. Let the solution remain in the bore between twenty and thirty minutes, but never more than half an hour under any circumstances. When first poured into the bore the liquid is as colorless as water, then little bubbles begin to appear and it assumes a deep blue color as it begins to dissolve the alloy (which is mostly copper) deposited by the bullet jackets. It generally completes the work in fifteen minutes, but the full thirty minutes will remove every trace of fouling.

After the solution has performed its work, reverse the rifle muzzle, and pour out. While in this position, take the rubber hose from the end of the muzzle and insert a cleaning rod to remove the cork from the chamber. Keep the muzzle down all this time so that none of the solution will enter the chamber and mechanism and promote rust. From the chamber end, run a clean dry patch through to remove any trace of the solution left in the bore. Then place the rifle in a vise and run a number of patches through to remove the last remnant of the mixture before it has had time to evaporate on the steel. The best method for this operation is to take a cleaning tube and funnel, pour hot water through from the breech, and then thoroughly dry the bore with clean cotton-flannel patches. Look through the bore to see if it is perfectly clean and free from metal fouling. If it is perfect, give it a thorough swabbing and coat with No. 3 gun oil. This will protect as well as clean. If you wish to store it for a long time, use the gun grease.

If, however, some fouling still remains in the bore, run a clean bronze bristle brush through several times, being careful that the brush and rod are free from oil or grease, and apply fresh solution in

the manner described above. Usually one application is sufficient, but in bad cases, two or even three applications are necessary.

As long as the ammonia retains its strength and the steel remains wet, it has no action on the steel. If, however, it is allowed to evaporate, the steel will rust very quickly; or if the solution is permitted to stand for a long time exposed to the air, the carbonate adds to the strength of the ammonia which will evaporate, and the remaining solution will rust steel very quickly. Therefore, take precautions to keep the bottle tightly corked, do not spill any of the liquid over the rifle or in the mechanism, and place a rubber tube over the muzzle so none will evaporate on the steel at the end of the barrel. The solution will remove any finish on the stock if spilled while using it, so it is well to wrap a piece of cloth around the forearm while doing this. Never pour the solution into a barrel that is still warm after firing, for such an application may completely ruin the barrel in a few seconds; always allow the barrel to cool first.

A well-made barrel should never pick up any metal from the bullet jackets. Usually this condition is caused by small grooves left by the reamers and rifling cutter, so minute that the eye is unable to detect them. If you have such a barrel and the metal fouling must be removed often, it is convenient to have a small measuring glass graduated so that you will know just the amount to use each time to fill the bore completely, thus obviating the danger of spilling by overflowing. It also makes pouring easier and quicker. In the absence of a mortar and pestle, the persulfate and carbonate may be powdered by placing in a clean cloth and pounding with a hammer.

The presence of oil or grease will saponify the ammonia solution and prevent its dissolving the metal fouling. When used exactly as described, this standard metal-fouling solution is perfectly safe and very effective.

Sulfur Casts — Sulfur casts are often necessary as a means of measuring accurately the chamber of a rifle or the chamber and cone of a shotgun. Originally pure sulfur was used, but we discovered at the Arsenal that this shrunk between .001 and .002 inch, making it unsuitable for this purpose. After experimenting with various substances in an effort to find a cast that would not shrink materially, the following formula was compounded:

4 oz. sulfur
10 gr. powdered lampblack
1 tsp. gum camphor dissolved in alcohol

Heat the ingredients very slowly in a small ladle over a Bunsen burner, stirring constantly. When

the mixture arrives at a thin pouring consistency, it is ready to pour.

First prepare the chamber by a thorough cleaning and then by giving it a film of very light oil. This can best be done by slightly moistening a piece of cloth on the end of a stick or rod. A cork the size of the bore is selected and a piece of wire about $\frac{1}{16}$ -inch diameter—a little longer than the chamber—is inserted into the center. A ladies' hat pin is very convenient, or any wire of the same diameter. The wire is used as a reinforcement for the cast. Press the wire and cork into the bore about one-half inch ahead of the chamber, so it is possible to show a part of the rifling, or, on a shotgun, the cone.

With the rifle or shotgun barrels clamped between felt jaws in the vise, muzzle downward, pour the mixture into the chamber quickly and allow it to cool before removing the cast. To remove the cast, insert a cleaning rod into the muzzle and push lightly against the cork, and as it comes out, hold the cast by the end of the wire, which acts as a handle. You may now measure the cast, and you will find that such a mixture will give a fine and glossy appearance that can be measured at every point. However, it should be handled very carefully as it is extremely brittle. It is imperative that the mixture be heated very slowly, for otherwise it will become too thick to pour. The quantity given is more than required for one cast, but this can be reheated for others as needed.

Patterns — The gunsmith's work often demands the use of various patterns, such as those for aluminum and brass butt plates, adjustable and Schützen heel plates, pistol-grip caps, various accessories for the target shooter, etc. For this reason the student should be thoroughly familiar with this branch of study, for he can then take care of his individual requirements, and save much time by eliminating the necessity of going to a pattern shop where they usually demand a detailed drawing of each part. After your pattern is finished, give it to the foundry and they will make castings of it at a small expense.

Woods commonly used for patterns are white pine, mahogany, cherry, maple, birch, whitewood, and fir. For most of the larger patterns, white pine is considered the best, not only because it is easily worked, but because it readily takes glue and varnish, and is fairly durable for most gun parts. For medium and small-size patterns, especially when they are to be used often, a hard wood is preferable. Mahogany is often used for patterns of this class; cherry can be used, and so can scrap walnut. As mahogany has a close grain, it is not as susceptible

to atmospheric changes as a wood of coarser grain. If you are using cherry, never select green timber; maple and birch are preferable, especially for turned parts, for these woods take a good finish. It is very important that the wood selected be well seasoned; that is, it should be kiln-dried or kept one or two years before using, the time depending upon the size of the wood.

Patterns intended for repeated use are varnished as a protection against moisture, especially when in the damp moulding sand. (See Shellac Varnish.) The varnish used should dry quickly and have a smooth surface that draws readily from the sand. At least three coats should be applied to a pattern, the surfaces being rubbed down with fine sandpaper after applying the preliminary coats in order to obtain a smooth surface.

Glue for Patterns — There are many qualities of glue, both in the liquid, sheet, and pulverized form. (See Glue.) Whenever practicable, glued joints should be reinforced by nails or screws. A joint to be glued should be accurately fitted, because glue does not get a grip unless the parts are in close contact. If the end grain must be glued, first apply a sizing coat to fill the openings among the fibers. After the sizing coat is dry, apply the second coat to the surface and unite. If the preliminary coat is not applied, the open-end grain is apt to absorb the glue so rapidly as to weaken the joint. (This is also true in stock work.) The hot glue should be thin enough to spread easily. However, it can be thicker for pine than for the woods of a closer grain such as mahogany or walnut, because, aside from the quality of the glue, the holding or binding property depends upon the extent to which the glue enters the pores of the wood. All glued joints should be firmly pressed together with clamps immediately after the application. They should be given plenty of time in which to harden; between 20 and 24 hours in a dry place should be sufficient.

Shrinkage — The shrinkage allowance ordinarily made on patterns to compensate for the contraction of castings in cooling are as follows:

Cast-iron.....	$\frac{3}{32}$ to $\frac{1}{8}$ inch per foot
Common brass.....	$\frac{3}{16}$ inch per foot
Yellow brass.....	$\frac{7}{32}$ " " "
Bronze	$\frac{5}{32}$ " " "
Aluminum	$\frac{7}{32}$ " " "
Steel casting.....	$\frac{3}{16}$ " " "

The amount of shrinkage depends to some extent upon the shape and size of the casting. A plain casting that is long in proportion to its width will contract differently from one that is more compact, even tho both castings are of the same material. The pattern maker's shrinkage rule has graduations which are longer than the standard

measurements, to give the allowance directly. This device is hardly necessary for small parts in gun work.

Draft for Patterns — The draft or the amount of taper given to a pattern to facilitate withdrawing it from the mould depends somewhat upon the size and shape of the pattern. A general rule is to taper each side $\frac{1}{8}$ inch for each foot of surface to be drawn. The average amount for small patterns is about $\frac{1}{16}$ inch per foot, altho in some cases, as on pistol-grip caps or thin butt plates, it can be less. As a rule, however, there should be $\frac{1}{32}$ inch draft. The draft shapes away from the pattern's "face," which is usually uppermost in the mould when the pattern is drawn. Some patterns do not require draft because none of the surfaces are at right angles to the face, and very small patterns are made without draft.

Allowance for Finish — It is seldom that it is necessary to allow much for shrinkage on gun parts for a finishing job, as most of the pieces are polished and buffed. The amount added, therefore, to a pattern to allow for machining the casting varies greatly, depending upon the method of machining, the size of the casting, and the importance of having a clean surface free from flaws or defective spots. If castings are to be finished from the rough upon a disc grinder or polisher, very little allowance is sufficient; in fact the moulder can warp a pattern with allowance enough to allow for the finish.

Glue — The most commonly used glues in the shop are animal, casein, and cold liquid glues; each possesses properties which make it invaluable for certain purposes. Animal glue possesses strength, casein glue is the most water-resisting, and cold liquid glue is always prepared for immediate use.

Glue can be successfully heated only by means of a water-jacketed pot. The action of dry heat or direct steam is never recommended, for such methods usually result in overheating the glue. A good glue pot may be purchased very reasonably; it has a jacket, is electrically heated, and is made on the same principle as a fireless cooker. An automatic switch controls the amount of current, so that the proper temperature is maintained at all times.

If you cannot procure a glue pot of this kind, you can purchase an ordinary enamel double boiler at the hardware store, or place any smaller vessel in a larger pan of water. Vessels made of copper, aluminum, or with a porcelain lining are the most satisfactory for the use of animal glue, as they resist its acid action. For the best results, the inner pot should be covered while the glue is being

heated, to prevent the evaporation of the water and to keep the glue clean.

Glue comes in either the flake or powdered form. The only advantage of ground glue is that it need not be soaked so long. The amount of glue to be prepared depends upon the amount of gluing to be done. I would advise mixing only the quantity needed, since reheating reduces the strength, and the evaporation of water makes the solution too thick. Five ounces of dry glue mixed with $2\frac{1}{2}$ parts of water by weight make a pint of liquid, and this is sufficient for covering 8 to 10 square feet of surface. Larger or smaller quantities of dry glue will give proportional amounts of liquid.

The proper way to measure dry glue is to weigh it. No other method for the proportion of glue and water is as good or as accurate as weighing. Mixing glue according to dry measures, such as scoops, quart measures, buckets, etc., is not dependable, since flake glues may vary 100 per cent in bulk weight and ground glue 25 per cent.

Always soak glue in clean cold water before heating. Soaking in cold water gets the glue into proper condition to dissolve readily when heated. Soaking in warm water will not give satisfactory results. Soft water should be used, since the chemicals of hard water may injure the glue. The proportional amount of water necessary for soaking animal glue is determined by the grade of glue and the manufacturer, and weigh it for accurate results. $1\frac{1}{4}$ to $2\frac{1}{2}$ parts of water by weight to one part glue. Use the amount of water recommended by the work for which it is to be used—never vary.

It is advisable to add the glue to the water in small amounts and stir thoroughly until all is uniformly mixed. This is especially important when mixing ground glue. It keeps the glue from collecting in balls and thoroughly mixes it with the water. Use only clean containers for soaking the glue. The time for soaking glue depends on the form. Ground glue will dissolve in from thirty minutes to four hours, according to the fineness of the powder. It is necessary to soak flake glues from one to twelve hours according to the thickness of the chips.

In melting the glue, temperatures higher than 150 degrees Fahrenheit will destroy the strength of the glue. By all means, do not allow glue to boil. The electric glue pot will keep the glue at the right temperature, but if only a double boiler is available, test the temperature with a thermometer. A minimum of 120 degrees Fahrenheit for glue is also essential. The binding strength of glue depends upon its penetration of the wood. Glue below 120 degrees Fahrenheit will not penetrate, since the body of the solution is too heavy for per-

fect fluidity. Therefore, underheating glue is to be avoided as much as overheating.

In applying glue, be careful not to use too thick a solution. Glue must be thin to penetrate, and penetration is absolutely necessary for a successful joining. Fresh glue properly proportioned by weight and heated to the right temperature will have the right consistency. It will be well for the beginner to examine such glue carefully in order to see that it is all right in this respect. The continual heating of glue tends to make the solution thicker. It should always run from the brush in a thin stream and spread with ease. The thinning of melted glue with water impairs its strength, but the strength of a joint made with glue of the proper consistency is greater than one made with a solution that is too thick.

For stock work it will be best to use raw linseed oil instead of water. It requires longer to set, but is as perfect a waterproof glue as can be made. Instead of soaking the glue in water as recommended, have a vessel set aside containing linseed oil and glue. This can be used as the supply becomes low in the cooker.

Gun Maker's Glue—Dissolve four ounces of good animal-hide glue in sixteen ounces of strong acetic acid, by exposure to a gentle heat. This is not exactly a liquid glue preparation—it is only semi-liquid. It may be kept for any length of time desired, and when needed for use, a slight warming is all the preparation necessary. The student will find this very handy for his work and also very convenient in case he should have occasion to use glue that does not require a strong joint in the work. This preparation is one of the best, and thus prepared you are assured that the ingredients are of proper material.

Shellac Varnish — This is used for a number of purposes, not only on stock work, but in the finishing of patterns, tool blocks, the tops of benches, etc. To make the varnish, place the shellac in a clean receptacle, covering it with pure grain alcohol. When it is to be used for stocks or patterns, bench tops, blanks, etc., wood alcohol may be used. When preparing this, enough alcohol should be used to cover the shellac completely. After it is fully dissolved and is still too thick, more alcohol can be added to thin it down to the required consistency. Too much warmth will tend to evaporate the alcohol, and for this reason it should be well-nigh sealed from the air. It may take one or two days for the alcohol thoroughly to dissolve the shellac; this depends upon the temperature in which it is placed. When the gum is dissolved, thin with alcohol to the proper consistency, and for easy ap-

plication use a brush. If the mixture should be dirty, filter it through filtering paper to remove all foreign substances.

Colored shellac is often desirable. The color of the varnish is commonly changed and various substances may be added. Lampblack is used for a black shellac; a red varnish can be made by adding Chinese vermilion, etc. (See "Where Colors Come From.") All coloring powders should be well pulverized before adding them to the varnish.

Steaming Woods for Bending — An erroneous belief exists among many men that a rifle or shotgun stock can be made as pliable as a piece of putty, to secure any drop, bend, or cast-off, by just steaming it in a steam box. My advice is never to try it, even as an experiment, unless you want a ruined stock. Take a shotgun as an example; a little common sense will tell you that with all the cut-outs for the action, it would be an impossibility to perform this operation; for when the steam begins to penetrate, the walnut will warp in all directions and the cut-outs will expand so much that the action will never go back in place. Furthermore, the knots, or burls, or even crotch wood that the stock contains would all open up to such an extent that you would be able to insert a knife blade in the wood to the depth of half an inch or more. Such openings would run from one to three inches, and in some cases longer, irreparably disfiguring the stock.

The only satisfactory way to change the bend in a stock, in either rifle or shotgun, is to apply hot raw linseed oil to the grip, which will make it possible to bend the wood slightly in any direction, at times as much as one-half inch. After wrapping a number of pieces of cloth around the grip well back from the action, pour hot linseed oil over these and allow to stand between a half and one hour. Then grip the butt end of the stock and twist or bend to any shape you may desire. The best time to do this is late in the afternoon before going home. There are two reasons for this: heating the oil over the gas flame, particularly when it comes to the boiling point, produces an odor; and after the bending operation it is much better to let the stock stand over night. Remove the oil-soaked cloths the next morning, completely disassemble the action, and clean out any linseed oil that has run into the mechanism.

I find that men who live near a body of water and are familiar with the handling of woods use this method for bending and twisting timbers in boat building. Perhaps the following information regarding a steam box will not be amiss.

Long or short strips, and even planks, can be

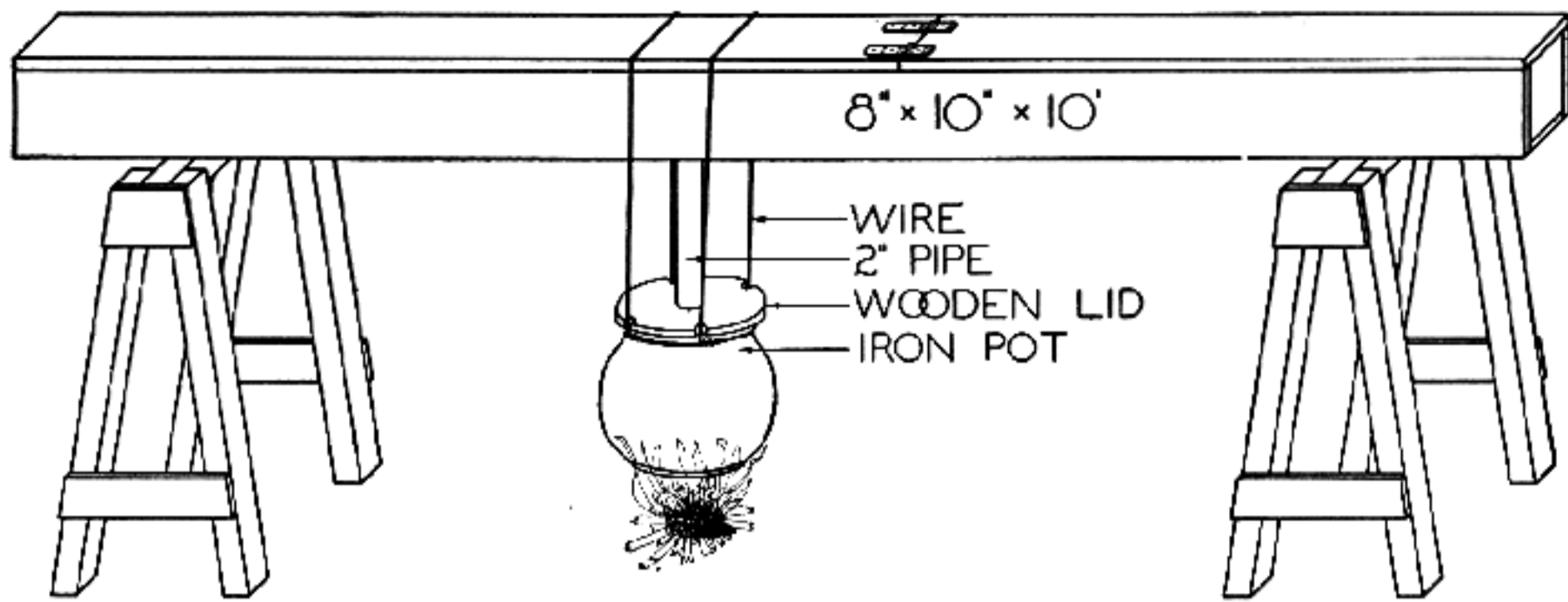

Fig. 146
Home-made steam box

made pliable by steaming them from one-half to one hour in a cheaply constructed steam box such as Figure 146 illustrates. The size of the box will naturally depend on the work you intend to do. Boxes all the way to 35 feet in length by 3 feet square have been made for bending planks in boat building. For ordinary work, however, a box 10 to 12 inches square by 8 to 12 feet in length will be ample for the student who is interested in small boats or other work of a nature that includes the bending of wood.

The box is made of inch boards, nailed together with tenpenny nails, about 6 to 8 inches apart, with one end closed permanently and the other end either furnished with a hinged lid and two side catches, or left open entirely. When the latter scheme is resorted to, an old piece of carpet, burlap, or lid can be used to close up the end. Even when the hinged lid is used, it is well to use a piece of burlap.

An ample sized pot with a wooden lid made to fit the opening tightly is also needed. A hole is cut in the center of the bottom of the steam box with a compass saw, large enough to take a piece of pipe $1\frac{1}{2}$ to 2 inches in diameter. The pipe must fit very tightly and be of sufficient length to prevent the box from coming too near the fire—say four feet from the ground.

The kettle is suspended from the middle of the box by means of a strong wire or chain over the fire. The wooden lid is furnished with an opening for a funnel to supply the kettle with water, but the opening is closed with a tight-fitting cork when the funnel is not used. The box is generally placed upon a couple of trestles or horses outside the shop, but within convenient reach. Charcoal or any material that makes a good fire may be used under the kettle to generate the steam. Altho this information may seem a bit superfluous in a book of this nature, the young man who is interested in all classes of sports and aspires to carry out different

ideas will find this particularly remunerative, but *do not try it in gun stocks.*

Loose Wood Screws — Very often wood screws pull out, especially those used in the end grain of the wood. Whenever this happens, I usually bore out the hole to a much larger size, make a wooden plug of a harder variety, glue it in place, allow it to stand for 24 hours, and then refit the screw. However, this is sometimes impractical, especially when one is in a hurry. Then the most convenient method of making a loose screw hold is to use a piece of fine lead wire. Wind this around the threads of the screw, thus increasing the diameter of the threaded part, and screw it back in place. Such a simple operation often saves the plugging of the hole.

Testing Iron and Steel — A very satisfactory chart was worked out at Purdue University to test steel by the spark method on an ordinary emery wheel. But in using this method when in doubt about a certain piece of steel that had not been marked in the shop, I have often been fooled in the alloy steels, by the sparks. Cold-drawn and especially machinery steel will produce a dull spark, and if the carbon contents are rather high in the cold-drawn steel you can always detect this, and consequently discover what you have. Carbon tool steel can never be mistaken, because it gives off a dull continuous red glow without the presence of the bursting sparks which emanate from other steels. Nor can high-speed steel be mistaken, for it has only a dull short length of spark similar to the alloy steels, only one-half inch or more in length from the test piece, whereas the alloy steels lengthen out the dull sparks at times more than three inches. The wise student will secure five samples of the steels I have named and have them marked. Touch each one to the face of an emery wheel and note the sparks. When once seen, they

will never be forgotten. If, however, you are in doubt, take small pieces and harden them by the different methods which have been described in previous chapters.

Home-made Drill Press — Three machine tools are almost indispensable in the tool equipment: the lathe, the drill press, and the grinder. Next to the lathe in importance comes the drill press, and while the latter does not cost nearly as much as the former, its price is sufficient to make a large dent in the student's purse. However, it is possible to construct a press which will answer the purpose for many simple jobs. This is the method I employed when I found the need of a small drill press. You will be surprised to know what a number of drilling jobs a press made from a cheap breast drill will be able to perform.

The frame and table were made from wood and built against the wall in the cellar. First, I constructed the table from a piece of maple, 1 x 15 x 18 inches, and fastened to a 2 x 8 inch with two braces on each side. On the back of this I bored a 1-inch hole to allow the wire to go through for operating the head. A piece 1½ x 6 x 8 inches grooved on each side was made for the head to slide on. Then a head was made with gibs so that it was possible to slide it up and down. Next, suitable brackets were made from 5/16 x 3/4 inch cold drawn steel to be clamped to the breast drill at the bottom and top, and at the same time fastened to the movable head which stood away just 12 inches from the wall. Two hooks were screwed in the head; one at the top and one at the bottom. The top hook has a very heavy compression door spring connected to the head and then fastened to the ceiling, a device which always held the head to the top. On the bottom hook a wire was attached, and fastened to a hinged board which acted as a foot feed or treadle, so that when using the drill it was possible to apply the required pressure while revolving it by hand. The face plate, made as large as 18 inches out from the head, allows for the largest work you may have. All parts should be square and level. The drill-press breast drill and all can be made for about three dollars, and the results will more than pay for it. Figure 147 illustrates one of these.

Where Colors Come From — The cochineal insects furnish a great number of the very fine colors; among them are the gorgeous carmine, crimson, scarlet, and purple lac.

The cuttlefish provides sepia, an inky fluid which the fish discharges when attacked, in order to render the water opaque.

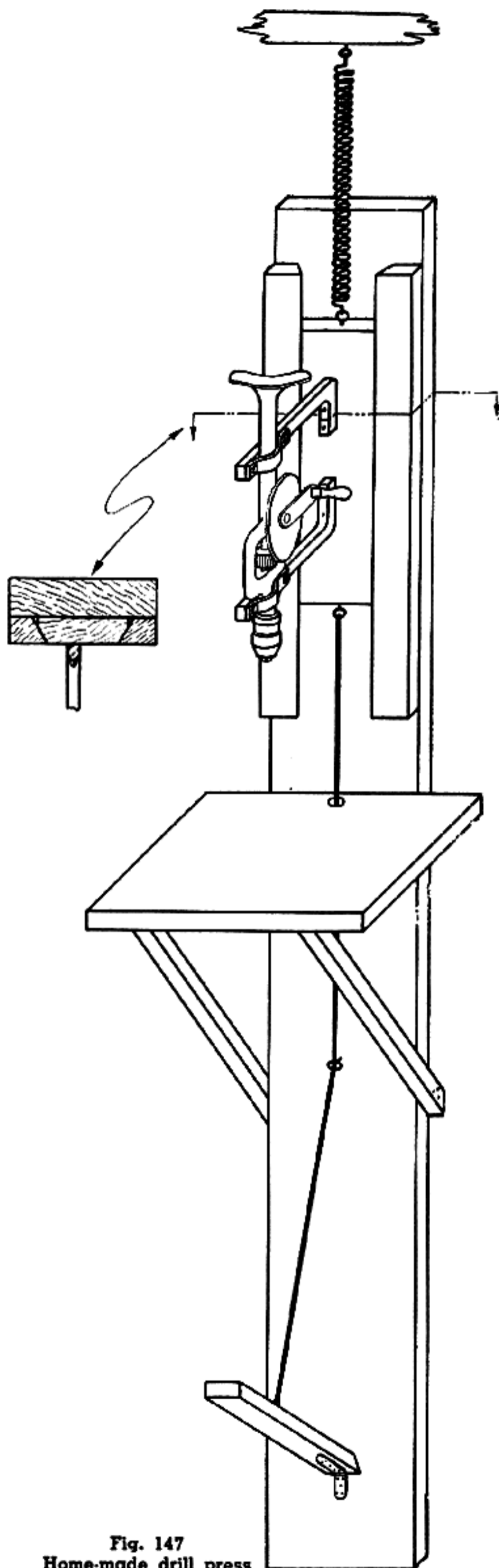

Fig. 147
Home-made drill press

India yellow comes from the camel.

Ivory chips produce the ivory and bone black.

The exquisite Prussian blue is made by fusing horses' hoofs and other refuse animal matter with impure potassium carbonate. (This color was discovered accidentally.)

Various lakes are derived from roots, barks, and gums.

Blue-black comes from the charcoal of the vine stalk.

Lampblack is soot from certain resinous substances.

Turkey red is made from a plant which grows in Hindustan.

The yellow sap of a tree in Siam produces gamboge. (The natives catch the sap in coconut shells.)

Raw sienna is the natural earth from the neighborhood of Siena, Italy.

Raw umber is also an earth found in Umbria, Italy, and burned.

India ink is made from burned camphor. (The Chinese are the only manufacturers of this ink and they will not reveal its secret.)

Mastic is made from the gum of the mastic tree, which grows in the Grecian Archipelago.

Bistre is the soot of wood ashes.

Useful Information — To find the circumference of a circle multiply the diameter by 3.1416.

To find the diameter of a circle multiply the circumference by .31831.

To find the area of a circle multiply the square

of the diameter by .7854.

The area of a rectangle is the length multiplied by the breadth.

Doubling the diameter of a circle increases its area four times.

To find the area of a triangle multiply the base by $\frac{1}{2}$ the perpendicular height.

To find the surface of a ball multiply the square of the diameter by 3.1416.

To find the side of an inscribed square multiply the diameter by 0.7071, or multiply the circumference by 0.2251, or divide the circumference by 4.428.

To find the side of a square that shall be equal to a given circle, multiply the diameter by .8862.

Square: a side multiplied by 1.4142 equals the diameter of its circumscribing circle.

A side multiplied by 4.443 equals the circumference of its circumscribing circle.

A side multiplied by 1.128 equals the diameter of an equal circle.

A side multiplied by 3.547 equals the circumference of an equal circle.

Square inches multiplied by 1.273 equals the circle inches of an equal circle.

To find the cubic inches in a ball multiply the cube of diameter by .5236.

To find the cubic contents of a cone, multiply the area of the base by $\frac{1}{3}$ the altitude.

Doubling the diameter of a pipe increases its capacity four times.

A gallon of water (U. S. standard) weighs $8\frac{1}{8}$ lbs. and contains 231 cubic inches.

CHAPTER XXVI

Soldering, Brazing, and Welding

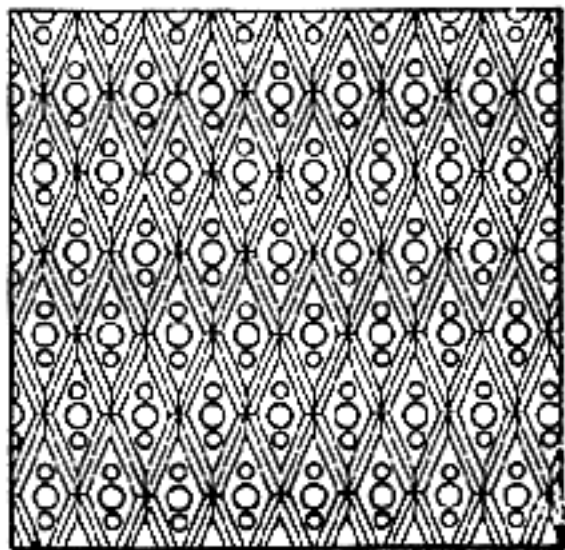

Soldering, Brazing, and Welding

IF ONE has any knowledge of joining metals together, he will find soldering, brazing, and welding very simple operations. Soldering is the method of joining metals by means of lead and tin mixed in a given proportion. Brazing involves a higher heat and the use of different materials. Welding is the most difficult of the three, requiring at least three weeks' practise before any degree of success is attained; soldering and brazing can be mastered in one week. This is due to the ease with which softer metals adhere to steel, iron, brass, copper, etc., when the proper fluxes are used.

Soldering—Solders for joining metallic surfaces or edges are almost invariably composed of an alloy of two or more metals. The solder used must have a lower melting point than the metals to be joined by it, but the fusing point should approach as nearly as possible that of the metals to be joined, so that a more tenacious joint is effected. Solders may be divided into two general classes, hard and soft; the former fuses at a red heat, the latter at a comparatively low temperature. These solders are also subdivided into a variety of classes such as brass, silver, gold, copper, tin, plumber's solder and others—the name in most cases designating the application.

Almost everyone thinks he can solder, yet if we examine the work carefully we find that only about ten per cent of the work is done as it should be. Tho soldering is referred to as sweating, there is a remarkable difference in strength between a well-fitted and sweated union of the metals and one ordinarily soldered. An important point frequently overlooked is properly cleaning the surfaces to be joined, an operation too often left for the flux to correct. The after effects resulting from improper cleaning before soldering are far worse than the good effects of the soldering. This is particularly noticeable in gun work. Another neglected point is the selection of the flux to be used, altho nearly all metals can be joined by the use of the same flux. For strength, fit the parts accurately. The more accurate the fitting, the stronger the union. Use a solder with as high a melting point as possible. Apply the proper heat. The nearer the temperature of the work to be joined is brought

to the fusing point of the solder, the better will be the union, since the solder will then flow more readily.

Fluxes—The action and use of a flux in soldering is to remove and prevent the formation of an oxid during the operation of soldering, and to allow the solder to flow readily and to unite more firmly with the surfaces to be joined. There are on the market a number of fluxes or soldering salts that are giving good satisfaction. A salt that is very popular with gunmakers is the No-ko-rode Soldering Salts. All that is necessary is to make a saturated solution of the salts in water, and apply with a soldering brush.

For sheet tin, on the best work, rosin or colophony is used, but, owing to the ease of applying and rapidity of work, zinc chlorid or acid is more generally used. Beeswax can also be used and almost any of the pastes, fats or liquids prepared for that purpose.

For lead, a flux of oil and rosin in equal parts of the liquids works very well. Tallow is also a good flux. Rosin and colophony are much used, and zinc chlorid will keep the surfaces in good condition. Lead burning is a different operation from soldering, and at the present time almost a lost art. The surfaces must be bright and free from oxid. Solder is not used as a flux but a piece of lead with rosin and oil.

The following is a list of fluxes to be used:

Hydrochloric or Muriatic Acid—The ordinary commercial acid is much used in full strength or slightly diluted to solder zinc, particularly where the zinc is old or covered with an oxid.

Rosin or Colophony, Powdered—Commonly used for copper, tin and lead; very generally used by canneries and packing houses on account of its non-poisonous qualities. It is also used mixed with common olive oil.

Turpentine—This can also be used as a flux.

Tallow—Is also used for lead pipe but is more frequently mixed with rosin.

Beeswax—Is good and can be used often in place of other fluxes.

Palm or Cocoa Oil—Will work well, but is most generally used in the manufacture of tin plate. The

common green olive oil works very well with the more fusible solders as expedients. We can use a piece of common stearin candle, common brown rosin, or soap, or cheap furniture varnish largely composed of rosin. Paraffin, vaseline, and stearin are recommended for use with some of the alloys for soldering aluminum.

Chlorid of zinc acid, or soldering liquid—Most commonly used of all fluxes; usually prepared simply by dissolving as much scrap zinc in the ordinary commercial hydrochloric acid as it will take up. But if it is diluted with an equal quantity of water and a small quantity of sal ammoniac is added it works much better and is less likely to rust the articles soldered. If they are of iron or steel, about two ounces to the pint of solution is about the proper quantity of powdered sal ammoniac to add. In preparing this solution, a glass or porcelain vessel should be used; owing to the corrosive fumes, it should be done in a well ventilated place. Use a vessel of ample capacity, for there is a considerable foaming or boiling of the mixture.

Soldering Liquid I—Non-corrosive. Prepared by dissolving the zinc in the acid as above and adding one-fourth of the quantity of aqua ammonia to neutralize the acid; the diluting is done with an equal amount of water.

Soldering Liquid II—Neither corrosive nor poisonous. Dissolve $1\frac{1}{2}$ parts glycerin in 12 parts water and add $1\frac{1}{2}$ parts lactic acid.

Soldering Paste—When a solution of chlorid is mixed with starch paste, a syrup liquid is formed which makes a flux for soldering.

A very good acid mixture for cleaning work to be soldered is equal parts nitric and sulfuric acid and water. *Never pour the water into the acid!*

A very good job of soldering can be done on work that will permit it, by carefully fitting the parts, laying a piece of tin foil covered on both sides with a flux between the parts to be joined, clamping together, and heating until the foil is melted. This is very good for joining broken parts of brass and bronze work. If they fit well together, they can frequently be joined in this manner so that the joint is very strong and almost imperceptible.

A solution of copper for copper-plating steel or cast-iron before soldering will work by simply immersing the work in it. This is also useful for coppering the flutes of reamers before stoning, also on the surface of dies, templets, and tools for laying out. Scribe the lines so they can readily take—copper sulfate $3\frac{1}{2}$ ounces, sulfuric acid $3\frac{1}{2}$ ounces, water 1 gallon. Dissolve the copper sulfate in the water and add the acid.

The best solder for gun work such as soldering ramps, rear-sight bases, sling-swivel bases, etc., is 75 per cent lead and 25 per cent tin which has a melting point of 482 degrees Fahrenheit. We cannot apply a low-melting solder to gun work because of the heat the rifle or shotgun may be subject to, as in Africa or any other parts of the world where the heat becomes so terrific that parts may be melted off firearms, making them useless.

The soldering copper for the beginner's use should be about $1\frac{1}{2}$ pounds in weight. The length should be $2\frac{1}{2}$ to 3 inches of an octagon form with a square pyramidal point. It is fixed to an iron rod about 8 inches long, on the end of which is a wooden file handle. When heating the copper for use, the best way to ascertain the proper heat is to hold it near the face; if a bright warm glow is felt, it is hot enough. If heated too much, the tinning will be burned off and it will not work satisfactorily. To replace the tinning, heat it just warm enough to melt the solder and file the surface bright and smooth. Then dip in No-ko-rode Soldering Salts, and reheat and redip into the solution very quickly and apply or rub the solder on the bright surface until it is well coated all over. Wipe off with a tag; it is now ready to use for any soldering. With an electric soldering iron there is not a great amount of danger in burning off the tinning, except when forgotten and left on too long. When necessary to retin, follow out the instructions given for the copper soldering iron.

Soft Solders—Soft solders consist chiefly of lead and tin, altho other metals are occasionally added to lower the melting point. Lead-tin alloys melt at a lower temperature, with the increase in the percentage of tin up to a certain point, but when the tin exceeds 67 per cent, the melting point rises gradually to the melting point of lead, as shown in this table.

		MELTING TEMPERATURE (Degrees Fahrenheit)
Tin	Lead	
0	100	618
10	90	577
20	80	532
30	70	491
40	60	446
50	50	401
60	40	368
66	34	356
70	30	365
80	20	388
90	10	419
100	0	466

Soft solders are termed "common," "medium," and "fine," according to the tin contents. Those containing the most lead are the cheapest and have the highest melting temperatures. Fine solder is largely used for soldering britannia metal, brass,

and tin-plate articles. It is also used for soldering cast-iron, steel, copper, and many alloys. The soft solder called "common" is used by plumbers for ordinary work; this solder contains two parts lead to one part tin. The best soft solders are made from pure lead and pure tin and used altogether by the gunsmith, altho 30 parts tin and 76 parts lead is preferable on most barrel work. Solder which comes in the wire is the best to use, for the reason that it is possible to get it into places where a large bar of solder could not enter.

Hard Soldering and Brazing — Hard solder is used for joining such metals as copper, silver, and gold, and alloys such as brass, German silver, gun parts, etc., which require a strong joint and often a solder the color of which is near that of the metal to be joined. The hard soldering of copper, iron, brass, etc., is generally known as brazing and the solder as spelter. The operations of hard soldering and brazing are identical, and the two terms are often used interchangeably. There is a distinction, however. Brazing is generally understood to mean the joining of metals by a film of brass, whereas hard soldering (which is the term used by jewelers) ordinarily means that "silver solder" is used as the uniting medium.

For hard soldering or brazing a red heat is necessary, and borax is used as a flux to protect the metal from oxidization and to dissolve the oxids formed. Heating cannot be done with a soldering iron, but should be effected by a blow pipe, blow torch, gas forge, or a coke or charcoal fire. As a greater degree of heat is required to melt spelter than soft solder, brazed work will withstand more heat without breaking or weakening than that soldered. The chief advantage of a brazed joint, however, lies in its superior strength. Before work is assembled for brazing, it should be carefully cleaned and the parts fastened together in the position they are to occupy and joined. Usually the pieces are secured by clamps or fixtures, but sometimes wire is used for holding the parts together. Whenever practicable, they should be secured in such a way that the work can be turned over during the process of brazing without disturbing the relation of the parts, thus affording a better chance to apply the flux and spelter.

Sweating — When parts are soldered together by heating them sufficiently to melt the solder instead of using a soldering iron, the operation is often known as sweating. Ramps and sight bases are usually sweated together prior to machining in order to secure them to the barrel in perfect alinement. The finished surfaces forming the joint

between the bases and the barrel are first tinned or covered with solder. This is done by heating the barrel and bases enough to melt the solder; apply a flux (such as No-ko-rode Soldering Salts) and finally the solder. After tinning, the bases are held to the barrel by clamps and again heated until a perfect union is had. Too long exposure to the heat after the solder is melted would spoil the joints.

The equipment used for this operation may be an acetylene torch, blow torch, or Bunsen burner, the latter being the best. Of course, any kind of clean fire can be used, providing the flames do not affect other parts of the mechanism in the weapon. It will be well for the beginner to take two pieces of iron or steel to acquire this experience. Two cartridge cases will serve the purpose; file the base of each and tin them with solder; by holding the two together with pliers over the flames a union is made. If it is perfect, the cases will break before the joint.

Fluxes for Soldering — As two pieces to be soldered must be thoroughly alloyed with the materials used as a solder, the temperature must be raised and maintained at such a point that interpenetration can take place completely. It is necessary that the surfaces to be joined be perfectly clean, and means must be provided to prevent oxidization during soldering. Oxids tend to prevent interfusion. This is accomplished by using a coating of some substance that melts at the fusing temperature of the solder, air being excluded. The coating should have a solvent action on the oxid, thus keeping the metal clean and enabling the metal and solder to unite thoroughly. The fluxes generally used are rosin, sal ammoniac, zinc chlorid and borax. The flux is added first and the solder melted by means of a flame or soldering iron, the latter first having been smoothed with fine emery cloth or a file and then properly tinned. Rosin and chlorid of zinc are fluxes commonly used for soft-soldering tin (tinned iron), brass, etc. Rosin is used alone when soldering ribs to shotgun barrels, so that no corrosion will take place between the ribs and barrels. For hard soldering or brazing, use burnt or calcined borax, or boracic acid in powdered form. In all cases where zinc chlorid is used as a flux, the articles should be cleaned after soldering to prevent subsequent corrosion of the metal. This is the basis of almost all soldering salts on the market.

Alloys for Brazing Solders — The alloys or "spelters" used for brazing are composed of copper and zinc alloys. The melting point of these alloys

depends upon the percentage of zinc. As the proportion of zinc increases, the melting point is lowered as shown by the table. The fusing point of spelter should be as close as possible to that of the article to be brazed, as a more tenacious joint is thereby secured. An easily fusible spelter may be made of two parts zinc to one part copper, but the joint will be weaker than when an alloy more difficult to fuse is employed. A spelter that is readily fused may be made of 44 per cent copper, 50 per cent zinc, and 6 per cent tin. Melting temperatures of copper-zinc alloy are:

PERCENTAGE		MELTING TEMPERATURE (Degrees Fahrenheit)
Copper	Zinc	
100	0	1980
96	4	1967
86	14	1890
80	20	1846
76	24	1796
72	28	1756
71	29	1746
63	37	1666
50	50	1616
35	65	1501
29	71	1467
24	76	1364
20	80	1301

This is a very good alloy when a solid joint is desired, as it will adhere firmly to steel or other metals, and under no circumstances will it come loose when used on ramps, swivel bases, and rear-sight bases; you will find that it fuses in a much lower heat.

Any alloy containing lead should be avoided, since lead does not transfuse with copper and thus decreases the strength of the joint. A hard solder for the richer alloys of copper and zinc may be produced from 53 parts copper and 47 parts zinc. Copper and iron have a much higher melting point than brass, thus allowing the use of a rich copper alloy. Tin is often added to the ingredients for gun work but should be used sparingly for other classes of work because it increases the brittleness of the solder. The addition of tin to the copper and zinc lightens the color of the joint, giving it a gray tint and is not so noticeable after bluing.

Silver Solder—This is a hard solder containing silver, copper, and zinc or brass. The composition of silver solder varies according to the nature of the work. A silver solder used very often by gunmakers contains 70 per cent silver and 30 per cent copper. Silver coins may be used for small work. Silver soldering is employed for uniting comparatively small parts requiring a strong joint. The heating is usually effected by a blow pipe, and borax or powdered boracic acid may be used as a flux. The flux should be applied before heating if possible.

A very good hard solder of low fusing point, used extensively by gunmakers, is composed of: 34.36 per cent copper; 49.24 per cent silver; and 16.40 per cent zinc. Borax is used for a flux. Solders for German silver are generally made of the same materials as those which compose the alloy to be soldered, but in such proportions that the melting point is lower. In some cases, silver solder is used for uniting German silver articles; German silver solder is also used for soldering articles of iron and steel because of its high melting point and tenacity. German silver solder is known under such names as Argentan, Arguzoid, etc. It is rendered moderately fusible by an addition of zinc to copper and nickel. If the solder is too brittle, it is an indication of too much zinc. This defect can be remedied by adding the requisite amount of copper and silver. For soldering alloys composed of from 16 to 22 per cent nickel, the following proportions may be used as a solder: copper, 47 per cent; nickel, 11 per cent; zinc, 42 per cent.

Brazing will find its proper place in the realm of gunsmithing. It is used extensively for repairs on all classes of arms, on tangs, guards, shotguns, broken parts of factory arms such as the Winchester, Remington, Savage, and Stevens, or on antiques.

Figure 148 shows a fixture which is used for brazing ramps, sight bases, swivel bases, etc. With such a muffle or hood, all parts of the barrel do not come in direct contact with the flames. It is especially useful when a blow torch or large gas flame is employed. The device insures a uniform heating at the point where the flame is needed, resulting in a clean smooth surface, when low-melting spelter or silver solders are used. When an acetylene torch is used for the purpose of brazing, such a fixture is not necessary. When attaching sight bases or swivel bases to barrels, the inside must be wiped perfectly clean and a coat of bone-black mixed with light paraffin oil applied to protect the bore from scale or oxidization. It is very bad practise to braze any parts to hardened receivers or actions of rifles or shotguns. Soft solder must be employed and the parts held by screws to protect the addition from recoil, for if soft solder is used alone a sudden shock will break it off. Brazing is especially adapted for joining barrel drills to oil tubes. In such work there are always special fixtures employed, as there are also in brazing or silver-soldering any parts to shotgun barrels. If a torch is not available, or even a gasoline blow torch, the fixture shown in Figure 148 may be turned over on its side in the forge, allowing the flames to come through the round opening. When

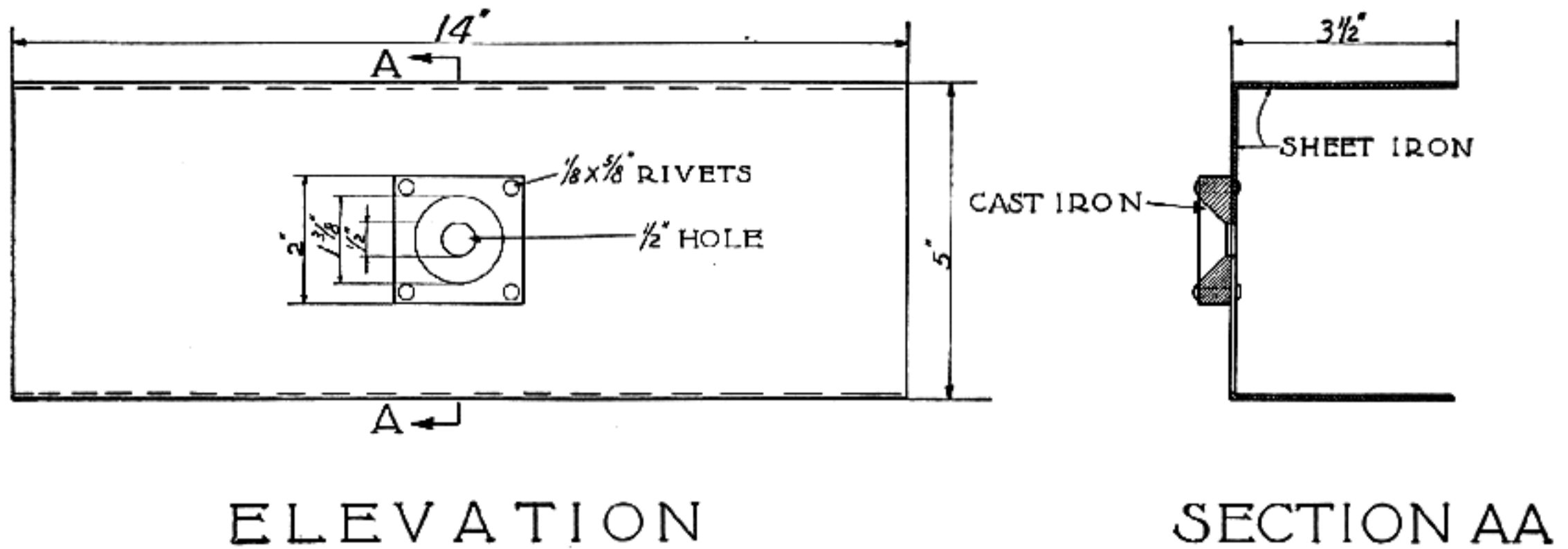

ELEVATION

SECTION AA

Fig. 148

Fixture for brazing ramps, sight bases, swivel bases, etc.

it is used over a forge fire, a coke or charcoal fire is preferable to soft coal. It may be necessary to enlarge the opening to the flame inlet until the required amount of heat is given to form the union.

Spelter or silver solder may be purchased from any of the large hardware houses. If they are unable to secure the correct alloy as given in the tables, it is an easy matter to make your own by melting the alloys in a small crucible and casting your own rods by forming a suitable mold from sheet-iron over a $\frac{3}{16}$ -inch piece of drill rod 12 inches long, and pouring the spelter into this. Rods between $\frac{3}{32}$ and $\frac{1}{8}$ inch are more desirable, but when casting $\frac{3}{16}$ -inch rods, form a temporary mold shaped in such a manner that the rods will come out successfully and will be the limit of the size.

Iron or steel surfaces must be thoroughly cleaned before brazing. The surfaces must be made bright either by filing, grinding, or using a sand blast. Brass or bronze parts can be cleaned by dipping them in a solution of one-third nitric acid and two-thirds sulfuric acid. This same solution can be used to remove the scale after brazing.

Brazing Cast-iron — There are so many cheap actions made from cast-iron that it will be well to say a few words about the methods used. First remove all dirt and grease from the pores of the metal by heating to a dull red. The surfaces should then be cleaned either with a sand blast or a wire brush. After cleaning, the parts must be fastened together in the position they are to occupy when brazed. The fastenings may be effected by the use of screws, wires, bolts, clamps, etc. If practicable, the parts should be held in such a way that they can be turned over during the process of brazing without disturbing the alinement, in order to facilitate the application of flux and spelter.

A good formula for cast-iron brazing is as follows:

Boracic acid	8 oz.
Chlorid of potash	2 oz.
Carbonate of iron	1½ oz.

This mixture should be kept dry as moisture or long exposure to the air renders it less effective. The preparation is mixed with grain spelter immediately before using. Heat the work to a bright yellow color and apply the flux and spelter with an iron rod flattened at the end. This method is for an open fire, but when an acetylene torch is used, the bar-rod spelter can be used. After brazing cast-iron, let it cool slowly, as sudden chilling may be injurious.

Autogenous Welding — The process of fusing and uniting metals by the application of intense heat without compression or the use of a flux is termed "autogenous welding." The temperature required is obtained by the combustion of a mixture of gases such as oxygen and acetylene or oxygen and hydrogen. One or both of these gases may be under pressure. The gases are mixed in the nozzle of the torch prior to combustion. Ordinarily the weld is formed by fusing in additional material between the surfaces of the joint. This material is in the form of a rod or a wire and may or may not be of the same composition as the material being welded. This is one of the most useful means of obtaining results; no other manner is possible for the gunmaker. An oxy-acetylene torch is, however, advantageous and one of the most economical additions to the general equipment. It is used for many off jobs such as sweating on ramps, sights, and swivel bases; for brazing, soldering, sweating, and bending bolt handles, etc.; also for the welding of broken parts such as hammers, actions, triggers, plates, and parts from factory arms.

The temperature of an oxy-acetylene torch is approximately 6300 degrees Fahrenheit, and the temperature of an oxy-hydrogen flame is 4000 degrees Fahrenheit. With the former, the number of British thermal units per cubic foot is about five times greater than is obtained with the latter.

Installing the Equipment—1. See that the following equipment is available:

- 1 oxygen cylinder
- 1 acetylene cylinder
- 1 oxygen regulator
- 1 acetylene regulator
- 1 length of $\frac{1}{4}$ -in. acetylene hose 10 ft. to 12 ft. long
- 1 length of $\frac{1}{4}$ -in. acetylene hose 4 ft. long
- 1 length of $\frac{3}{8}$ -in. air hose 10 ft. to 12 ft. long
- 1 acetylene cylinder valve wrench
- 1 air regulator
- 1 spark lighter
- 1 kit of tools

2. Place the oxygen cylinder to the left of the acetylene cylinder and either clamp them together or chain them separately to the wall or a post to prevent them from tipping over.

3. Remove caps from both cylinders. These caps are used to protect the cylinder valves during shipment and should be placed where they can be readily found when the cylinders are empty and are to be returned to the recharging station.

4. Slightly open both the oxygen cylinder valve and the acetylene cylinder valve, using the valve wrench in the latter case. Opening the valves in this manner assures that they will open easily and that any dirt or grit in the valve outlet will be blown out. The valves should be closed immediately after they have been slightly opened and a little gas allowed to escape. Remember that acetylene gas is highly inflammable and will ignite if it comes in contact with a spark or flame.

5. Attach the oxygen regulator to the outlet of the oxygen cylinder valve, using a wrench to insure that the connecting nut is tight.

6. Unscrew the adjusting screw of the oxygen regulator by turning it to the left until it turns easily—that is, until all pressure on the spring upon which it rests is closed. Slowly open the oxygen cylinder valve. The regulator is now closed. The full pressure within the cylinder—about 2000 lbs. per square inch—is now apparent upon the dial of the cylinder pressure gauge.

7. Turn the adjusting screw of the oxygen regulator to the right a few turns until a little pressure is placed upon the spring within the regulator, thus opening the valve and allowing a little oxygen to escape from the regulator outlet. This will blow out any dirt or grit which may have accumulated in the outlet nipple.

8. In a similar manner connect the acetylene

regulator to the outlet nipple of the acetylene cylinder valve, being sure that the connecting nut is tight, and releasing the adjusting screw of the acetylene regulator to the right until a little pressure is placed upon the spring and the valve begins to open, delivering a small quantity of acetylene through the outlet nipple. The adjusting screw should immediately be released to prevent the escape of acetylene into the room.

9. Attach the straight part of the "Y" of the gas mixer (a right-hand thread) to the oxygen regulator outlet, and the acetylene hose (having a left-hand thread) to the acetylene regulator outlet. These hose nuts cannot be interchanged because they are provided with right and left hand threads to prevent the wrong nut from being placed upon the regulators. Using the regulator adjusting screw, blow a little oxygen and acetylene through the mixer to remove any dirt or grit that may have collected. Do not waste the gases unnecessarily and remember that too much acetylene must not be allowed to escape into the room.

Oxy-Acetylene Torch—The arrangements of a standard torch for medium and heavy welding are two small pipes which have hose connections at one end. The opposite ends are attached to a head which holds the torch tip or nozzle. The pipe for acetylene opens with a cylinder which serves as a handle and is packed with a porous material that makes it impossible for the flame to pass this point; however, "flash back" is not likely to extend back of the tip. The tips are interchangeable, different sizes being required for various classes of work. The mixture of the oxygen and acetylene gases takes place within the tip. The acetylene is admitted under lower pressure than the oxygen—through inlets at right angles to the oxygen inlet to insure thorough mixing. Regulators on the storage tanks serve to control the working pressure of both gases.

Adjusting the Torch—Before lighting the torch, the regulator on the oxygen tank should be set to give the required pressure. For the average pressures used for welding different metals, thicknesses are given in tables furnished by the manufacturers. The acetylene is lighted first, the regulator being adjusted so that there is a fairly strong flame. The full pressure of the oxygen is then turned on, after which the acetylene pressure is varied by means of the regulator until the two cones which appear in the flame at first are merged into one small cone. After this cone is formed, no more oxygen should be added. It is also well to test the cone occasionally by increasing the acetylene pressure slightly, which will immediately cause an extension

of the point of the cone. When the cone is properly formed, it will be neutral so that it will neither oxidize (burn) nor carbonize the metal. An excess of oxygen will cause burning and oxidization; an excess of acetylene will carbonize the metal. The tip of the cone should just touch the metal being welded but not the point of the torch, as this might cause a "flash back." An excessive discharge of sparks indicates that too much oxygen is being used and the metal is being burned or oxidized, altho in welding thick metals there will be a considerable volume of sparks even tho the flame is neutral.

Size Tips to Use—The proper size of tip to use for welding depends upon the thickness of the work and the rate at which the heat is dissipated. Sometimes the rate of conduction and radiation is affected by the location of the parts to be welded. In general, heavy parts will conduct the heat more rapidly from the working point; to offset this loss of heat a larger tip is used. In many cases, the tip should be as small as compatible with good work, to economize in the use of gases. If the flame is too small for the thickness of metal being welded, the heat will be radiated almost as fast as produced, hence the flame will have to be held so long at one point to effect a weld that the metal will be burned. On the other hand, if the flame is too large, the radiation may be insufficient to prevent burning the molten metal. The tip should have an opening that will reduce the metal to a plastic, molten condition (not too fluid), covering a width approximately equal to the thickness of the metal being welded.

Making Welds — For the student to become proficient in the art of autogenous welding requires experience and practise. A week's practise will enable any man to master the fundamental principles of it. It is advisable to begin by welding thin strips of iron or steel, not over $\frac{1}{8}$ inch in thickness, before attempting work on the parts of firearms. Such light metals can be welded without the addition of a filling-in material. The torch should be given a rotary motion accompanied by a slight upward and forward movement with each rotation. This movement tends to blend the metal and reduce the liability of overheating. If comparatively thick materials are practised on, the edges should be beveled (by chipping or in any other convenient manner). The beveled surfaces are then heated by a circular movement of the flame, care being taken to melt them to a soft plastic state without burning the metal. Wherever fusion occurs, new metal should be added from a "welding rod," the composition of which is suit-

able for the work in hand. In continuing the heating operation, the flame should be swung around in rather small circles and be advanced slowly to distribute the heat and prevent burning. The surface should be thoroughly fused before adding metal from the welding rods, and the latter should be held close to, or in contact with, the surface. The heat is then radiated from the welding rod to the work; whereas, if the metal wire is allowed to drop through the flame, it may be burned to an injurious extent. When the weld is completed, it is advisable to pass the torch over it, so that all parts will cool in a nearly uniform temperature.

When welding two parts together, it is important not to heat one more than the other, because the hottest piece will expand most and the weld may crack in cooling as the result of uneven contraction. In making heavy welds, the parts should be brought to a red heat for a distance of about three times the thickness on each side of the weld for thickness up to 1 inch, the distance being increased somewhat for heavier parts.

Pre-heating — Parts to be welded are often pre-heated by the use of a blow torch, gas furnace, charcoal fire, etc. This pre-heating is done either to economize in gas consumption or to expand the metal before welding, in order to compensate for contraction in cooling. Of course, you will never experience this requirement in gun work, but it is well to know the principle. Usually it is advisable to pre-heat in comparatively heavy, thick metals (especially if cast) before welding. This equalizes the internal strains, and very materially reduces the cost. In many instances it is much better to produce expansion before welding than attempt to care for the contraction afterwards. When there is a straight crack, it can usually be opened uniformly by heating the metal at each end and keeping it hot while the weld is being made. As a rule, the expansion obtained by heating at the ends will compensate for the contraction which accompanies the cooling. When a part has been pre-heated, it is well to place sheets of asbestos over it to protect the operator and prevent heat radiation, the surface to weld being exposed. Where a piece of metal has severed completely or a projection has broken off, pre-heating will not be necessary. Whether the metal is pre-heated or not, it should be covered as soon as the weld is finished and be allowed to cool slowly. If the metal is more than $\frac{1}{4}$ inch thick, the edges should be beveled at an angle of about 45 degrees on each side.

For comparatively heavy welds, it is well to leave three small points of contact for alining the

broken parts in their original position. To make the weld, the flame should be passed for some distance around the fracture and then be directed on to it until the metal is cherry-red. When this occurs, have an assistant throw on a little scaling powder, and when the metal begins to run, add cast-iron from the cast-iron "welding stock," which should be of specially refined material. Powder should only be added when the metal does not flow well, as little as possible being used. Never attempt to re-weld pieces that have been previously welded or brazed without first cutting away all the old metal.

Welding Steel — Steel less than $\frac{1}{4}$ inch thick can be welded without the addition of any welding metal. If the thickness exceeds $\frac{1}{4}$ inch the edges should be beveled or chamfered. It is very important not to add the welding material until the edges are fused or molten at the place where the weld is being made. The welding metals should be special wire, and in no case should the flame be held at one point until a foam is produced, as this is an indication that the metals are being burned. Do not hold the flame steadily in the center of the weld.

When welding a crack located in the middle of a piece of steel, such as a fore-end arm, begin by chamfering the metal on each side of the fracture at an angle of 45 degrees, the slope extending to the bottom. Then apply the welding torch to the fore-end arm beyond the end of the crack until there is sufficient expansion to open the crack perceptibly. The weld should then be made; as a rule it will be found that the expansion will compensate for the contraction when cooling. A slight excess of oxygen is less harmful than an excess of acetylene, but it is important so to adjust the gases that the flame is neutral. When the weld is completed, pass the torch over it and the surrounding metal, as previously mentioned.

Welding Brass — The gunsmith is called upon very often to weld this class of metal, especially on older arms such as the muzzle loaders. When welding brass, adjust the flame until there is a single cone, as for steel welding. Keep the point of the white flame slightly away from the weld, according to the thickness of the piece, so that the heat will not be sufficient to burn the copper in the brass or volatilize the zinc. If a white smoke appears, remove the flame, as this indicates excessive heat. A little borax should be used as a flux. For brass welding, it is advisable to use a tip about one size larger than for the same thickness of steel, for as the weld is really cast brass, it will not have

the strength of rolled sheet brass. Do not breathe the fumes while welding brass.

Welding High-speed Steel to Machine Steel — The student will very seldom get such work, except when making certain forming dies where it is necessary to have a special hard part to turn or form over the edge on a die. In order to weld high-speed steel to ordinary machine steel, first heavily coat the end of the high-speed steel with soft special iron, obtainable from the makers of welding outfits. This can be done without heating the high-speed steel to the burning point. After cooling, the high-speed steel can be welded to ordinary machine steel without burning, but experience is required to make a good weld of this kind.

When a gun shop is equipped with a welding outfit, it is rather expensive, as the equipment needed is one tank each of acetylene and oxygen, suitable gauges, and torch and rubber hose connection. However, if a considerable amount of welding is being done it pays to add this to the shop. You can accomplish a number of things with one of these outfits, from welding aluminum and copper to building up or filling in metal on parts which otherwise would necessitate making new pieces and require hours of labor. Such an addition would perform the required results in a few minutes. As a student in gun work you may be in a locality where you could take in welding work and pay for such an outfit in a short length of time, for you are able to cut metals as well as weld or braze these broken parts together.

Cutting Metals with Oxidizing Flame — The oxy-hydrogen and oxy-acetylene flames are especially adapted to cutting metals. When iron or steel is heated to a high temperature, it has a great affinity for oxygen and readily combines with it to form different oxides, which cause the metal to disintegrate and to burn with great rapidity. The metal-cutting torch operates on this principle. Ordinarily, two jets or flames are used; first there is an ordinary welding flame for heating the metal; this is followed by a jet of pure oxygen which oxidizes or burns the metal. The kerf or path left by the flame is suggestive of a saw-cut on some torches. The oxygen jet is obtained by the application of a separate cutting attachment to a regular welding torch. This attachment is little more than a pipe containing a tip which supplies a pure oxygen jet close to the regular heating flame. Torches are also designed especially for cutting.

Operating the Cutting Torch — When starting a cut, the steel is first heated by the welding flame,

then the jet of pure oxygen is turned on. The flame should be directed a little inward so that the under part of the cut is somewhat in advance of the upper surface of the metal. This permits the oxid of iron produced by the jet to fall readily out of the way. If the flame were inclined in the opposite direction or in such a way that the cut at the top were in advance, the oxid of iron would accumulate in the lower part of the kerf and prevent the oxygen from attacking the metal. The torch should be held steadily and with a cone of the heating flame just touching the metal. When accurate cutting is necessary, some method of mechanically guiding the torch should be employed.

The maximum thickness of metal that can be cut by these high-temperature flames depends largely upon the gases used and the pressure of the oxygen. The thicker the material, the higher the pressure required. When using the oxy-acetylene flame, it might be practicable to cut iron or steel up to 7 or 8 inches in thickness, whereas with the oxy-hydrogen flame the thickness could probably be increased to 20 or 24 inches. The oxy-hydrogen flame will cut thicker material principally because it is longer than the oxy-acetylene flame and can penetrate to the full depth of the cut, thus keeping all the oxid in a molten condition so that it can easily be acted upon by the oxygen cutting jet. A mechanically guided torch will cut thick material more satisfactorily than a hand-guided torch, because the flame is directed straight into the cut and does not wobble as it tends to do when the torch is held by hand. With any flame, the cut is less accurate and the kerf wider as the thickness of metal increases. In cutting light material, the kerf might not be over $\frac{1}{16}$ inch wide; whereas,

for heavy stock it might be $\frac{1}{4}$ or $\frac{3}{8}$ inch wide.

A few of the purposes for which cutting torches are commonly employed are as follows: for cutting steel wreckage, steel piling, steel beams in structural work, risers from steel castings, and openings through steel plates. These torches are never used for such work by the gunmaker, except in the manufacturing division in the tool and die department, to cut die openings in the die plates, etc.

High and Low Pressure Torches — The difference between high and low pressure oxy-acetylene welding and cutting torches, according to the generally accepted meaning of these terms, is the pressure of the acetylene gas. The oxygen, in each case, is under a pressure of one or two atmospheres. With a high-pressure torch, the acetylene has a working pressure of one point or more (depending upon the nature of the work); in the low-pressure type, the acetylene gas only has a pressure of a few ounces. The operation of the low-pressure torch is on the principle of an injector, in that the jet of oxygen draws the acetylene into the mixing chamber which is the torch tip. The proportion of oxygen to acetylene varies somewhat with different torches; it usually ranges between 1.14 to 1 and 1.7 to 1, more oxygen being consumed than acetylene.

With the foregoing information, the student can accomplish such work most economically when only a small amount is to be done. In doing any welding or bending on bolts, the working parts must be protected with moist asbestos or some other protective material. There are also processes of welding by electricity, but these are never used by the gunsmith.

CHAPTER XXVII
Field Repair Kits
and Devices

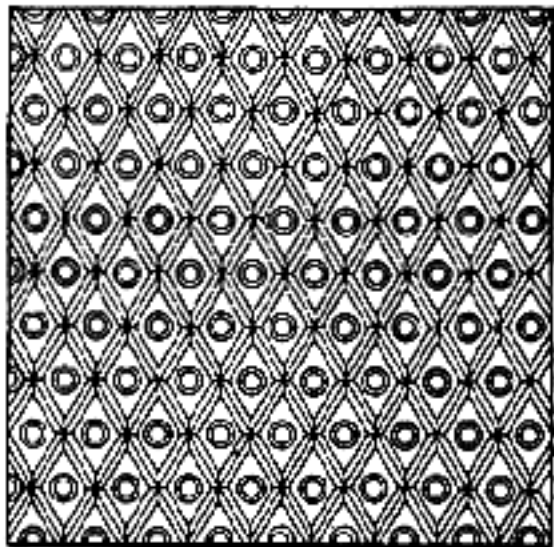

Field Repair Kits and Devices

EVERY man who plans for a long hunting trip should be well prepared to accomplish any one of a number of small field repairs on his equipment, for altho the fine arms of today are constructed from the best steels, accidents do happen, and when the individual who is unable to make repairs has the misfortune of breaking or damaging his gun during the trip, he is indeed in a bad way. The repairs that can be made on any arm depend, of course, upon the implements available and the resourcefulness of the hunter. For any well-planned expedition, regardless of its length, there are certain things that everyone should carry and certain facts that he should know. The outfit should contain those accessories needed for properly taking care of arms, such as cleaning rods, oil, bronze cleaning brushes, grease, and flannel patches. Spare parts should also be included for those parts which are most likely to break on a rifle or shotgun. The essential ones for a bolt-action rifle are: striker, extractor, ejector, magazine spring, and shell extractor; and for a shotgun or double rifle, a set of strikers, extra main springs, and top lever spring.

A repair kit composed of various small tools and spare parts is a convenient if not absolutely essential addition to any well-planned trip. When a particularly long and hard journey is planned, a special box should be made similar to a shooting bag, but of fiber, or made like a small suitcase with good strong straps. Just what kind of kit is to be carried depends on how extensive the hunt is to be. The man who is only out for a week includes only the bare necessities; but on a trip to last a month or more, he should be on the safe side, collect a number of tools, and place them in a small shooting bag or fiber case. Even tho they are not used at that particular time, they will be of service elsewhere. The hunter himself should decide just what tools the kit is to be composed of. If he cannot compile a list for himself after he has become familiar with the vast number of tools described in these volumes, then all I can suggest is that he carry along an extra gun—to take care of any emergency that might arise—or include a trained mechanic in the party. So, instead of giving a list of tools, I will here offer

some suggestions that should be far more useful.

Repairs to Broken Stocks — One of the most serious accidents which can happen to a gun is the breaking of the stock at the grip. However, such a break is easily repaired in the field, even tho it be in some isolated and wild country. It may be securely spliced in a number of different ways. First, glue the stock as well as possible and wedge in such a manner between two objects that when the glue dries it will be possible to work around the break. Cut grooves parallel to the break and lay into these grooves pieces of hardwood cut from the surrounding section—if in the tropics, bamboo splinters may be used. Glue these into the grooves, allowing the splices to stand well above the stock; tightly wrap twine or wire around these and again allow the glue to set. When it is dry, remove the binding, whittle down the splices flush with the stock, and then tightly wind wire around these; or if not wire, then wax thread, fine leather lace, or green rawhide. Green rawhide, regardless of the animal from which it was obtained, has been very well known, especially to the western pioneers. This has been used for many purposes, even to building corrals; for when once dry it is as strong as any material known. Cut the green hide in strips and tightly bind and tie each piece, allowing the hair to remain on the outside; or the hair can be removed first by soaking the strips in warm water and wood ashes. Scrape both sides, wipe the laces dry, and bind these around the breaks. When completed, place the stock upon two forked sticks over a wood fire, high enough so that the flames cannot reach it, and the heat from the fire will dry this rawhide as hard as iron.

It often happens that a break is straight across the grip. In such a predicament, without rawhide or glue, various other means of a primitive nature must be found. Rosin and gums from various trees may be collected, together with strips of strong bark or vines. Splints are made and these interlocked along the sides of the break below the surface. The necessary grooves can often be made and dovetailed with only a pen-knife. When all parts are in place, insert the gum or rosin and bind the outside with the strips of bark or vines

until a solid strong joint is formed. It requires ingenuity to improvise with the help of nature, but such efforts will improve your skill.

Action or Top-lever Breaks — Shotguns and double rifles are most likely to be put out of commission. The action or top-lever spring often breaks, but this should not in any way affect the utility or safety of the arm. It will merely mean that you move the top lever into the locked position when the gun is closed, instead of snapping it as you have been accustomed to doing. A rubber band may be placed on the lever as a means of reminding you to lock the lever completely in place, even tho the band acts as a rough spring. The strikers or firing pins in ordinary shotguns and double rifles will become useless after continuous wear, owing to the hardened tumbler flattening the head of the striker, shortening its travel, and causing frequent misfires. Before starting on a trip with such arms, always have a set of extra strikers made from the best spring or chisel steel to replace the original strikers when this occurs. In guns in which tumbler and striker are one and the point itself strikes against the primer of the cartridge, the flattening of the striker does not occur and breakage is rare.

Dents in Shotgun Barrels — One of the most common accidents to shotguns far from the beaten path is the denting of the barrels against rocks, etc. Whenever the dent is a bad one, *do not try in any case to shoot the gun until the barrels have been repaired*, for firing out a badly dented barrel invariably causes the barrel to bulge considerably and oftentimes fractures it at the dented section. The following instructions are most expedient for removing the dent: After removing the barrels from the action, insert in the dented barrel a wooden plug whittled from hardwood to a size close to that of the bore, and taper it on one end. Insert from the chamber end and pass it forward with a wooden rod made for that purpose—or even with a good cleaning rod with the brushes removed. Pass it forward until the obstruction caused by the dent is reached. If the barrel is lightly hammered with a small hammer and the pressure on the inside maintained by forcing the plug past the dent, the bulge may be raised. It may be necessary to use various-sized plugs and repeat the operation until the barrel is as near normal as possible. The barrel should be warmed during the process by applying a hot iron to the outside of the dented or bulged part, especially when it is a bruise that reaches deep. Be very careful not to get the plug caught in the barrel. If a lead plug can be

made, the operation will be greatly simplified; and a slightly tapered iron or brass plug is much better than a soft lead one. If a hard metal plug can be obtained near the required size it can be rolled with paper until of the correct diameter. The plug should be larger than the bulge or dent.

Repairs to Bolt-action Rifles — On bolt-action rifles, there are usually four parts which need replacement; shell extractor, shell ejector, magazine spring, and striker or firing pin. If any of these should break, it would be preferable that it be either the magazine spring or ejector. If either one of these is broken it makes the gun only a single-shot arm, which is rather an annoyance whenever more than one shot is required, but a broken extractor or striker puts the arm completely out of commission. A broken ejector requires the removal of the fired shells with the fingers, and to make a substitution on a Springfield rifle means disassembling the arm to drive the keeper pin out. Therefore, a good screw-driver is necessary to take out the front and rear guard-screws. To remove the pin, drive out from the top side and place new ejector in position. The Mauser action is simpler, as only the screw is removed from the bolt stop, sliding out the ejector. The replacements of all these parts can easily be accomplished in the field except for the Springfield ejector, and that can be done if it is possible to secure the Government screw-driver which is a standard supplied for Springfield rifles as a field screw-driver.

The above replacements can often be carried in the butt stock of a rifle, even tho they do add a little weight to the arm, for it often happens that just such a part is needed at the most unexpected time. The inexperienced man may say, "I would never load my rifle down with such useless parts." Perhaps he may never have the experience of a broken rifle in the field, but it is the canny individual who looks ahead and uses every precaution to keep some slight mishap from ruining his entire trip. Let a small accident occur to the person who never thought this preparation necessary, and on the following trip he is the most careful of men. It takes the unexpected to teach a hard and well-learned lesson.

Sights — Extra sights are one of the most necessary things to carry on any trip, particularly the frail and thin-blade front sights with small ivory and gold beads. All front sights should be placed in their position with a screw that can be easily removed with a small screw-driver. Most factory arms have their sights fastened by small pins

driven through the base and blade. Such an arrangement should always be looked over before the trip, as a pin is next to impossible to remove in camp without the proper means of holding the muzzle firmly. For this reason screws are preferred. As there are a variety of rear sights it will be a hard matter to give any instruction on these. The three different types are the leaf, aperture, and telescope. These, of course, can become damaged in various ways, but as there is always a means to straighten, tighten, or bring them back in alinement, I shall not offer any suggestions except for a particular type of emergency sight. Leaf sights set in a base on the barrel are usually a form of emergency sight resorted to when an aperture sight is used. If the leaf sights fold down on the base when not in use, it is very seldom possible to damage them in any way, even from a bad fall. As they fold they have a spring to hold them both in an upright and retarded position, and there is never any danger of their being at a half-way point to catch upon any object. When wanted for use, all that is required is to snap them into position with the fingers. Those who use an aperture sight may never require the use of this, altho it is a means of checking the peep-sight. The curious person around camp is usually tempted to fool with the knurled nuts; occasionally the spring becomes weak and allows the windage nut to turn when the rifle is withdrawn from the saddle scabbard or carrying case. Such little accidents have happened, and because of this a man has often had his whole trip spoiled by shooting and missing the only animal seen upon the hunt. After checking up for the reason, the windage is found to have moved. But with a leaf sight set in line at the same range as the aperture, it can be snapped into position at any time if you are in doubt of the rear after it hits an object. By often checking the aperture with the leaf sight, you know that all are in perfect alinement, thus allowing for the best shots.

When a rear sight becomes damaged or broken off entirely because of a very bad accident, it usually requires a considerable amount of ingenuity to make a temporary sight; as this is a rare occurrence, the sportsman must provide means of making a sight out of the material at hand. His success depends upon just how much he provided for such a happening.

Obstructions in Barrels—Getting foreign objects lodged in the barrel of a gun is a well-known source of annoyance and often a dangerous one. Snow, mud, and cleaning patches are three things which are the greatest offenders; a parted car-

tridge case in the chamber is movable. For the latter, it is best to carry a broken shell extractor, which will always remove parted cases—unless you have a bad chamber, in which instance you must consider a rifle completely out of commission unless you have provided for such an emergency as described in Chapter XVII, Volume II. A good strong steel-jointed cleaning rod having short joints, which fit into the recess under the trap-butt plate, should be a part of every hunter's equipment. It adds considerable weight to a rifle, but it is often worth its weight in gold when mud or snow collects in the bore far from camp. The short-jointed cleaning rods made from $\frac{7}{32}$ -inch drill rod, neatly made in joints of 6-inch lengths, are essential in making hunting trips successful. Chapter II, Volume II, contains illustrations of the $\frac{9}{32}$ -inch cleaning rod made in 10-inch lengths for the caliber .30. These when screwed together form one continuous solid rod to be placed in the cleaning or emergency kit. When screwed apart they take up very little room. A pull-through is also very handy for wiping out oil, water, etc., or for oiling the inside of a barrel when away from camp for a few days. This method of cleaning a rifle has been in practise in the army for a number of years, and a specially made container has been devised to hold a pull-through on one end and an oil can on the other. This can be fitted into a recess under the butt-plate trap, and, being very light in weight, entails no inconvenience. These are rather expensive to produce as a commercial product, but any member of the N. R. A. can secure one, and they are well worth the trouble to have them inserted under the trap in your sporting rifle.

Occasionally in some isolated districts a cleaning patch will become stuck in the bore. In view of this, it is well to make a tip to screw into the end of the cleaning rod. A wood screw may be used for this purpose; turn down the head and thread it to fit into the tip; by inserting this into the bore and turning it into the obstruction, the latter can usually be removed with very little effort. Such tips should be a part of all regular cleaning equipment.

Individuals who have been allowed to use a gun from childhood make the most careful sportsmen and shots. It is only the tenderfoot who fools with firearms. The adage, "Familiarity breeds contempt," does not apply to the knowledge of weapons, for the person of the "didn't-know-it-was-loaded" variety is usually someone who has had little to do with firearms. To point a gun at any person should in itself constitute a criminal offense. All weapons must invariably be treated as if loaded, not only for the safety of your com-

panions but for that of yourself as well. In time this rule should be so imbedded in your mind that it almost becomes a religion. A state of complete self-possession is acquired through practise and the wise individual will not venture to shoot with his fellow men until that time comes. Remember that there is time for a shooter to make sure that every shot fired is aimed in the safe direction, and this without interfering with the rapidity or accuracy of the aim.

The student should practise handling an unloaded gun until he can bring it up sharply and well to cover any object at which he is looking. In shooting, as in other sports, ease of movement is the first requirement; this is only attained by practise in snap shooting. To become proficient in the use of a gun, it is advisable to handle a rifle such as the Springfield a few minutes a day, and snap the trigger, which does not harm this arm in the least. However, on a shotgun a snap cap must be used. This practise should be adhered to very earnestly for at least two months before the hunting season opens.

To do this snap shooting, it is best to take a good position, like that of an expert at the traps; the left foot slightly in advance, the knees straight, the body slightly forward from the hips, the left shoulder brought well forward, allowing for a longer reach with the left hand. The gun must be grasped firmly with the right hand, the index finger on the trigger; the left must be brought as far forward as will permit the arm to be quickly manipulated, the gun being held well across the body. The left hand held well forward on the forearm gives a better command over the gun, especially with respect to its elevation; but if it is too far forward, it retards a change of aim from left to right. Through these suggestions, new ideas will develop and the beginner will eventually have the greatest respect for all firearms. He will always demand the best from the standpoint of durability and beauty, the precision of which he can admire every day in the year.

While we are on the question of the selection of tools, study Chapter XVII, Volume II, and the question of cleaning equipment and chest which I made for Colonel Whelen. So elaborate a chest is not required, but the tools it contains are essential. These have been described in the chapter on cleaning bores and removing obstructions. A tool kit should contain the means of repairing any anticipated breakdown. Often a number of the same tools can be used from your home workshop, and if you intend to make frequent journeys away from the beaten track, a duplicate set may be collected for just such purposes. Screw-drivers are

among the most essential tools, and it is well to carry some extra screws, for they are apt to become lost; or perhaps the threads may become stripped from long use.

How often has one expressed the wish for a vise for some repair in camp! While making the wish you may have been sitting upon the very material that nature has supplied for one. To make a satisfactory vise, study Figure 148-a, which is self-

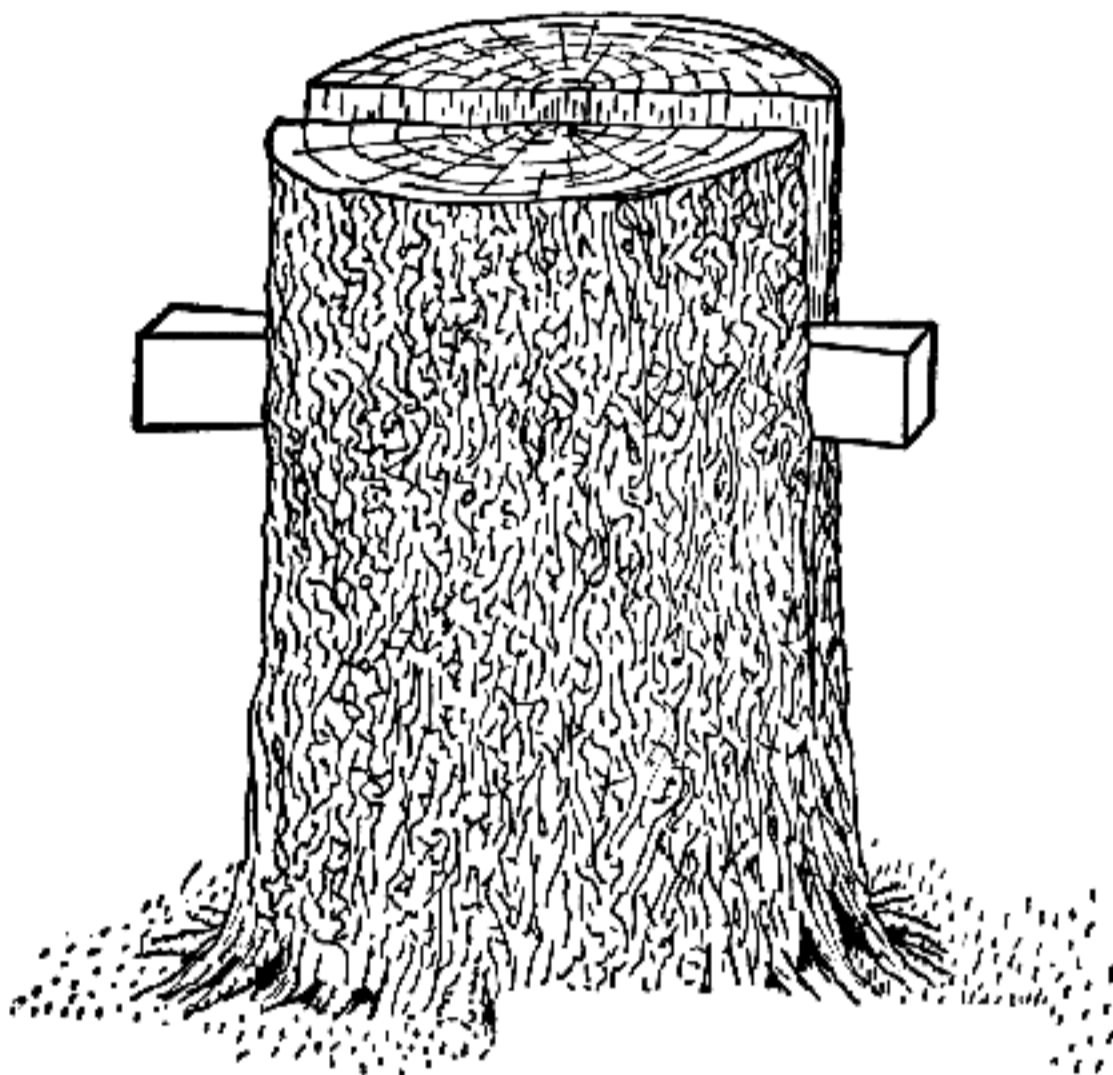

Fig. 148-a

Field vise. A very effective means of holding parts in an emergency

explanatory. It is not necessary to cut down as large a tree as the illustration shows, but one which will be sufficient for the holding powers to clamp the object you may want to work upon. Before splitting the stump, make two wooden wedges; and for the split, insert the wedges and drive them in until the opening is large enough to hold the part. The spring of any tree trunk will hold an object solidly while the work is in progress, whether sawing, filing, or driving out pins. Even small parts can be filed in this manner; therefore, such an idea is well worth remembering.

Before going on a hunting trip all extra front sights should be inserted in the slots and the weapon sighted in. Mark the exact location with a finely scribed line or a fine chisel mark. Then, when it is necessary to make the replacement, there will be no need of too many sighting shots being fired.

I have been trying to impress upon the reader's mind that tools for emergency repair jobs are important, but I do not mean that the equipment

should be littered with numerous non-essentials. By using a little intelligence you can judge for yourself what will be useful to you and what will be merely so much junk. If our forefathers existed hundreds of miles from civilization without even a

screw-driver in their packs, and with arms made of the cheapest material, certainly we with the advantages of our fine arms can manage with a kit that can be rolled up in a specially made container to be carried in a back pocket.

CHAPTER XXVIII

Experimental Factors Governing Small Arms and Ammunition

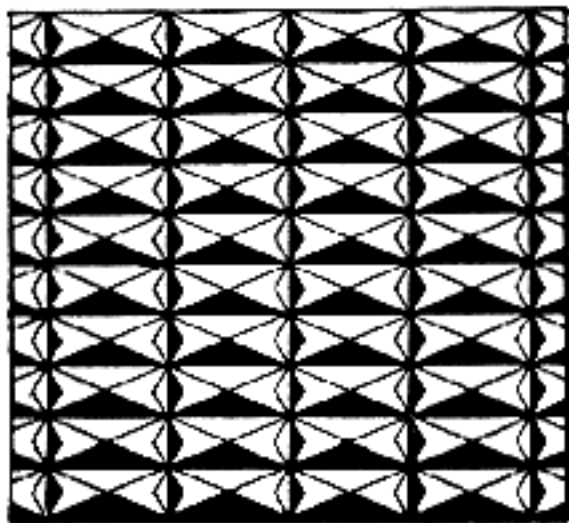

Experimental Factors Governing Small Arms and Ammunition

WHILE this chapter will deal almost exclusively with the experimental designs governing sporting arms and ammunition, interest and profit may be derived from special notes on all parts in relation to the success leading to such developments. Glancing briefly at the effect of military influence on our production of high-velocity ammunition as well as the arms to handle it, we find that it was not long before the merits of the caliber .30 Model 1906 cartridge men became conscious of the advantages conferred by the absence of smoke, the light weight, and the error-absorbing qualities of the low trajectory at ranges outside the scope of the most efficient black-powder weapons. These advantages were no less appreciated by the more progressive rifle makers, who were also conscious of limitations as regards stopping power against dangerous game, and sought to make good this palpable deficiency by means other than bullet designs. In place of the well-tryed .600, .577, .500, .475.2, .465, .450, .400, .375, and .350 caliber express rifles, now stands a range of weapons using cartridges which combine the advantage of the absence of smoke, sustainable recoil, and low trajectory over short sporting ranges, with adequate bullet weight and tremendous smashing power.

Cartridges suitable for big game of all varieties, ranging in calibers from the .600 express with its 900-grain metal-patched bullet and 7600-pound muzzle energy, down to the .22 caliber Hornet with its 45-grain bullet, developing a muzzle velocity of 2600 foot seconds, the smallest representative of the high-power class. In spite of the recorded performances of a cartridge of this type, it is considered that their use, except in an extremely limited role and by very experienced hands, is likely to lead to many disappointments. Military cartridges are designed to serve a definite purpose, whereas the uses of sporting cartridges are many. It is an unfortunate fact that a great deal of misconception exists regarding the correct interpretation of ballistic data, with the result that disappointment is often due simply and solely to very gross overtaxation of the capabilities of even the most efficient small-bore bullet.

Before these general remarks give place to the more detailed aspect of modern cartridge and rifle

experimental factors, a few brief remarks on cartridges containing their own means of ignition other than center fire may be of interest. The rim-fire design came into use during the time of the Civil War for the Spencer and Remington arms. It is now almost exclusively confined to the popular .22-caliber cartridges, and being ill-designed to withstand high pressures it is never likely to be the subject of wider application. Another fault lies in the large quantity of priming composition that must be employed, which often produces serious erosion in the absence of the latest developed priming composition. Absence of opportunities for the exercise of extreme care and attention in cleaning the barrel after use usually results in disappointments; therefore, it is difficult to place such a cartridge in a class for future developments, except to use it in connection with experiments which will answer for a certain factor to make an experiment successful, such as in an explosive bullet.

One of the most important modern advancements is in the direction of "boat-tailed" bullets, "streamlined," as they are popularly styled. The Swiss can be credited with the idea; but we at the Frankford Arsenal explored the possibilities of a boat-tailed bullet, and developed it to what may be regarded as the most up-to-date and successful example of fine accuracy. The ammunition companies were not dilatory in placing this type of bullet before sportsmen of the United States. The United States adopted this bullet in place of the service 150-grain flat-base bullet about 1923. Switzerland had begun using it in her service about 1912, and it soon came to be regarded by all nations as the most modern and successful of all boat-tailed bullets for military purposes. A study of such projectiles is evidence of recognition of the ballistic advantages derivable from the employment of the rear taper from four to twelve degrees. Figure 149 illustrates such a bullet in flight.

Target shooters who limit themselves to service or National Match rifles, as well as heavy match barrels requiring sights and methods of considerable refinement, may well interest themselves in exploring the possibilities offered by improvements of the cartridge bullet, and barrel for better accuracy. Figure 166 shows a flat-base bullet in flight. Note

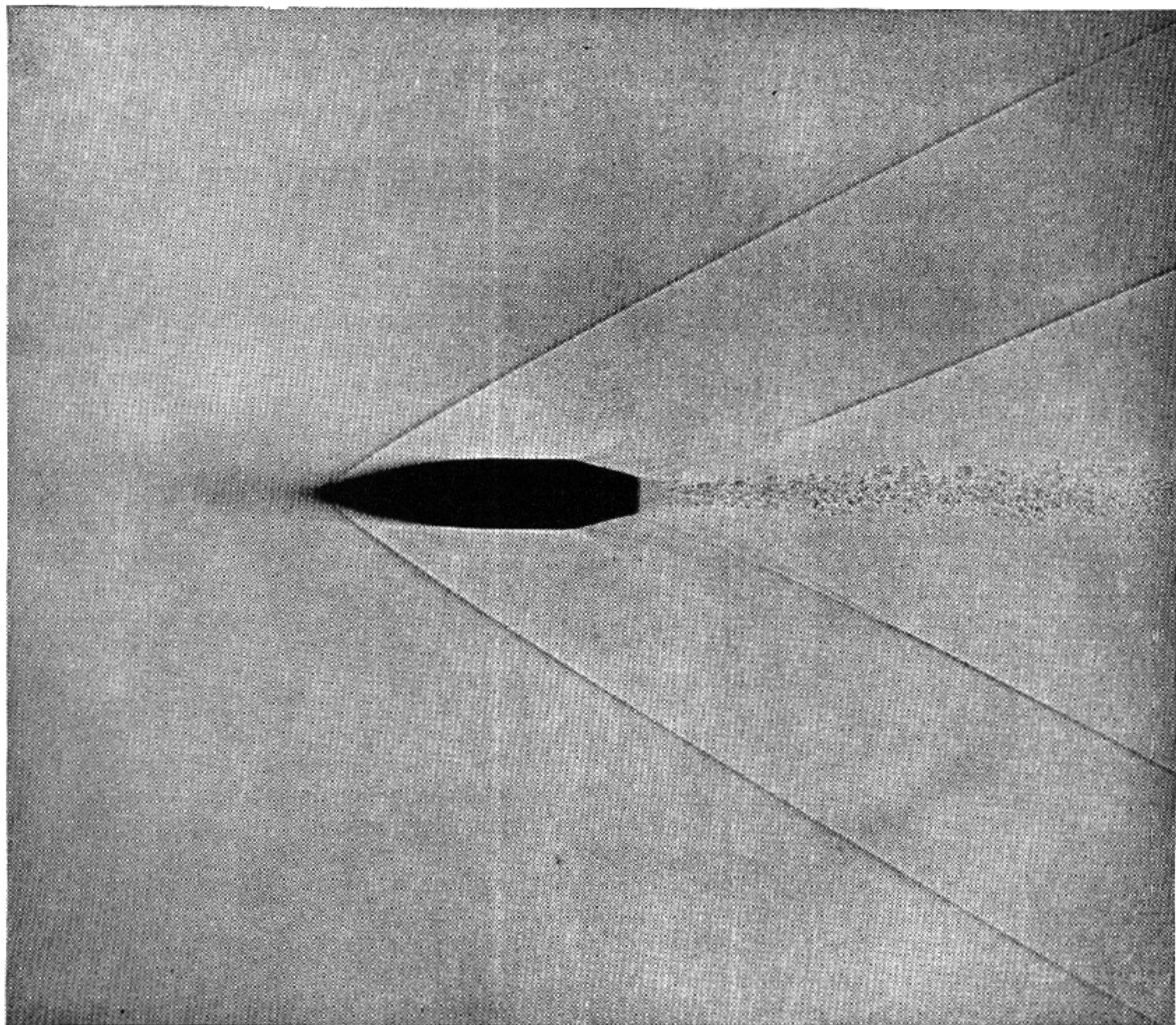

Fig. 149

View of a caliber .30 boat-tailed bullet in flight—the result of Dr. Dayton C. Miller's study on this subject. Note the effects at the base, of stream-lined design, in air resistance

the difference in the rear vacuum as compared with the boat-tailed bullet.

The Cartridge Case — The problem of designing a military cartridge case as well as the bullet is much more simple than the corresponding problem for sporting purposes. In the latter case a complete and accurate knowledge of the behavior of all propellents under all conditions is required because of their many kinds. In the former case the conditions are so strictly limited that there is but little scope for radical changes from existing models.

In a cartridge case for military arms as opposed to sporting rifles the limits of size and weight are all-important, and the problem is confined to a design of maximum efficiency. Therefore, one point

is completely determined; the cartridge case must be as full of powder as possible, otherwise weight and space are wasted in carrying a cartridge case larger and heavier than that which is absolutely necessary.

The design of the cartridge head is an important feature, and the principal types are illustrated in Figures 150, 151, 152, 153. Countries which use a head such as that shown in Figure 150 are France, Russia, Great Britain, Roumania, Holland; it is also used in a number of sporting cartridges, especially those used in large double express rifles as well as sporting cartridges of smaller caliber. The cartridge is held in position in the chamber by the front of the rim or flange bedding on the face of the barrel. This type is made expressly to avoid failures caused by wear of the chamber or short length

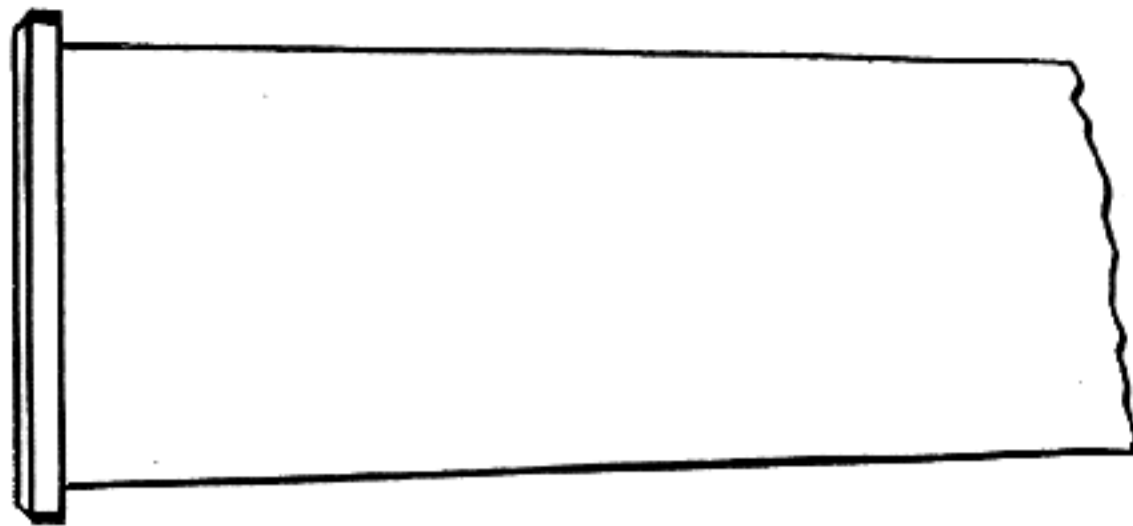

Fig. 150
Rim cartridge case

of cartridge case. Greater tolerance between the head and shoulder can be given in the manufacture of such a case. This cartridge is less expensive to manufacture than the rimless, but for the manufacture of rifle and machine guns or automatic arms the projecting rim requires more expensive tools. A rim case is hard to feed, because the rim catches on other cartridges or other projections while being fed from the magazine to the chamber.

Figure 151 is the rimless cartridge case as used by the United States, Switzerland, Germany, Italy, Spain, etc. This type of head is becoming standardized, not only in military cartridges but in sporting cartridges when a new case is designed. The

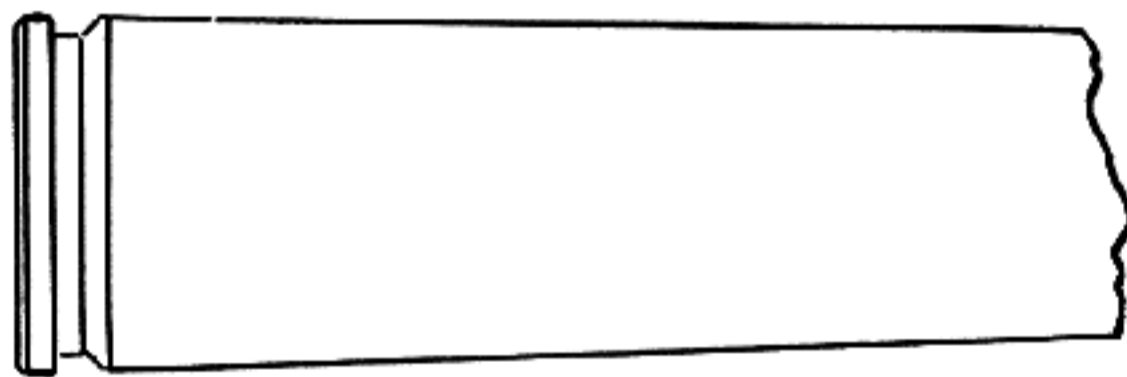

Fig. 151
Rimless cartridge case

cartridge rests in position in the rifle chamber by reason of the fact that its shoulder forms an abutment against the chamber shoulder, which acts as a positive stop. Such a cartridge case is slightly more expensive to make than the rim type, but packs, "feeds," and extracts more satisfactorily. The extractor groove must not be too deep or the head will be unduly weak.

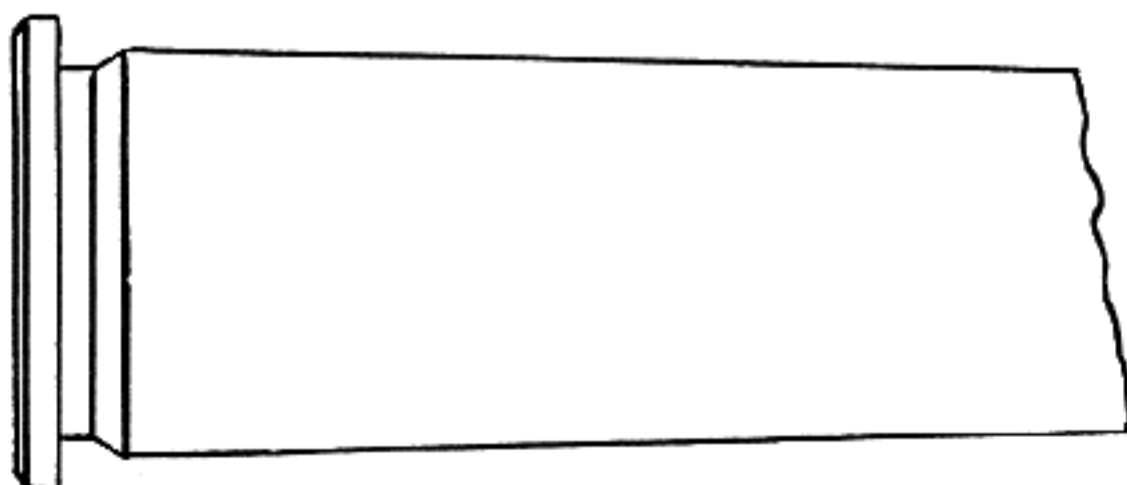

Fig. 152
Semi-Rimless: such a design is questionable

Figure 152 is the semi-rimless, which is between

a rim and rimless case. This form is intended to provide the certainty of position of the rimmed case without the disadvantage of a prominent rim. The success of its attempted compromise is very questionable.

Figure 153 is the belted type, an attempt to strengthen the case if it is at the rear, which is only a compromise for the allowance of metal on the inside of the case. The metal formed as a band on the outside could be placed on the inside, making greater strength and at the same time allowing

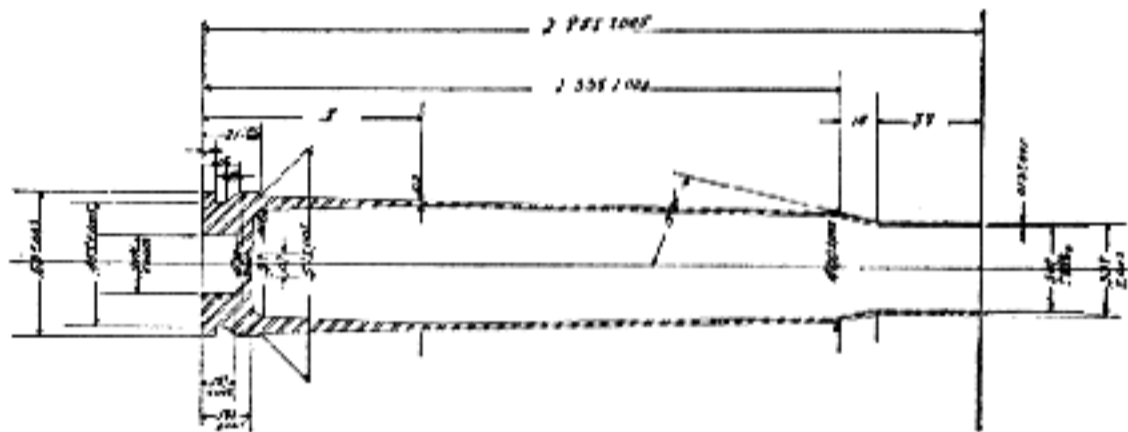

Fig. 153
Belted cartridge case: a design intended only for sporting-rifle cases of large caliber

a case with no projection. Cartridge cases of this design are only suitable for sporting arms; they do not meet all military requirements.

Primer Pockets — The primer pocket and flash hole or "vent" are provided to conduct the primer flash to the powder charge. Anvils are integral with the case when Berdan primers are used. The contour of the anvil is very important, as well as the location of flash holes, when this form of primer pocket is to be used. All American manufacturers of cartridge cases use the center flash hole of 0.08-inch diameter and a square-bottom primer pocket, allowing the anvil as a separate component. The diameter of the primer pocket or chamber is subject to certain limitations, particularly in the rimless design of case; therefore, the greater diameter is 0.250-inch, which can be combined with the deep extractor groove. The form of metal ring separating the two may be insufficient to withstand the back-thrust without undesirable expansion and allow the primers to drop out in extraction.

The primer pocket used for the Berdan type of primer with the anvil in the center of pocket has two needle-like flash holes no greater in diameter than 0.03 inch, whereas, all American-manufactured cases have the 0.08-inch center flash hole. Such a large diameter of vent is required for reasons of anvil obstruction in the primer itself, which does not allow a direct route into the vent. In a case with the center anvil integral and two needle-like flash holes on the side, there is a greater tendency for a more even ignition of the propellant charge.

Figure 143 illustrates this point between the two types of primer pockets. In the Berdan type there is a tremendous pressure set up at the instance of the ignition of the detonation charge. The two needle-like holes for the flame to rush through enable the flash to travel into the powder charge. This is what is called twin ignition, and at the peak of the high pressure very little back pressure escapes into the primer pocket; such pressure would tend to enlarge the pocket and allow the primer to drop out in extraction. The large flash hole in our American cases enables the gas to return into the primer pocket with a pressure equal to that inside the case, allowing expansion of the pocket in many instances. What is really required in a primer pocket where the anvil is a separate unit, is two flash holes needle-like in diameter, placed at an angle starting from the edges of a slight depression at the bottom of the primer pocket. Not only would the gas flame be hotter as it passes through the two holes, but it would penetrate the powder grains at a greater speed.

The question may arise as to what other means of detonation could be satisfactorily used in place of our present means of primer ignition. Naturally, the first suggestion would be an electrical contact. This idea was experimented with at the Frankford Arsenal and found unsuited to small-arms requirements, and it is questionable if such an idea could ever be satisfactorily worked out in view of the many complications entering the design.

Automatic Arms — The necessity for automatic weapons has become an accepted fact since the World War. Such an arm for sporting purposes should be banished altogether, owing to its destructive effect on our fast-disappearing game. The only field open for it is in military operation, whereas the experimental field is only open to those who wish to produce a more efficient weapon. To this end a brief consideration of the evolution of design may assist the experimental engineer. Men working on experimental designs often desire such information.

The primary object of any automatic arm is the economical development of fire control in the hands of excited men in action. Tactics with a new weapon are necessarily in the main only experimental. Still, tactics and design must be mutually reliant, and therefore the design of such a weapon must be influenced by the tactical needs which it is intended to satisfy rather than by considerations of purely mechanical efficiency. During time of war the process of design keeps pace and is more or less ruled by the needs of the moment. During the long periods of peace time, needs are only studied and

tend to reach a condition of eliminative compensation and stability. Thus it remains true that for general purposes any new weapons are involved with actual experience with the experimental arms.

These automatic arms can now be examined more thoroughly at the Springfield Armory, as they have become a standard for the United States Army in the caliber 0.30 class. Their advantages and disadvantages can easily be determined. We discover that the rush of gas through the barrel at so high a temperature causes a slight evaporation of the metal surface, which is a wasting of the metal. To neutralize this condition, the barrel alloy should be made near to a high-speed steel similar to that used for cutting tools. The wear due to functioning of the bullets could be considerably reduced by making barrels of steel with a high tungsten content. The manufacturing difficulties will be greater than with the standard barrel steel now in use; the principal obstacles will be found in obtaining suitable cutting and rifling tools, the long time necessary for machine operations, and the consequent increase not only in the labor involved but in the expense of the steel as well. With the advance of time it will be found a simple matter for some of our large steel mills to work out a suitable steel for this purpose.

Constant lubrication of the bore reduces friction. Various methods have been tried in experiments with the service arm, including greasing the bullet and oiling the entire cartridge; but so far it has been found that the objections far outweigh the slight gain. Grease and oil collect grit and are also liable to be rubbed off, while if the bore is to be lubricated at all it is essential that the lubrication be consistent; otherwise accuracy is impossible. A far more harmful effect is met with when any form of lubricant is allowed to remain in the chamber; therefore undue stress is thrown on the breech mechanism through the failure of the case to grip the walls of the chamber, while extraction may be found more difficult through the carbonization of the lubricant and the collection of grit. Figure 154 shows how the breech pressure is increased on the head of the bolt.

The firing of special ammunition such as Tracer, Incendiary, Armor-Piercing, and other ammunition of a similar design, is liable to form abrasives, as some bullets contain chemical compositions, the reaction of which, in many cases, commences before the bullet has left the barrel and may have a very injurious effect on the metal. These facts have increased the importance of the essential part of the weapon—the barrel—demanding not only that it be made of special steel but that the metal be treated

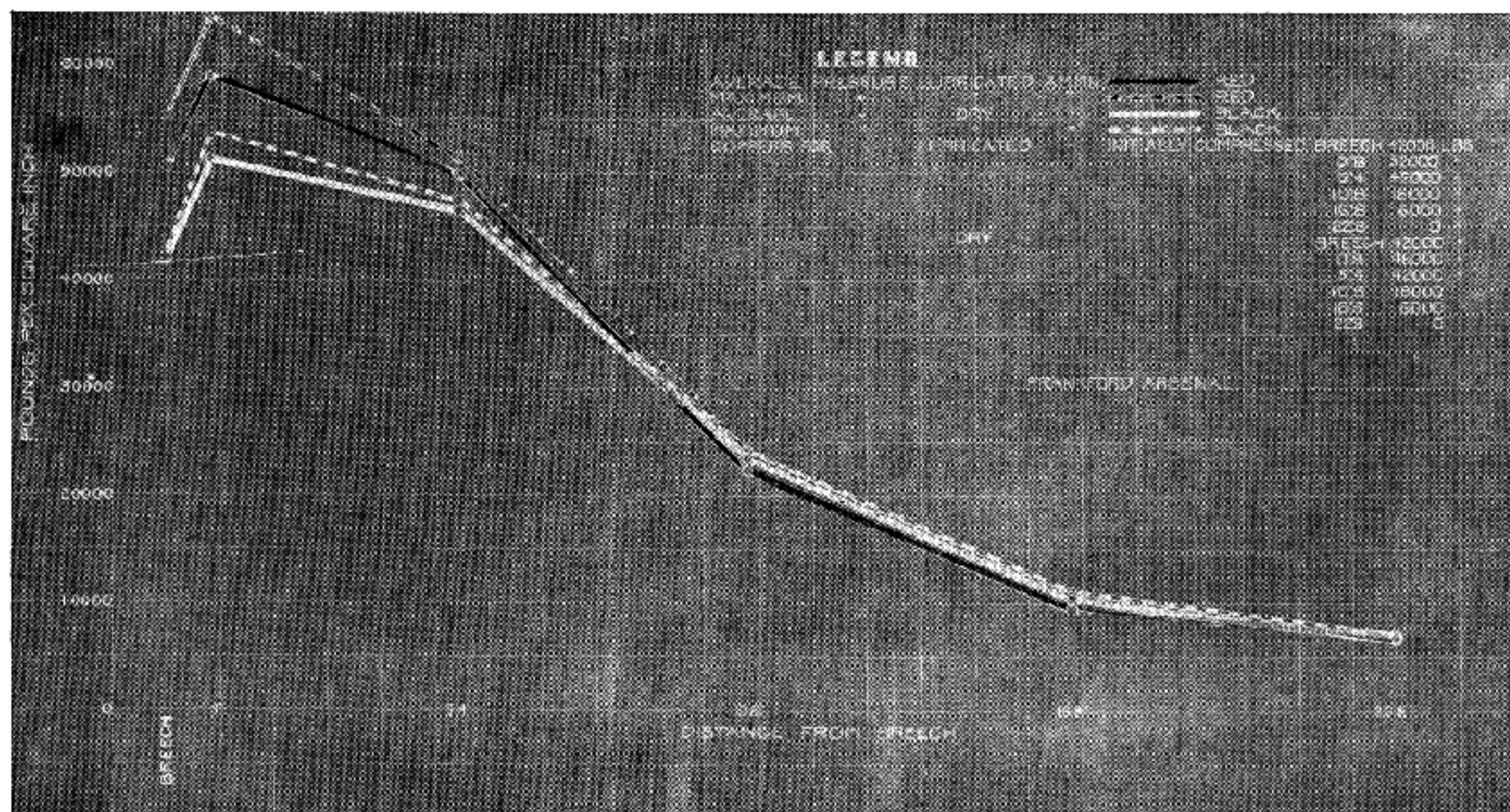

Fig. 154

Chamber pressures of lubricated and dry ammunition. Caliber .30 National Match flat-base bullet. Note how suddenly the pressure curve rises when the case is given a slight film of grease

with some substance in the bore to reduce friction to the lowest possible degree.

The modern tendency in designing an automatic arm is to arrange the components so that they interlock with each other; this has the advantage of eliminating a considerable amount of nuts, pins, and screws which are always becoming loose. Any attempt toward inaccessibility must, of course, be avoided, or else delay may be introduced by the replacement of worn or broken parts.

The design should be such that the arm cannot be made to fire unless the action is fully closed and the cartridge properly supported, *i.e.*, mechanically safe; even then it should only be able to fire through the operation of the trigger mechanism, or an arrangement of fire control, the efficiency of which must be proof against any undue cause, such as a sudden jar. Safety devices should be so applied that their function is accomplished by a single simple movement. The most efficient design, though not always practical, is one which positively prevents movements of the trigger and has no direct control over the firing pin or striker.

It may be found necessary to have a special type of ammunition. Odd designs are permissible for automatic arms when they are found advantageous; and further, in an automatic gun barrel that is vented for gas operation, the vent should not be a detriment to the functioning of any special types of ammunition; nor should the entrance of the vent

cause metal to be scraped off the bullet during its passage over the aperture, thus causing the closing of the vent by the accumulation of fouling. It would be a great advantage if all magazines could be carried separately and the interchange from empty to replacement made rapid without loss of time while in action.

It can easily be seen from the foregoing that it is not always practical to embody all the desired characteristics in one single weapon, as some of them are more or less mutually destructive. Further, the practical requirements which a particular arm is intended to fulfil influence the relative importance of the above considerations in its true design.

Having studied the characteristics of a supposedly perfect and efficient experimental model, all of which cannot be incorporated in any one weapon, it is then necessary to investigate the various types of automatic arms used for sporting purposes, which have been devised to fulfil the requirements for these conditions.

Some indication should first be given as to the various classes into which the different designs of automatic weapons can be grouped. The design is as dependent upon the various needs the weapon is intended to serve, as upon consideration of purely mechanical efficiency; hence we face the questions of weight, caliber and tactical usage forming a basis for the differentiation of the various types.

Since the action of the mechanism must be automatic, some source of power from within the arm is necessary for its operation. The cycle of operations must be faultlessly performed at a high speed after each round is fired. The efficiency of the arm is, to a certain extent, necessarily influenced by the quality of the ammunition. Whatever feed arrangements are designed for the method of loading, it is imperative for safety that the act of making the gun ready to fire does not place a cartridge in the chamber, as a heated gun is liable to cause a cartridge to explode.

The Rifle and Accuracy—It is only within recent times that the movements of a rifle on firing, and its effects on the line of projection of the bullet, have been thoroughly understood. Early riflemen could not trace any fall of the bullet or ball from a muzzle-loading rifle in the early part of its flight, partly because the fall was in fact small, and partly also because, when the weapon had been carefully alined on the mark, it was assumed that the bullet left the muzzle in that time; this encouraged, if it did not originate, the theory of a "point-blank" range over which no fall occurred.

The true explanation—that the whole weapon moved before the bullet left it—was long in being understood. A service Springfield rifle fired from the shoulder recoils about 0.100 inch before the bullet leaves the muzzle, the point of resistance to its movement being below the center of gravity, which has already begun to rise. The barrel is not, as is often supposed, a rigid body incapable of bending; it is very sensitive to stress. Such pressure as can be put on it by the finger will bend it perceptibly. Like any other metallic rod or tube, a rifle barrel vibrates when struck, and owing to its proportions it more closely resembles a rod than a tube in the manner in which it vibrates. It is with its vibrations as a rod rigidly fixed at one end that we are more immediately concerned. In such a case there are two types of transverse vibration which can be set up; first, a fundamental vibration, in which the whole length of the barrel vibrates as a single unit, there being only one node or point at which the barrel is still—the point at which it is fixed (the breech). Secondly, a series of overtones in which the barrel is divided longitudinally into a number of vibrating sections, each terminating in a node at the end near the breech. These two types of vibration can and usually do coexist. The frequency of the fundamental vibration depends on the proportions of the barrel, and that of each particular overtone is always in a fixed ratio to that of the fundamental.

The shock of the explosion naturally sets up these

vibrations in a forcibly arranged form, and they are effected more or less by trueness of barrel and perfect wall thickness; also by the taper and shape the barrel is turned to on the outside, by the external attachments, and by the manner in which it is stocked. The compound effect of the fundamental vibration and the overtones, and of the moment the bullet leaves the muzzle, or the inclination of the last few inches of the barrel in relation to the axis of the bore before firing, constitute the main contributory factor in the "jump" of the rifle.

It is essential that the rifle when in use should be regularly examined and repaired if its accuracy is to be maintained. The forearm, if it warps at all, is liable to put pressure on the barrel at one or more points, and may alter or limit its vibrations, and that not consistently. Bands holding the barrel and stock together will have a similar effect if they bear rather tightly on the barrel. If the screws by which the barrel and action are held should not be perfectly true, they will be subjected to unsymmetrical stresses when the gun is fired. If the lugs on each side of the bolt, or the shoulders in the body on which they bear, are not perfectly symmetrical so as to take their bearing simultaneously on firing, the small lateral movement which takes place before they can share the stress equally, will be enough to give a lateral movement to the barrel and will effect the flight of the bullet in a lateral direction. The use of a bolt belonging to another rifle may thus affect the sighting. A rifle clamped in a rigid test, as illustrated in Figure 13, Volume II, will not shoot to the same sighting as it will when held in the hands, and the effect of resting it (for example) near the muzzle, or upon the trigger guard, will, as a rule, vary the sighting.

Variations in the vibrations may arise from other causes also. As the bullet passes through the barrel, the gases behind it are exerting pressure in all directions upon the chamber and upon the bore; the entire bore is, in fact, expanded in a minute degree in rear of the bullet. Naturally, the bullet fits the bore tightly, and so far as possible makes a perfect seal, creating heavy friction during its passage. Any variation from one shot to another in the amount of this friction will affect not only the velocity, but the amount of movement which has been imparted to the rifle before the bullet has reached the muzzle. The exact point of delivery at the muzzle is a very serious factor; therefore the muzzle must be true and square with the bore. There are no marked effects on the form of muzzle selected, whether turned straight across, or formed with radii or angles, just so the bullet is truly delivered.

The actual and relative effect of these influences

will, of course, vary largely under different conditions. A heavy barrel is less affected than a light one by equal stresses. A heavy charge will set up more vibrations and general motion than a light one in the same barrel. When the velocity is low, the motion will have more time to develop before the bullet emerges, and consequently the whole disturbance may be equally great, tho less forcible and rapid.

The basis of the sighting scale is obviously the zero position of the sights when the axis of the barrel receives no elevation to allow for any fall of the bullet, but discharges it parallel to the line of aim. This parallelism is established by adjusting the rear sight where the adjustments admit, until a point on the target is struck which corresponds with the prolongations of the axis of the barrel, the center of the group of shots fired being only so much below the point aimed at as is due to the height of the tip of the front sight above the axis of the barrel and the fall by gravity in the distance traversed by the bullet.

It will be found convenient to fire at a small mark 25 or 50 yards distant, at which the fall is but small. Thus, if at 25 yards a 172-grain bullet loaded in the Model 1906 case is fired, we can state the muzzle velocity as 2440 f.s., and this figure may without material error be taken as the average velocity over this distance. The time of flight will then be, for 75 feet, $75/2440 = 0.03075$ inch, which, squared and multiplied by $\frac{1}{2}g$ ($= 16.1$) gives h as 0.0152 feet = 0.183 inches. Supposing that the tip of the front sight is 1.05 above the center of the bore, as in the Springfield rifle, then the adjustment of the sights is such that the bullet strikes 1.183 inches below the point of aim; the parallelism between the line of sight and the prolongation of the axis of the bore is complete.

It is not always possible to lower the rear sight as far as the zero point; still this does not prevent the zero from being ascertained. Therefore, in the case assumed above, if the rifle is to be fired at 25 yards with the sight set at the sighting known to be correct for 200 yards, the projectile will strike above the zero point by 52 minutes, the actual elevation for 200 yards, minus half a minute (or 1 inch at 200 yards) allowance for the height of the front sight.

The value of a minute of angle is at 100 yards 1.05 inches, and at 25 yards 0.262 inch, so that the point of impact should be at $0.262 \times 6 = 1.57$ inches above the zero point. In this way, by firing at 25 yards and using any range table, the correct adjustment of sights for any longer range can be ascertained.

It now can be understood, from what has already been said, that the prolongation of the axis of the

bore as above mentioned is not the same here as appears when the rifle is held in a vise or in the rest referred to in Figure 13, Volume II, nor will the line of sights, when correctly set to zero, be the same as compared with the direction of the center of the bore viewed centrally from the rear of the action when the bolt has been removed. The vibrations and movements, already referred to, operate to disturb the rifle before the bullet has made its exit. The amount of the discrepancy between what has been called the "constructive" zero, *i.e.*, the mechanical parallelism of the sights with the bore, and the actual zero that was found by firing, can be ascertained by careful inspection. If we set the sights to their actual zero point (or to some known higher elevation in reference to it) with the bolt removed, and use the rifle rest referred to in Figure 13, Volume II, the eye looks through the bore, and the line of the bore is accurately directed upon a mark or (better) a sheet of paper with a fine cross line, both vertical and horizontal, at 25 or 50 yards. (For accuracy the sighting gauge shown in Figure 120 should be used.) Without moving the rifle, the aim is then examined, and the point at which it is directed is marked on the paper. The angle by which this point differs from the line of prolongation of the bore (correct for height or front sight) can then be measured; this is the amount of the "jump." It may be either positive (upwards) or negative (downwards) in direction. With the Model 1906 service cartridge, it will be found to be between 4 and 5 minutes negative. With the same cartridge only loaded with the 220-grain bullet, it is about 6 minutes and positive. An obvious instance of positive jump may be seen in many revolvers, which have their front sights noticeably higher than their rear sights.

The amount of jump varies somewhat on different arms of a similar type, fired with similar ammunition. It will also be found to vary in the same arm when the amount of charge is varied or when bullets of different weights are used (such as we have in the sporting loads of the 30/06 class). Where the rifle is unsymmetrical laterally, as when it has a heavy projecting bolt head, some small amount of lateral jump will be found. A weight, such as that of a silencer attached to the barrel at the muzzle, is sure to affect the jump considerably, particularly if the barrel is worn and enlarged.

"Compensation" is a term applied to a particular effect of jump. If, from a rifle, you fire loads otherwise similar, but graduated so as to give a series of different velocities increasing or decreasing by small amounts, you will usually find that the shots are thrown successively higher or successively lower. The degree to which the change extends,

of course, is limited, and when the top or bottom of the particular phase of variation has been reached the movement is reversed, after passing through a phase in which the changes are but small. Select, then, a given rifle, and fire charges differing only in that they give successive increments or decrements of, say, 20 f.s. of velocity. Now there are inevitable variations of velocity between successive shots with precisely similar loads, no matter how carefully the ammunition may have been prepared. It is obvious that, other things being equal, the effect of plus or minus variations of velocity from the standard will be that the individual shots will have trajectories slightly less or slightly more curved than the average trajectory, and that the line of fire will accordingly be somewhat elongated vertically. If, for this reason, it should happen that the variation in jump due to the variation on velocity is of such a nature, with some particular rifle and charge developed, and when the bullets having low velocity emerge from the muzzle, they are delivered at a slightly higher angle vertically than shots of normal velocity, and similarly if the bullets having higher velocity are directed slightly lower, the changes thus occurring in the angle of departure will tend to bring together the trajectories of the different bullets, and they will in their flight intersect the normal trajectory at some distance in front of the muzzle. The effect of this will be to give, in the space at that distance, a much closer vertical concentration to the group of shots than would otherwise be possible with cartridges varying so much in velocity. In the case assumed, the irregularities of velocity are to a great extent compensated by the variations in jump; hence the term "compensation."

It will be appreciated that such a result is obtained only when the proportions of the rifle and the constituents of the cartridge cooperate in the desired direction. They may equally well have a neutral or an unfavorable influence. When the shots of higher velocity are directed above the normal and those of the lower velocity below it, the inaccuracies due to the varying velocities will be exaggerated at all distances from the muzzle forward. If, on the other hand, the bullets emerge with the vibrations at or near a neutral phase, the variations of velocity will be neither corrected nor emphasized.

It is evident that the amount of the compensation, and thus the distance at which it is most effective, will be greatest if with the charge giving standard velocity the muzzle is in the mean position between the extremes of the amplitude of its vibrations, and is, therefore, in most rapid motion. To diminish the range at which compensation occurs,

it would thus be necessary that the bullet of mean velocity should make its exit at a part of the curve in which the muzzle is approaching the end of a vibration and is in a phase of less rapid translation. It is not, therefore, usually found possible to adapt the vibrations perfectly from this point of view, since preference must be given to the wider considerations of the weight and proportions of the barrel and of the weapon generally. The condition of the bore is of the greatest importance to its accuracy of shooting. It gradually deteriorates, suffers from wear, as well as from avoidable damage.

Fouling affects the mean point of bullet impact and is a great damage to accuracy; when excessive, it often leads to a slight bulge. It appears chiefly toward the muzzle, and often accumulates in lumps that are noticeable even to the untrained eye. This can be dissolved by the chemical treatments given in Chapter XXV.

There is still much obscurity as to the factors governing the deposits of metallic fouling. In some cases it is certainly more readily deposited by some soft batches of bullets than by the harder envelopes. The main factor causing deposits is found in the minute scratches left by the barrel tools, such as the barrel reamers and rifling cutter, and these scratches are barely visible to the eye. When it once starts, the effect seems to be similar to that of a bearing which "seizes" the surface of contact, having become heated after lubrication has failed. The surface of the bullet and the bore both become extremely hot from friction.

The optical examination of the barrel to ascertain its true condition is known as viewing. The procedure is as follows: The barrel is held up to the light in such a manner that a slight shadow is thrown (as from a window bar) into its interior. In a straight barrel the edge of the shadow will show a portion of a perfect cone, and this does not alter its shape if the barrel is revolved or reversed end for end. Should such faults as bulges, bends, crooks or puckers be present, the lines of the cone are distorted. At the same time other faults, such as cuts, scratches, tool marks, pitting, fouling, wear, etc., should be looked for.

It will be understood that if a rifle is to be in condition to give fine shooting results it will need special attention in many details. Not only must the sights be kept perfectly clean, unscrubbed and undamaged, but similar attention must be given to the stock, so that the wood will not be liable to warp under the influence of weather conditions such as rain or snow. The wood should be as waterproof as possible, for which purpose linseed oil or some such preparation should be used to fill the pores; thinner oils, made for cleaning or lubricating,

cannot be used. The muzzle of the barrel should not be pinched in any form so as to check its freedom to vibrate. Screws should be watched, as they tend to work loose with firing; it is, however, a mistake to strain them by exerting too much force by tightening them. The condition of the trigger pull is of importance; it often tends to vary with use, and may easily become heavy enough to make a perfect release of the trigger difficult. It may lift a weight of about half a pound more than the maximum weight allowed, which is three pounds for the service Springfield rifle.

Factors in Rifle Shooting — Barrel—A steel tube closed at one end by the bolt. The closed end (the breech) has a chamber cut in its interior surface to receive the cartridge. The whole interior surface of the tube, from in front of the chamber to the muzzle, is cut with spiral grooves known as the rifling.

Bolt—This is a device for closing the breech of the barrel. In our modern rifles it is hollow and contains the firing pin and spring. It is fitted with means of withdrawing the fired cartridge from the chamber. It is held against the backward thrust of the explosion by lugs which form part of the material from which it is made, and which bear against surfaces on the body of the action.

Receiver—The housing for the bolt. It is attached to the rear end of the barrel by an internal screw thread.

Action—The combination of receiver and bolt, together with trigger, sear, and other mechanical parts for proper functioning of the rifle.

Extraction—Is the first backward motion, or loosening of the cartridge in the chamber, effected while disengaging lugs of the bolt by a cam effect when the travel reaches a certain distance.

Bore—Is the interior of the barrel from the front end of the chamber to the muzzle. Oftentimes used to denote the gauge or caliber. The term is mostly used for shotguns.

Caliber—The diameter of the bore measured across the lands. In American and British arms, the caliber is indicated in inches. In continental arms the caliber is indicated in millimeters.

Headspace: Rimless—The distance between the face of the bolt and the angle in the chamber at the rear of the neck when the bolt is in its closed position. Rim is the distance between the face of the bolt and the rear face of the barrel when the bolt is in its closed position.

Lead—The conical progression of the bore from in front of the chamber to the rifling; also the spiral given to rifling.

Lands—The portion of the bore left between the grooves of the rifling.

Free Travel—The distance the bullet has to pass when it leaves the cartridge case before it engages with the rifling.

Clip—A holder which contains a number of cartridges, usually five, for the magazine of a rifle.

Weight of Projectiles—In ballistic calculations the weight of the projectile is always taken in pounds avoirdupois (7000 grains = 1 lb.), but in tables of weights of rifle projectiles the weight is usually given in grains. For instance, the weight of the bullet for the Service Model 1906 cartridge is 150 grains and is always so stated.

Sights—The human eye, like the photographic camera, which is exactly similar in principle, is unable to focus simultaneously objects at various distances from it. From this it follows that in alining two or more objects, such as the open sight on a rifle with the targets, only one of them can, at any given movement, appear perfectly defined. In tracing the design of rifle sights from the simpler to the more complicated it will be found, however, that the attention of inventors has been directed, first, toward bringing all objects which have to be seen into as nearly the same focus as possible, and secondly, toward magnifying the image or target so as to make it more readily visible and increase the accuracy of aim.

Optical Sights—Various devices have been invented from time to time with the object of providing, by means of lenses or mirrors, simultaneous focusing of both the front sight or aiming point and the object or target without magnification of the latter. All have certain defects, and only practical principles of design shall be discussed.

The Galilean telescope was the first principle of design used and embodies the leading construction on which all low-power field glasses are made. It magnifies the image or the target, but does not give perfect definition of both object and aiming point. The convex lens, which must be of greater focal length than the sight radius, is attached to the tube at the front or near the muzzle of the rifle. The aiming point is attached or ground into the front surface of this lens. The effect of such a convex lens is to make the rays of light from the object converge. The rear sight consists essentially of a very small aperture, which in fact has a concave lens to render the rays from the target or object again approximately parallel.

For those who wish to experiment in this field, a descriptive illustration is best. To enable the eye

to see the object clearly the concave lens at the rear should have a focal length equal to the difference between the focal length of the front lens and the sight radius; on the contrary, the aiming point should be seen very clearly with a convex rear lens of focal length equal to the sight radius. It is evident, however, that there must be a distinct amount of blurring of either the aiming point or the object. The exact amount of blurring that actually occurs is, therefore, greatly reduced by the small size of the rear aperture, which can be used to great advantage. The correct diameter is about 0.04 inch. The actual rear lens used in practise depends on the desire to give better definition of the object or to the point of aim. The target is selected in order that it may not readily become invisible in bad light, and a concave rear lens of slightly longer focal length than that which the figures require to define the object, is used. When it is decided to define the aiming point, it may be that no lens at all will be required in the rear. The perfect definition of the target cannot be obtained if the aiming point is to be reasonably visible, and *vice versa*.

The field of view of such a sight is very limited. It may be calculated by finding the angle subtended at the rear sight by the front lens and dividing this by the magnification. The accidental rotation of the front lens must be carefully guarded against, as it usually introduces a serious error when it occurs. Rotation of the rear lens, to be sure, whenever it is situated behind the aperture, has no effect on the line of sight.

The line of sight radius is the most important because, for any given magnification, the lack of definition is inversely proportional to the sight radius. Thus much more blurring will occur when a sight is only given a 30-inch sight radius than if it were possible to give it a 45-inch radius.

The construction of the rear sight is exactly the same as that of the aperture sight already described, except that provision must be made for a method of holding the rear lens back of the aperture. The sight, consequently, is easy to fix very rigidly, a marked advantage as compared with the terrestrial telescope about to be described.

The Standard Telescope Sight—The essential design of this sight is that of the ordinary astronomical telescope. A convex lens or objective, as it is called, of shorter focal length than the sight radius, is employed. The parallel rays from the object pass through this, and form an inverted positive image at its focus. There is situated the aiming point, which consists of a pointed post, fine cross lines (known as "cross hairs"), or various other shapes and forms of pickets. The inverted

image of the target or object is viewed through the erecting lens and eyepiece. In place of the erecting lens a prism has been used, after the design of the ordinary prism binocular. This method is not usually so satisfactory in the construction of a rifle telescopic sight. Due to the fact that the aiming point and the inverted real image of the object lie in the same focal plane, it follows that each appears perfectly defined when viewed by the eye. This is the only sight in use at the present time with which all objects which must be seen while aiming are perfectly defined.

When designing such a sight almost any desired amount of magnification can be obtained. The illumination with a good sight of low power is such that very accurate shooting can be continued in a very bad light. There is one possible exception—when the object cannot be shaded—when shooting toward the sun from a position in bright sunlight at an object in deep shade. In such exceptional cases the use of open sights will be found more satisfactory. In order to keep the telescope from contact with the face when recoil takes place, the focus for the eye is situated at about 3½ inches from the rear line or eyepiece. This gives another advantage to a sight of this nature: it affords a certain amount of lateral relief for the eye. Accidental rotation of the telescope in its mountings—or of the objective lens, or of the cross hairs—usually produces serious errors for optical reasons. It can be clearly understood that "canting" the rifle when aiming cannot cause any error of this kind, but just the ordinary error of "cant"; because, by the act of aiming, the telescope must be rotated with the line of sight as the axis of rotation.

Telescopic sights are completely inclosed in tubes, which are of various lengths according to the designs of the makers. Telescopes the full length of the barrel were used at one time; they were abandoned on account of the distortion in such a tube and its inability to withstand recoil. The telescopic sight is mounted in various designed bases rigidly attached to rifle barrels as well as to the action. Different dovetail arrangements are usually introduced in order to permit the sight to be readily attached and detached. Adjustments are provided for elevation or depression by moving the cross hairs or posts up and down by means of an elevating screw which has a scale inscribed on a turret on the top, or with a rear mount to act for windage and elevation as designed by Lyman and Fecker. Windage adjustments are now provided for in the objective lens, and also by pivoting arrangements of the base.

In modern methods of holding a telescope rigid in its mounting, there is a limited amount of recoil

it can stand, without designing the telescope more rigidly to take the heavy recoil of modern ammunition. Mounts have advanced further than telescopes in their construction, and the manufacturers of telescopic sights should not only make the telescopes but the bases as well in proportion to the caliber of the rifle it is to be used on. Whenever the least bit of lost motion occurs in the mountings, a hammering action is set up by the recoil, which upsets the adjustments and at times loosens the lens and parts in the telescope.

One method of using a .22-caliber telescopic sight for a high-power rifle is to adopt a mounting similar in design to the Lyman, Parker, and Fecker, which consists in avoiding the shock of the discharge by simply allowing the telescope to slide forward in its mountings when the rifle is fired. Such sights as the Lyman, Parker, and Fecker are capable of very fine accuracy, but they still require the utmost care to produce the best results on high-power rifles. Sights must be reset by hand after each shot, and are quite useless for rapid fire.

It is apparent from the above that the main defect of the telescopic sight is the difficulty of keeping it rigid in its mountings. This is particularly important because of the shortness of the sporting type of sight base, so that the effect of any lack of rigidity is greatly magnified by comparison with that occurring with different types of sights. The telescopes themselves are usually so much better made than they were formerly, that they do not often give trouble when the correct mountings are selected. Another objection to a long telescopic sight is that it does not in any way follow the curve of a barrel which has become hot as the result of fast firing, particularly when attached to a caliber .30 Springfield. How much importance there may be to this is a matter of experiments with a properly constructed machine rest.

There can be no doubt that this sight when correctly designed is comparably the best when extreme accuracy is required for objects which are rather difficult to see with the naked eye, but it must be treated as a rather delicate instrument reserved for a special purpose and should have a well constructed case designed for its carrying when not in use.

Small Arms Cartridge Cases—The manufacture of small-arms ammunition has become a very highly specialized industry. The various processes employed are a multitude of precision operations, and a complete understanding of them involves a scientific knowledge of mechanics, physics, chemistry, and metallurgy. I have made no effort to cover the entire field of various designs

for sporting and military cartridges. Their construction requires special technical knowledge rarely found in books written in the form of a treatise on the subject. I have been away from the arsenal for a number of years, and many points may be lacking; still, with that foundation there is at least a working knowledge. The interested person seeking actual experience in the making of cartridge cases, primers, and bullets, will find it necessary to visit various cartridge-manufacturing plants to get the necessary enlightenment on the methods used in their fabrication.

Apart from requirements for technical and scientific knowledge, the best cartridges require extreme precision in their development, and as the cost of manufacture is a matter of great importance, this regularity of manufacture can only be obtained by a mass-production layout. The science of cartridge manufacture at the Frankford Arsenal, over a period of years, has evolved special machines for each operation, most of which are automatic. New designs have been made and tried from time to time until low-priced mass production of superior products is possible. When ammunition is turned out in large quantities it should be done in a modern factory, suitably laid out and equipped with special modern automatic machinery, each performance of which is special to the operation it must perform. The necessity for exact interchangeability of its components is guaranteed by a select organization governing the sequence of operations, by the support of all tools and machinery, by a separate organization maintaining them in a high state of efficiency, and by the strict elimination of defective materials.

It is very clear that the making of small-arms ammunition is a serious undertaking, and any attempt to increase capacity very rapidly must be accompanied by considerable waste and also risk. It is essential that there should be maintained, in time of peace, sufficient manufacturing of new ammunition for trial purposes in the field, and to overcome vital difficulties of manufacture. An organization possessing a practical knowledge of the manufacture of cartridges should be held available for any emergency. These unusual considerations ruling cartridge manufacture have been brought forward in the manner best suited, simply because the capacity of any nation to manufacture small-arms cartridges in sufficient quantities during the time of war is so very important. Very few nations are capable of maintaining these organizations, and besides it is quite impracticable during peace time; but if enough men would train themselves to do this class of work in their own experimental shops, as taught in these volumes, we would be a nation capable of rising to such an emergency when

the call came to man the well-equipped plants.

The different types of military cartridges differ considerably in design, and a complete description of the various methods of manufacture for every nation would occupy many volumes and require a lifetime of study. American factories use very different manufacturing methods, depending on their own experience and the local facilities. The various methods may not differ greatly, and it is impossible to give a full description of all the separate details of operations. So far as the aspect of the question mentioned above is concerned, this country is mostly interested in the manufacture of the caliber .30 Model 1906 ammunition and the new cartridges for automatic arms; it is therefore proposed to bring out the designs of some of the caliber .50 machine-gun ammunition now standardized for aircraft service. The first consideration will be the Model 1906 cartridge, dealing with the scientific problems involved at the Frankford Arsenal, as well as confining the description of the processes employed, with various recommendations for the economical production of ammunition in cases of emergency.

The caliber .30, M. I. (present service bullet) of 172 grains, and boat-tailed, is standard for the United States Army. The point of the bullet has been given a special ogive, and if laid out on paper on a scale 10 to 1, a radius could be found near a certain number of calibers. At a given distance from the base is a cannelure, for the purpose of crimping in the end of the case. The bullet is held in the case by friction as well as a special waterproof material being coated on the inside of the case. Between the waterproof material, crimp, and friction, the bullet must undergo a pulling test between 150 and 250 pounds.

The case is of solid drawn brass, and has a rimless head at the base end by which the cartridge is drawn from the magazine and positioned in the chamber and extracted. The primer pocket is recessed in the back of the case with a center flash hole.

The primer, which is made of brass, is pressed into the pocket, crimped, and waterproofed in the joint between the primer and case. The primer has a separate anvil, and this is pressed in place after the composition. The primer composition is pressed in first, and a disc of shellacked or varnished paper pressed over it. Then the anvil is pressed in position.

There is for this cartridge an improved military powder which has a nitrocellulose base and is known as a "progressive" type; that is to say, it is impregnated to a certain depth with a deterrent which has the effect of slowing the rate of burning during

the early stages of combustion. Since there are so many types as well as weights of bullets used for sporting purposes with the caliber .30 Model 1906 case, various types of powders are employed to secure the best ballistic qualities.

Factory Layout—The manufacture of small-arms ammunition is divided into three sets of operations. The first operation takes place in the cartridge-case shop, where the cases are drawn, headed, annealed, tapered, etc. The second operation embraces the bullet from the draw to the final assembly. The third operation includes loading as well as primer assembling. There should be a fourth department in the larger plants, and the fourth operation would consist of rolling the sheet brass and bullet metal, using either cupro-nickel or gilding metal; but since the brass plants are so well equipped for such a purpose, it would be more economical to have such plants manufacture the cup rather than pay freight on the waste or scrap. All these operations take place in separate buildings, but under the supervision of one general planning room.

The layout for the cartridge-case division should be such that the movement of the finished operation, backward and forward, is reduced to a minimum. Machines used for slow, tedious operations requiring several machines, should naturally all be alike, due to the simplicity in the making of tools as well as the extra parts needed to keep the machines running continuously. They should be placed in locations which facilitate supervision, and to some extent prevent mixing with other cases in different stages of the operations.

A considerable amount of annealing and pickling takes place in connection with the case-drawing operation, and the heat and fumes from the annealing furnaces cannot be avoided. The pickling processes involve the use of acids; therefore it would be desirable to arrange these operations in a separate wing of the factory, but still accessible to the draw presses. A cartridge case must be annealed several times, as well as washed and water-polished several times throughout the operation. The annealing division should be accessible to the factory, and the various machines for the operations which immediately precede or follow an annealing process should be located near the annealing room, as well as the washing and water-polishing operations.

In the case of small-arms manufacture of ammunition, regularity of operations can only be obtained by very accurate tools made in a well-organized tool room. All tools should be strictly interchangeable. Gauges are made to keep the tools up to the standards expected of their performance, as is always the

case in a highly specialized factory of this nature. To turn out tools in very large quantities, the making of them is performed by a highly skilled body of tool makers and specialists, the latter men to be trained for one particular operation in the production of tools. The latest and best of machinery should be installed in the tool room and always kept in the best condition.

The various components are made to small tolerances and are placed in operation many times. Small-arms gauges wear out very rapidly, and for this reason special gauge makers should only perform this work in the tool room. One man should be responsible for collecting the gauges from the different operations each week and leave new gauges in their places. Therefore it is found necessary to provide a number of extra sets, as well as masters for checking returned gauges.

The work in the loading room is done in specially-built machines which place the exact weight of powder charge, insert the bullet to the correct length of gauge, and also crimp the end of the case into the cannelure. Suitable clothing should be

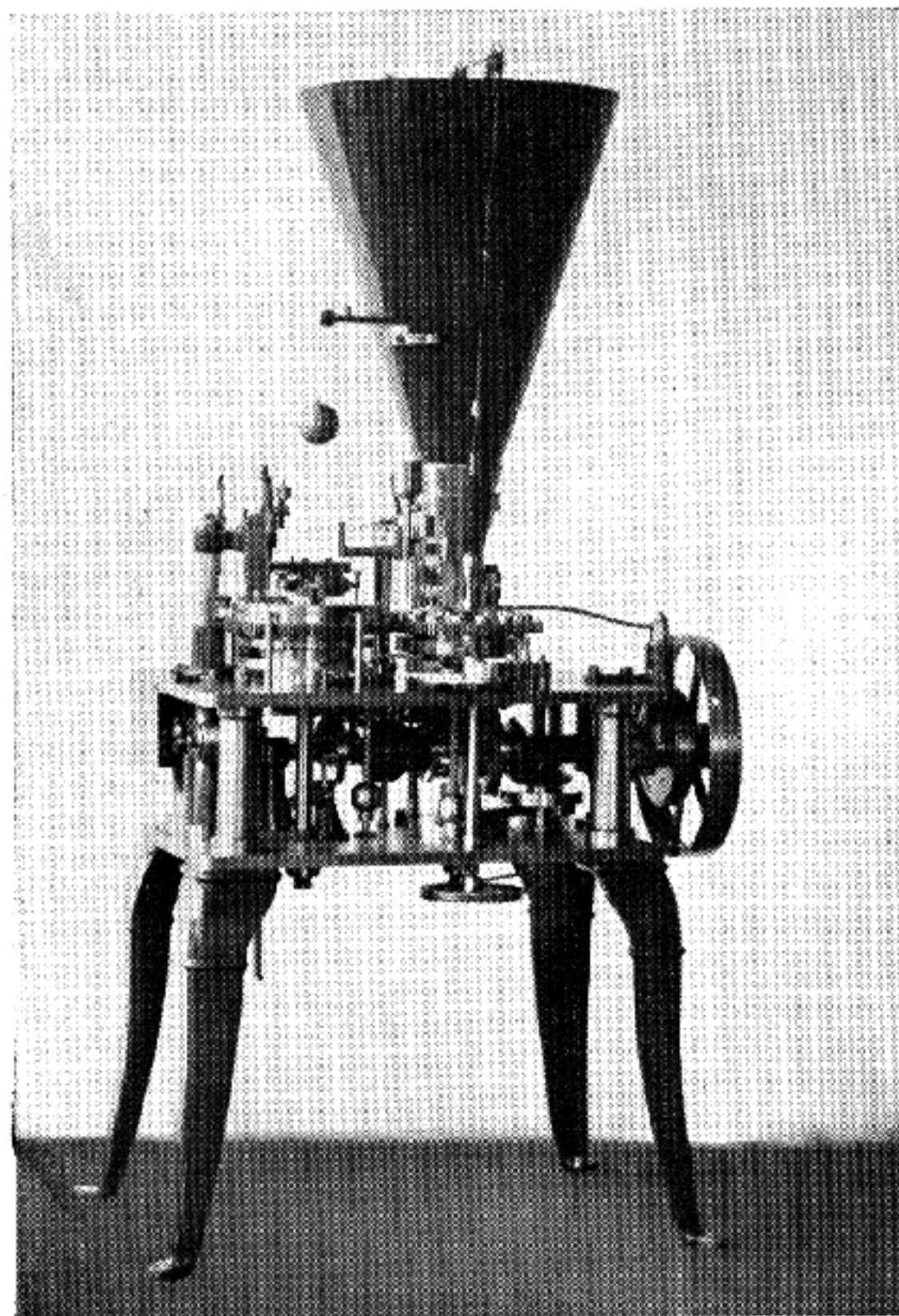

Fig. 155

Cartridge loading machine. This machine gauges the powder charge, inserts the bullet, and crimps the end of the case in the bullet cannelure

worn by all employees, including rubber shoes. The possession of matches or other means of striking fire should never be allowed inside such a room. Knives or any other steel implements that can be carried in a pocket should be forbidden. This department should be disciplined with special rules and known as the *Danger Building*. These rules should also govern the primer assembly operations. Some means must be provided for controlling the hygroscopic conditions of a loading room to suit the powder being loaded. A proof house as well as a rifle range is required within easy reach of the loading room, equipped for taking velocities and pressures for the correct development of charge when loading.

Cupping — The two most important considerations in any cartridge case are, first, the brass should be of the best quality, and second, after the completed operations the various parts of the case should have a certain degree of hardness.

The double-action presses are made powerful and carry five punches in which discs are first cut out of the sheet-brass strip, and the inside punches form these into cups. Figure 156 illustrates a press on which this operation is performed. As the punch descends over the metal strip it cuts out a disc. In the center of the blanking punch a separate punch descends, which forms the cup out of the blanked disc, and is then stripped from the punch against the sharp edge on the bottom of the die.

Should the sheet brass be heavier or harder on one side than on the other, there is the possibility of the cup being thicker on one side than on the other. This is very objectionable, as such a fault continues on through all the various operations and appears in the finished case. The waste on the brass strip is cut to a minimum. The position of the dies is so arranged in the die plate that staggered blanks are made possible. This necessitates the use of a double-action press, and the strip fed forward by feed rolls is in a straight line. The scrap as it emerges from the opposite end is cut or sheared for convenience of handling. Usually five sets of tools are used, and make five cups on each stroke of the press. The blanks, however, are not punched on the center line of the strip. For these reasons it is essential that the strip must be of even thickness; it is particularly important that it should be the same thickness on both sides as it is in the center and at the same time perfectly annealed the full length of the roll.

After the cups are made they must be annealed. In this and the following draws which take place, the cases consist of a great number of small pieces,

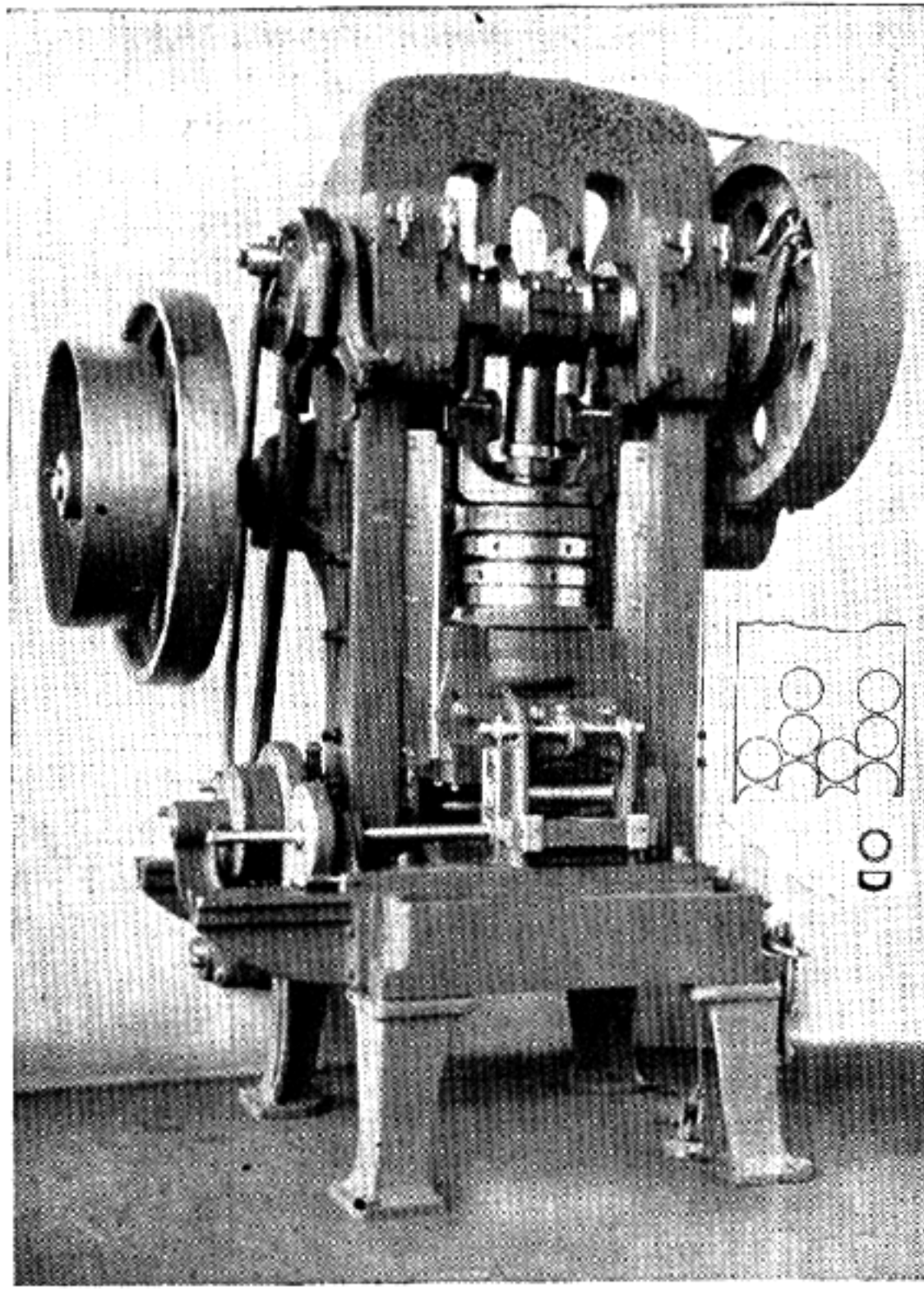

Fig. 156

Double-action press, capable of producing 20,000 cartridge cups per hour

and the annealing furnaces usually take the form of cylindrical drums with a slow revolving cast-iron worm which passes the pieces through in a given time, the furnaces being maintained at a fixed temperature, generally between 1100 and 1150 degrees Fahrenheit. After annealing, the cups are "pickled" or cleaned by immersion in diluted sulfuric acid, rinsed in water by being placed in circular wooden rumbling barrels, allowing a stream of water to play upon them as the drum revolves. They are then placed in trucks and brought to the first draw press, known as the first drawing operation.

The sequence of operations is as follows:

Operation Number

1. Blanking and cupping
2. First anneal
3. Pickle
4. Water polish
5. First draw
6. Second anneal
7. Pickle
8. Water polish
9. Second draw
10. Third anneal
11. Pickle
12. Water polish
13. Third draw
14. Bumping

15. Fourth anneal
16. Pickle
17. Water polish
18. Fourth draw
19. Fifth draw
20. First wash and dry
21. First trim
22. Pocketing
23. Heading
24. Vent punching and pocket sizing
25. Head turning
26. Second wash and dry
27. Body anneal
28. Tapering and plugging
29. Third wash and dry
30. Second end-trim
31. Point anneal
32. Wash and water polish
33. Case inspection
34. Primer inserting, also varnishing primer and mouth

First Draw — The cups now pass to the first drawing operation to be drawn gradually into longer tubes. This operation of "drawing" consists of passing the cups through two draw dies and a punch so made that the correct percentage of reduction in the brass will be drawn out for the following operation. The punch is made smaller than the internal diameter of the cup, so that some of the metal in the base of the cup is transferred to the walls. The dies are also made smaller in diameter than the cup, and the difference in diameter between the punch and the dies is such that it

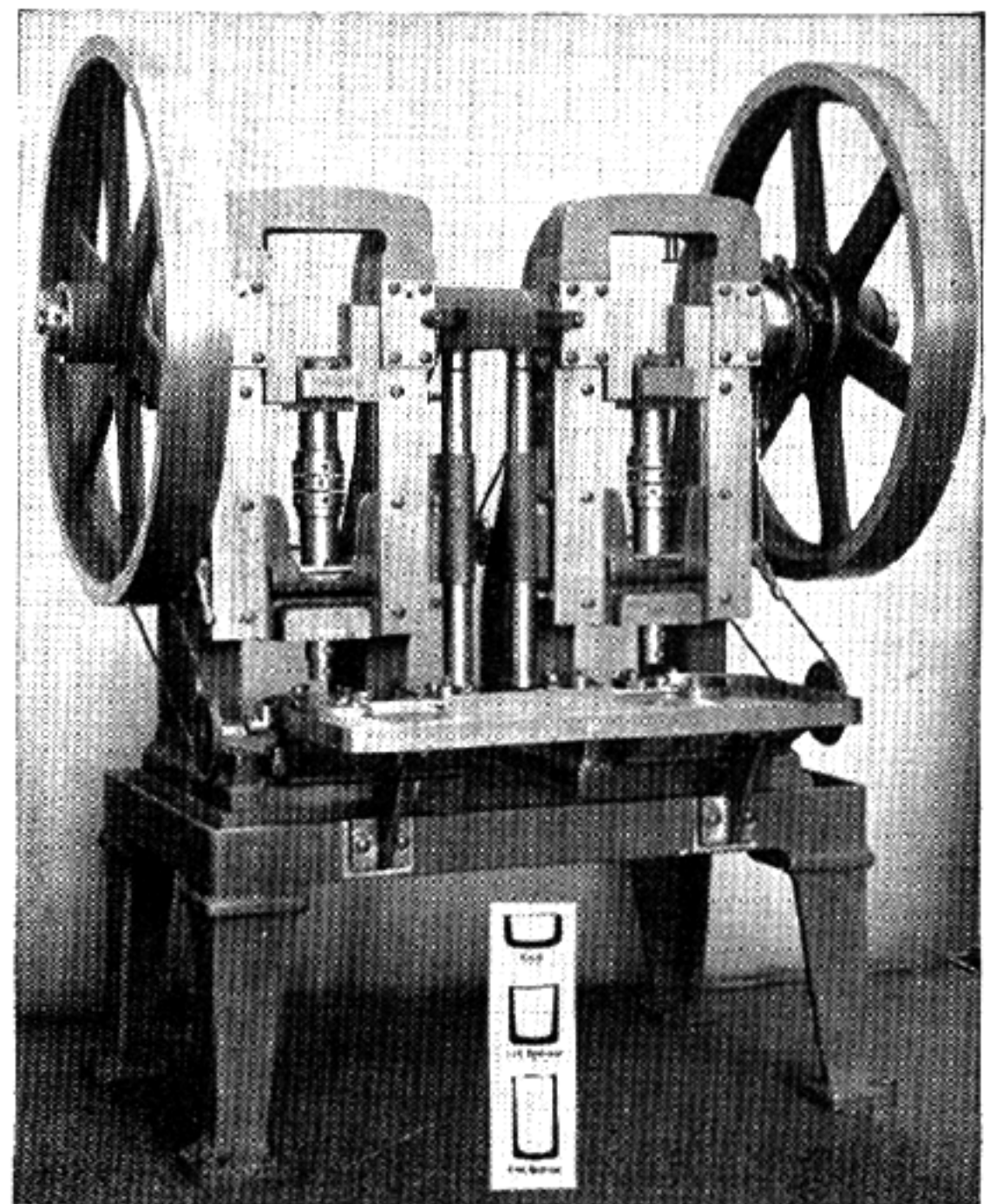

Fig. 157

First and second operation draw press, friction dial feed, for rifle-cartridge cases

lengthens them and also thins the walls. This draw press is illustrated in Figure 157. The cups are placed upon a revolving feed plate. The press also carries two punches. A separating piece of metal is so arranged that they are always in their correct positions to be fed over the dies when the punches descend. The punch then descends and passes them through the die, from which they emerge in the correct length. Second, third, fourth, and fifth drawing operations are performed in a similar manner, but with a different design of feed mechanism.

The amount of drawing or the percentage of reduction which can be done in each operation is dependent on the extent to which the brass can be distorted without hardening the metal. A cartridge case is usually drawn five times, except in cases of smaller shells. After each draw, except before the last, the cases are annealed and pickled in a diluted sulfuric acid bath to remove the scale, and then water-polished.

Bumping — Between the third and fourth drawing operations is the "bumping" process, which flattens and slightly concaves the base of the case. Advantage is taken of the opportunity at this point to reduce the very large radius or crown at the base, so that the metal at that point can be flattened both on the inside and outside, while the case is in an annealed state. This operation consists in pressing the base of the case between two punches. A die acts as a means of holding the outside size to a given diameter. This operation is more or less important, since the operations that follow require a flat surface to work from; and at the same time it allows a given wall thickness, which is easier to retain in the twenty-second and twenty-third operations. Improvements can be made in this operation, such as placing a modified pocketing process to relieve some of the work in the twenty-second operation. A machine is used similar to that shown in Figure 159.

When an anvil is made integral with the case the outer punch is so shaped as to impress into the metal recess an imprint of the anvil so that the following heading operation will be able to bring this up to the desired form. When a case is made with the anvil in a primer pocket it is very important that no lubrication is used as in the regular bumping operation; it should be kept free of grease or liquid on the case or the indenting punch during the operation, as any lubricating liquid trapped in the closed recess of the punch will act hydrostatically and prevent the anvil from forming in the base of the chamber. For this reason, after the third draw the cases are washed in a soda-water

solution and dried in hot air. The only lubrication used is a cloth saturated in lard oil, which the operator wipes over the cases as he feeds them into the machine.

Fourth Draw — The fourth draw operation follows. Annealing takes place before the cases are fed to the machines, and as this draw has a noticeable effect on the length of case it is realized that the edges of the walls become rather uneven and ragged. The fifth draw is arranged to make the cases longer than required. After the fourth draw operation the cases are not annealed but are fed to the fifth draw press after they pass through the fourth draw dies. Figure 158 illustrates the type of press used.

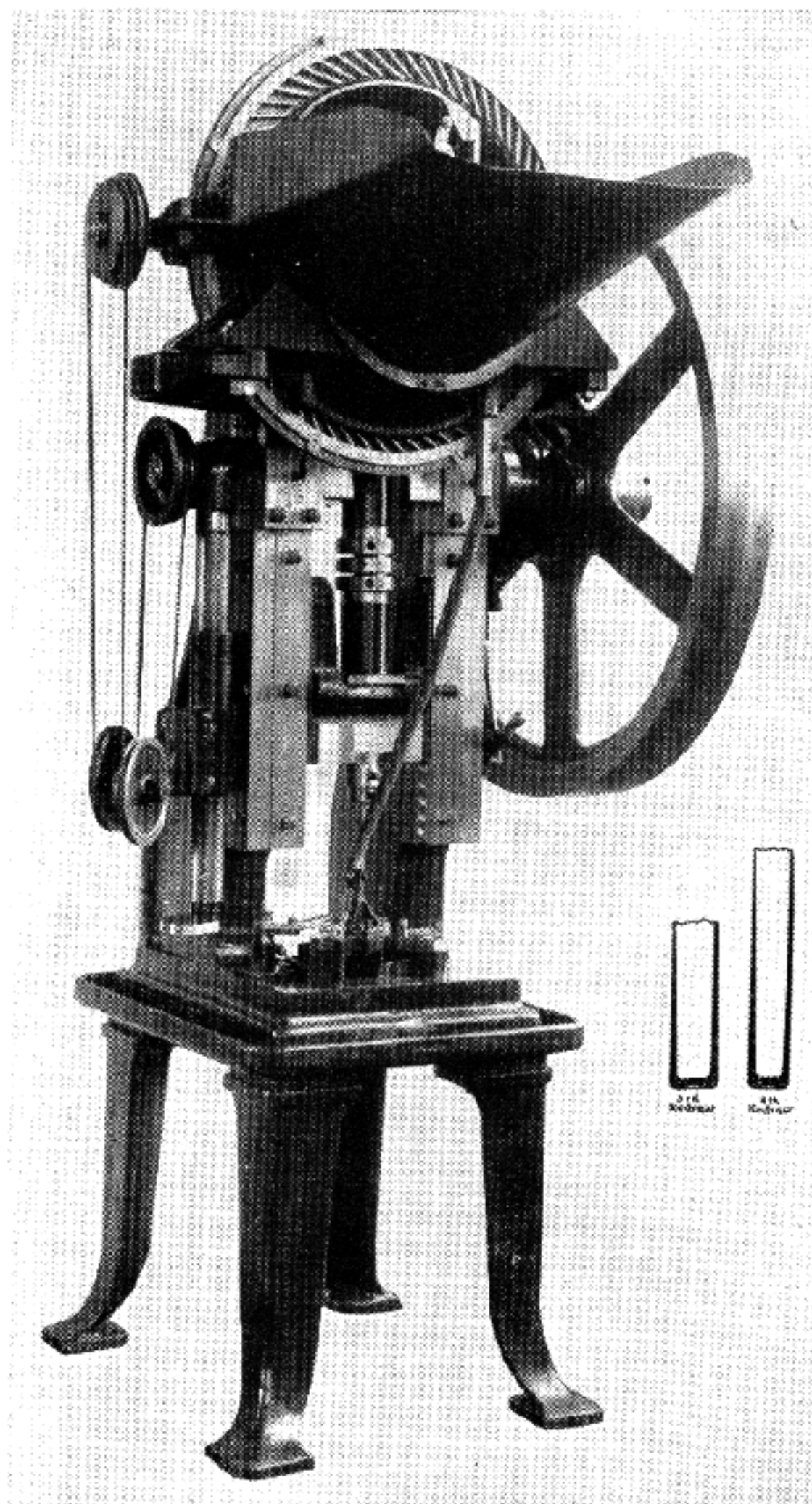

Fig. 158
Hopper-feed cartridge case draw press. This machine produces the fourth and fifth drawing operation on the cartridge case

Fifth Draw — The fifth draw is the most important of the drawing operations, and great care must be given the draw punches and dies. They must be changed very often in order to keep the desired standard of the cartridge case when completed. The thickness of metal at the point where the neck of the case is formed must be held to a given tolerance. When new punches and dies are placed in the press, minimum thickness should be produced; then the punch and dies are allowed to wear to the maximum thickness. The greatest amount of tolerance that can be given is only 0.0015 inch, due to the fact that any bottle-necked cartridge case thickens between 0.003 and 0.004 inch in the twenty-eighth or tapering operation. When a case is manufactured that has an uneven thickness of metal, this is the operation in which it appears very pronounced.

Among the gauges to be provided are a ring gauge and a gauge for metal thickness. A length gauge should not only be provided at each machine during the drawing operation, but should be used to determine the correct length of case being drawn for the first trim. Rather a confusing situation exists if the fifth draw is only gauged with a ring gauge; working the base of the case through a ring gauge gives a false reading; the solid metal in the head creates a difference of 0.001 inch between the base and where the metal begins to taper off, forming the wall thickness of the case; therefore a dial metal thickness gauge must also be used as frequently as the ring gauge for a check.

First Trim — After this operation the cases are washed in a soda solution, passed through boiling water, dried, and then given the first trim to a definite length on an automatic machine. The case is fed on a revolving spindle in which two sliding

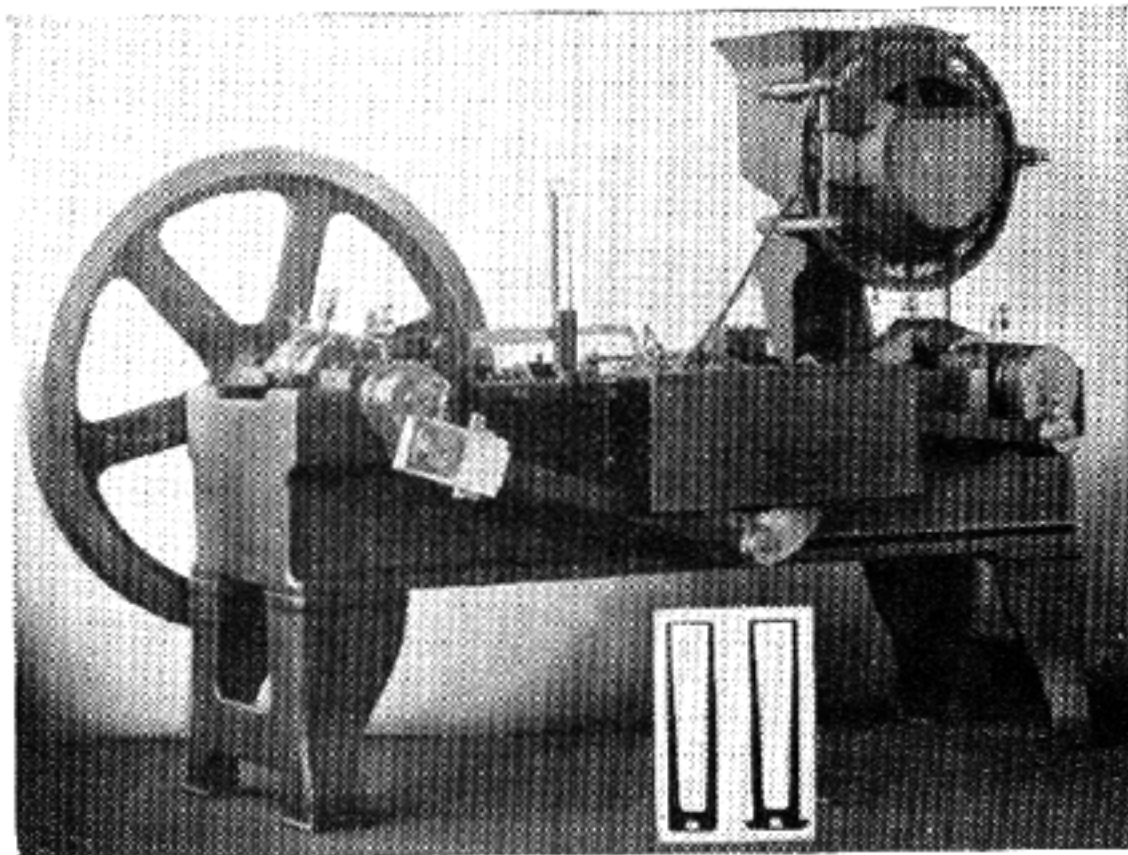

Fig. 159
Cartridge-case pocketing and heading machine

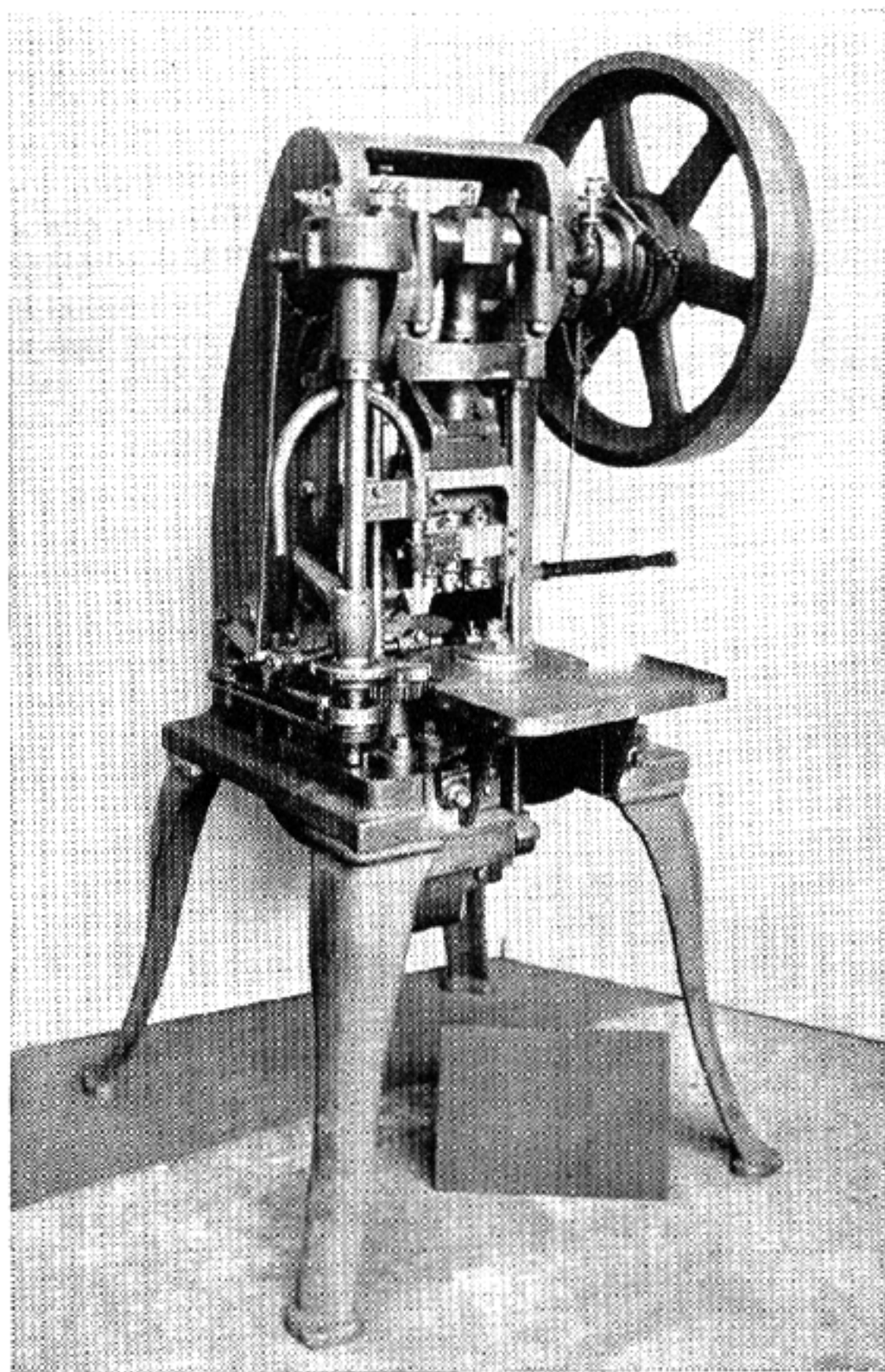

Fig. 160
Cartridge-case, vent-punching and pocket-resizing machine

rings are held together by a spring. On the back of the machine a circular revolving cutter is moved into the cutting position by means of cams. After the case is trimmed, a device removes the scrap before another case is fed upon the spindle. Advantage is taken of the softness of the head to carry out the pocketing and heading operations.

Pocketing and Heading — As the trimming operation precedes the pocketing operation, this process embraces all the work of heading the case. In both instances the shell is supported inside a die, set in a heavy steel die holder, the punch passing inside the case. The head is formed by the punch which presses the metal of the head on the face of the die. The travel of the two punches is accurately adjusted so that the metal thickness is left exactly the correct web tolerance where the vent hole is punched. The heading punch is left a trifle smaller in diameter, and this is resized in operation twenty-four. The heading punch is marked with reversed letters and numbers showing place of

manufacture as well as date—month and year. The machine used is shown in Figure 159.

Vent Punching — Piercing of the vent hole is the next operation, as well as resizing the primer pocket. The machine (Figure 160) which performs this operation has a circular revolving plate in which a series of dies are held. The fire-hole piercing punch performs the first operation, followed in resizing of the primer pocket. Next is an indicator for the purpose of tripping the machine in case a hole is not pierced due to a broken punch.

After the fifth draw and the closely related pocketing and heading operations, the amount of work to be done on the base end of the case is very small. If the cases were annealed at this stage they would undoubtedly remain too soft, and the results in the firing test would be enlarged primer pockets and swollen heads. There is, however, no annealing done at the base end of the case after the fifteenth operation. The amount of work performed after the bumping operation must be carefully adjusted so that further work at the base end of the case just brings the brass up to the desired degree of hardness. The metal should be much softer at the front end of the case, as there is still a great amount of forming to be accomplished, partly for the reason that the finished case is of a tapered form, and the diameter at the front end still has a greater reduction from the shoulder.

Head Turning — The cases are now head-turned to the correct diameter in an automatic head-turning machine. The cases are held in a spring collet or chuck. The exact amount of holding pressure is applied, and the heads turned with an under-shot form tool, similar to the way a shaving tool is worked on an automatic screw machine. The feeding arrangement is unique. As the cases are fed down a slide from the hoppers, a swinging section of the end of the feed mechanism comes into posi-

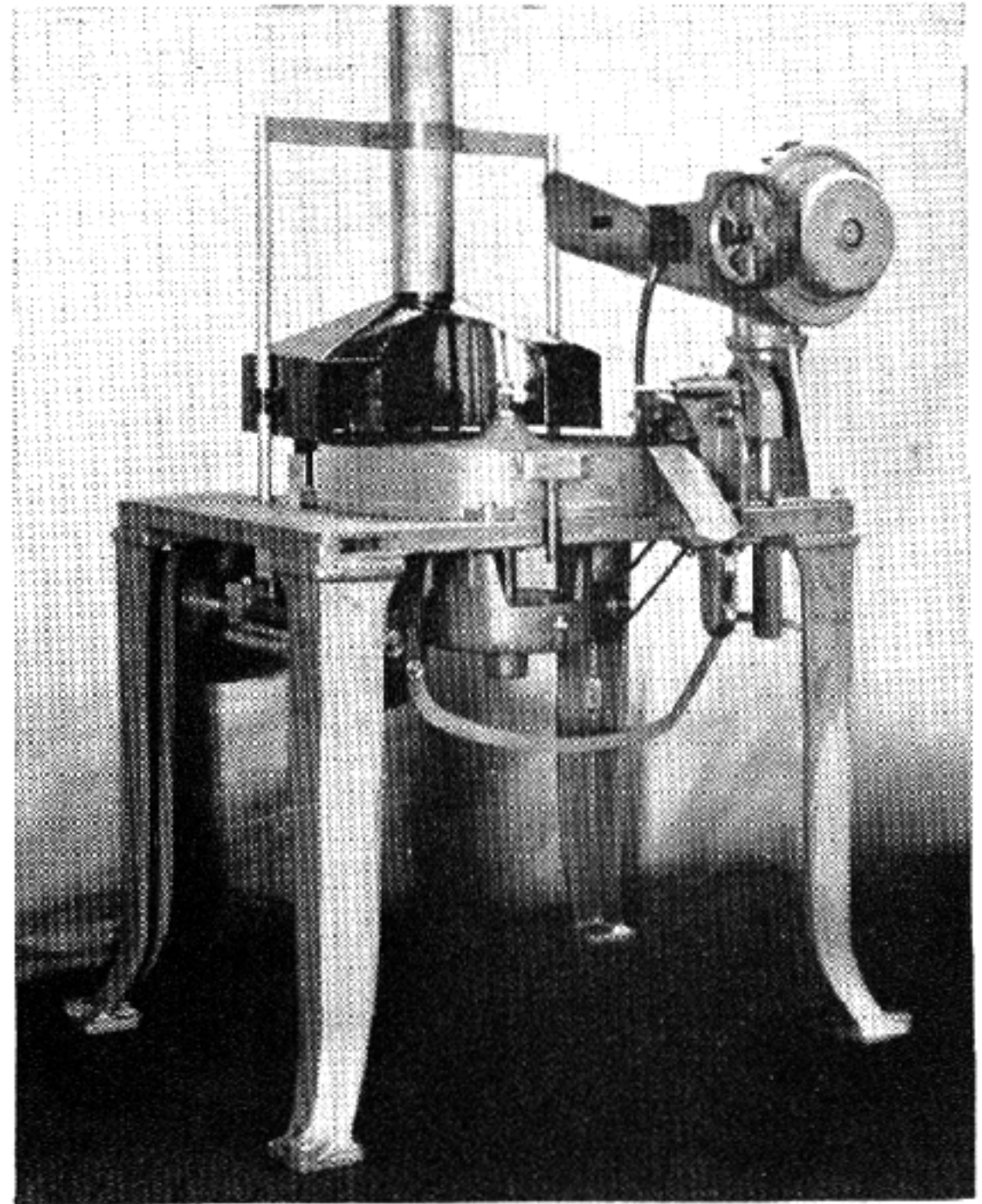

Fig. 162
Cartridge-case annealing machine

tion in the center of the collet. A rod then comes forward, pushing the case to the exact depth in the chuck. The mechanism is so timed that the rod returns very suddenly. The tool post moves forward as the tool begins to cut against the shoulder on the head of the case, to turn it to the exact form and gauge size. After the head is turned the tool post is returned in the clearance, the chuck opens, and the case is ejected with a spring kicker to fall into a truck placed under the machine. The brass turnings or scrap goes down another opening or chute into a separate truck. Figure 161 illustrates this machine.

Body Anneal — The cases are now washed and dried and given the body anneal. The machine is shown in Figure 162. This is done by passing them through a series of gas jets on a circular revolving table, the heads emerged in water so that the temper of the heads will not be endangered during the operation. The depth of water will govern the position of temper on the body of the case. A more detailed account will be given later on this subject.

Tapering — After the body annealing process the cases are tapered. This is done with two dies set in a holder. The tapering is carried out in two

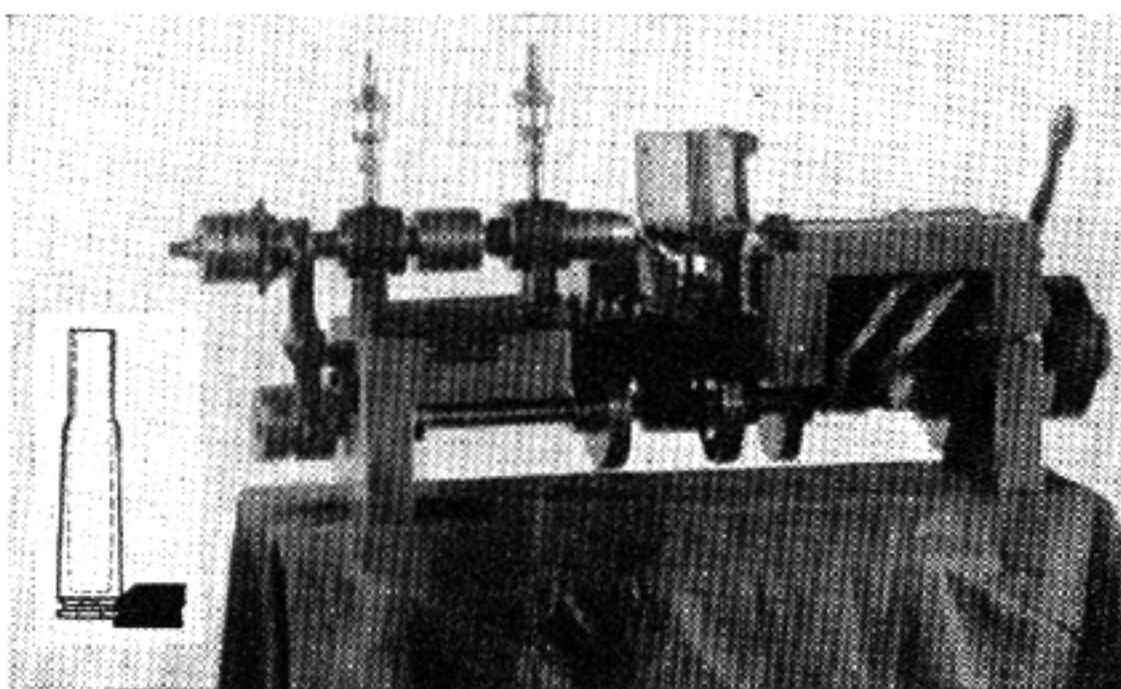

Fig. 161
Cartridge-case head-turning machine

operations on the same machine, the first being a roughing or breaking-down operation, while the second finishes the case to the exact size and to the exact length from the shoulder to the base. A plugging or inside resizing operation is performed on the neck of the case to give the bullet the proper amount of friction to hold it in position during the loading operation. The tapering machine is made with a circular revolving plate, as shown in Figure 163. Separate inserted plates are set into the re-

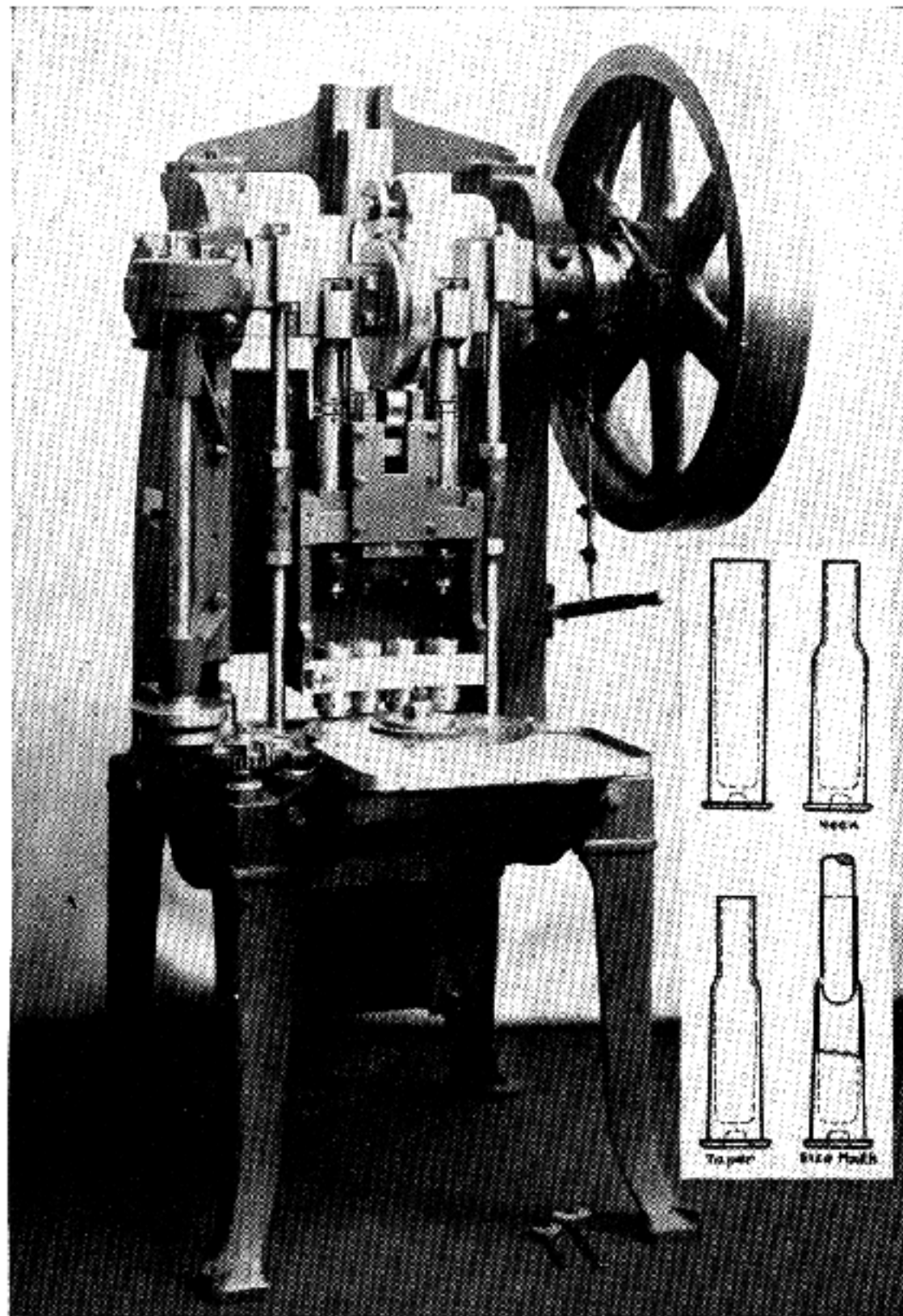

Fig. 163

Cartridge-case tapering machine. This machine tapers the body of the case and sizes the inside of the mouth

volving plate to hold the cannellured head. A circular feed plate feeds the shells against a device which locates the cases in the revolving plate, and then brings them under the operation of the dies. This press has two cams located on each side of the crank, which are for the purpose of holding the cases down by rods resting against the bottom. The effect of the cams allows the cases to be held on the plate long enough so that the dies are released. Considerable pressure is required to release the dies off the body of the case after the tapering takes place, and the only practical manner is to

have these rods bearing against the bottom web with sufficient pressure so that the dies will be released without any effort upon the descending stroke.

Second End Trim — The cases are now given the second end trim. This operation trims the case to the exact length and the mouth of the case on the inside is chamfered. The machine is automatic throughout its operation. As the cases come down the feed tube they are set in an upright position and moved under the fast revolving head which carries small high speed cutters. This descends very slowly and while in the cutting position fine chips are turned directly off the face at the end. The small chamfering tool follows it down and when the full length of travel is reached the head travels up, at the same time ejecting the finished case, and a new one is carried into position.

Point Anneal — The point annealing process now takes place. This operation is performed on a machine similar to the one shown in Figure 162 for the body anneal, except that the extreme end of the case passes through a series of fine flames from small gas jets, and the neck is annealed up to the shoulder. The distance from the mouth to which the end is annealed is important, and is controlled by the adjustment of the length of flames.

Inspection — After the second end trim the cases are washed and given a water polish. The shells are now completed and are sent to the inspection department, where they are viewed to eliminate those containing any defects by careful visual examination on a special automatic machine. The cases are fed along a worm, and a mirror is set at an angle in the back; a mirror is also placed in front of the worm in such a position that it is possible to view the base and primer pocket to detect the absence of flash holes or the closing of flash holes by burrs on the inside. A powerful electric light is set in such a position that the case looms up very clearly in the mirrors.

Primer Inserting — Primer inserting and the varnishing process follows, which is also performed on an automatic machine. This machine is unique in design; the cases are fed into dies in a large circular plate; the primers are fed over the cases by a small revolving friction plate setting the primers in place. It makes a given turn so that the primer-inserting punch comes down and seats the primer to the correct depth. While this takes place the mouth is varnished on the inside, and when the

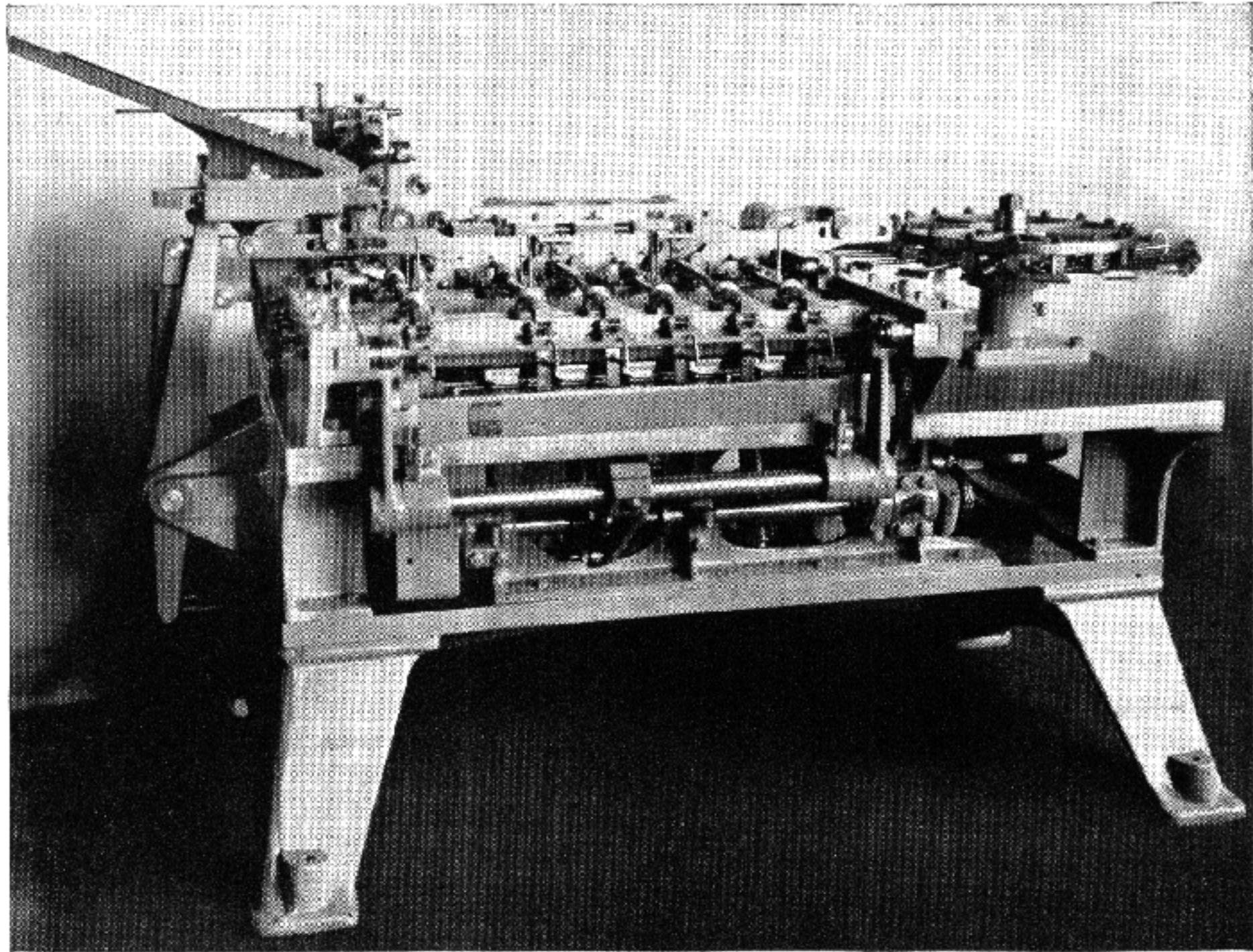

Fig. 164
Machine for gauging and weighing the assembled cartridge

case reaches the opposite side the primer is varnished, making a completed cartridge case ready for loading.

Case Hardness — The cartridge case is made slightly smaller than the rifle chamber into which it fits. When the explosion takes place the internal pressure expands the case, and if the brass is very soft it will not spring back sufficiently after expansion to prevent its adhering to the walls of the chamber. This leads to extreme difficulties in extraction, and the case is liable to blow out the rear when external pressure is at its peak. On the other hand, when the brass is harder, it springs back extensively after expansion; therefore the extraction difficulty is avoided; but hard brass is more likely to split or crack during the expansion. Hard cases used for rifle work do not perform as satisfactorily in machine guns as cases made softer for this purpose. A case made for machine-gun use can be employed for rifle purposes, but extreme hardness is not good practise in any cartridge case.

Degrees of hardness vary at different parts of the case. The case should be hardened at the head or base end, and gradually get softer toward the front. It is softer at the rear end, which is chiefly responsible for the extraction difficulties one often

experiences with some makes of ammunition. If the front end of the case is too hard, there is greater difficulty of internal stress in the metal, and the brass is liable to split spontaneously in course of time. These splits are termed season cracks. The hardness about the center should be intermediate between that of the base and the neck. An unsuitable distribution in the rate of hardness may lead to fracture of the case in extraction, particularly when a rifle has the maximum head space. Extensive and careful research work was done in the laboratory at the arsenal on the question of the ideal hardness for different portions of a cartridge case, and was determined upon for future defects, or as near as it was possible to decide, provided the metal is not at fault.

The instrument most commonly used for making tests of the hardness of cartridge cases or any other form of sheet metal, is a special form of Brinell hardness-testing machine. The operation consists of measuring the diameter of the depression caused by a hardened steel ball of given size after the application of a known weight. The Brinell hardness number is the figure obtained by dividing the load into kilograms by the area of the depression in square millimeters. As the Brinell hardness number obtained with any given material depends

on the size of the ball and the weight used, comparative results can only be obtained where one combination of ball and weight is used throughout. In the case of small-arms ammunition, where the materials are thin, it has been found convenient to use a 1-millimeter ball and a weight of 10 kilograms.

The ideal hardness of a cartridge case as indicated by this scale is as given below:

DISTANCE FROM BASE IN INCHES

0.15
0.2
0.3
0.7
1.2
1.6
At Neck

BRINELL HARDNESS FIGURE

145 — 155
140 — 150
140 — 145
130 — 140
125 — 135
110 — 120
90 — 95

As it has been explained, the making of a cartridge case consists of blanking a disc out of a sheet of brass and forming this into a shallow cup. The cup is then drawn through two dies by a punch to reduce the walls and make the cup much longer, and this operation is repeated until the original blank becomes a long thin tube closed at one end. The end is then headed, the primer pocket formed, and the entire case machined and tapered by other operations until it takes the outlines of a cartridge case. Brass when pressed or rolled or otherwise worked when cold and distorted becomes harder and more brittle, until it becomes impossible to work it any further. It must then be softened by the process of annealing, which consists of heating it at a suitable temperature and afterwards quenching it in water or allowing it to cool slowly. The ultimate hardness of the various parts of a cartridge case is regulated by the arrangement of the operations, which are so figured out that the amount of distortion to which each part is subjected subsequent to the final annealing, produces the degree of hardness required. It is probable that the ideal hardness of the finished cartridge case at the various points cannot be obtained by any method without applying laboratory exactitude, but with careful control of the processes of manufacture, and of the annealing, the desired results will be achieved within reasonable limits. It will, therefore, be clear that variations in the annealing produce different effects on the quality of the finished cartridge case, and that careful annealing is very important. The amount of softening obtained in a given time is

greater if the annealing is done at a higher temperature, but a temperature of 1350 to 1400 degrees Fahrenheit is not permissible, as the brass may become "burned" and its structure destroyed.

Owing to the importance of all the annealing operations, the temperature of the annealing furnaces as well as the body- and point-anneal devices, should be carefully watched, and test pieces removed from all the furnaces to check on the pyrometers. The test pieces should be submitted to the Brinell test, polished, etched, and their microstructures examined. Such a method of examination affords a ready means of judging the true condition of the structure of metal as well as the temperatures in the furnaces.

Bullet Experimental Factors—The essential factor governing a good bullet is balance—the correct proportions of the component parts—accuracy of concentricity. The greatest errors are often due to manufacturing conditions, which affect the accuracy of shooting. The want of a perfect center and form in a bullet is by far the most serious. Whenever the center of mass is not truly on the axis of the bullet as it travels up the rifle barrel in a spiral, and the bullet departs to the opposite line on which its center of mass happens to be traveling at the moment the bullet leaves the barrel, regardless of whether the delivery is from a perfect muzzle or not, the unbalanced part will be thrown away from the center of the barrel. Should the center of mass be only 0.001 of an inch away from the axis of the barrel, it will cause an error of a good many inches at a range of 600 yards, which was our standard range at the arsenal proof house. Many elements besides that of an eccentric bullet enter into these excessively large targets, as we shall discover later. The various sizes of targets obtained from a series of shots with bullets out of balance or out of true when delivered at the muzzle will often be increased because of this eccentricity. At the high velocity in which a Springfield bullet leaves the muzzle of the barrel, the centrifugal force due to the center of mass of the bullet being eccentric to the axis of the rifle barrel is very large (0.001 inch is equal to about four times its own weight), and this causes the bullet to cut deeper into the rifling on one side and increases the eccentricity, so that a very small error in perfect proportion of the bullet may mean a much larger amount of eccentricity at the point of delivery (the muzzle). The extent to which this happens depends on the hardness of the jacket and various other factors in the bullet-assembling operations, so that extreme concentricity of all tools used in assembly of the bullet is very desirable. "Eccentric cups" in the

bullet jacket are a more serious fault even than similar defects in a cartridge case; extreme regularity in the thickness and hardness of the bullet-jacket metal is most essential.

Cupro-nickel is the metal used in most military bullets, because of its less poisonous effects on wounds. Almost all the sporting types of bullets produced in England and Germany are manufactured from this metal. Good cupro-nickel is essential for the manufacturing of good bullets. Whenever it is too hard or brittle, the bullet jacket is liable to split and break up in flight; and whenever the quality of the metal runs bad there is always trouble to look forward to in metallic fouling in any rifle barrel.

Cupro-nickel is one of the hardest of bullet-jacket metals to produce, one of the principal difficulties being the prevention of oxidization. When the ingots are not correctly made, the metal is spoiled; hence great care is taken in testing the ingots before any attempt is made to roll them into strips. When making cartridge-case brass an analysis of the brass is taken on casting, and from then on the annealing is the most important operation; each batch of metal is identified by its annealing

record, but in the process of cupro-nickel it is the practise to take a sample of the ingot and put it through the whole of the manufacturing process. The mills that make it, in fact, should have the proper facilities so that bullets can actually be fired at the ranges to see just how the metal performs; and thereafter such a batch should be graded and identified by the records of its trials from the casting stages to the actual firing test.

The annealing of cupro-nickel also requires great care. The temperature should be between 600 and 680 degrees Centigrade, and on no account should it be allowed to go above 700 degrees, as at this temperature the carbon in the alloy, which is always present with the nickel, changes into the graphite state, and the alloy becomes intensely brittle and the metal is spoiled. The prevention of oxidization during annealing is also important. Cupro-nickel which after rolling reaches a Brinell hardness of 180 should, after annealing, have a hardness of from 80 to 90. After each annealing, samples are taken and tested mechanically, and the microstructure examined.

The usual military bullet, and also the more modern sporting type of bullet, are made with jackets. Both bullets consist of a core of lead covered with an envelope called a jacket, which consists of harder material, such as cupro-nickel, copper, or gilding metal, which is a copper alloy. Bullets can be made of soft steel, coated thinly with some anti-friction metal or alloy, by the electro-plating process; this kind of bullet should be employed only when copper is scarce and not easily procurable, due to war and blockade. Lead bullets of the old standard types are useless today, as, apart from consideration of penetration, modern high velocity would cause the soft metal to strip instead of following the spiral of the rifling in the barrel. At the same time a certain degree of plasticity is requisite in order that "windage" may be avoided. Thus a lead core with an exposed or sealed base, combined with a jacket of harder material tapering off to the rear, provides the desired combination.

The steady growth of opinion has brought the boat-tailed bullet forward as an accepted standard. Its purely ballistic aspects are treated later in this chapter, but there are certain other points connected with the design of this class of bullet that deserve special notice. It has been stated that the sealing of the bore is affected in some measure by the "upset" or increase in diameter of the rear part of a flat-base bullet caused by the gas pressure as it is driven through the "lead" or into the "throat" or conical entrance to the rifled portion of the bore, and because of this a certain plasticity is pur-

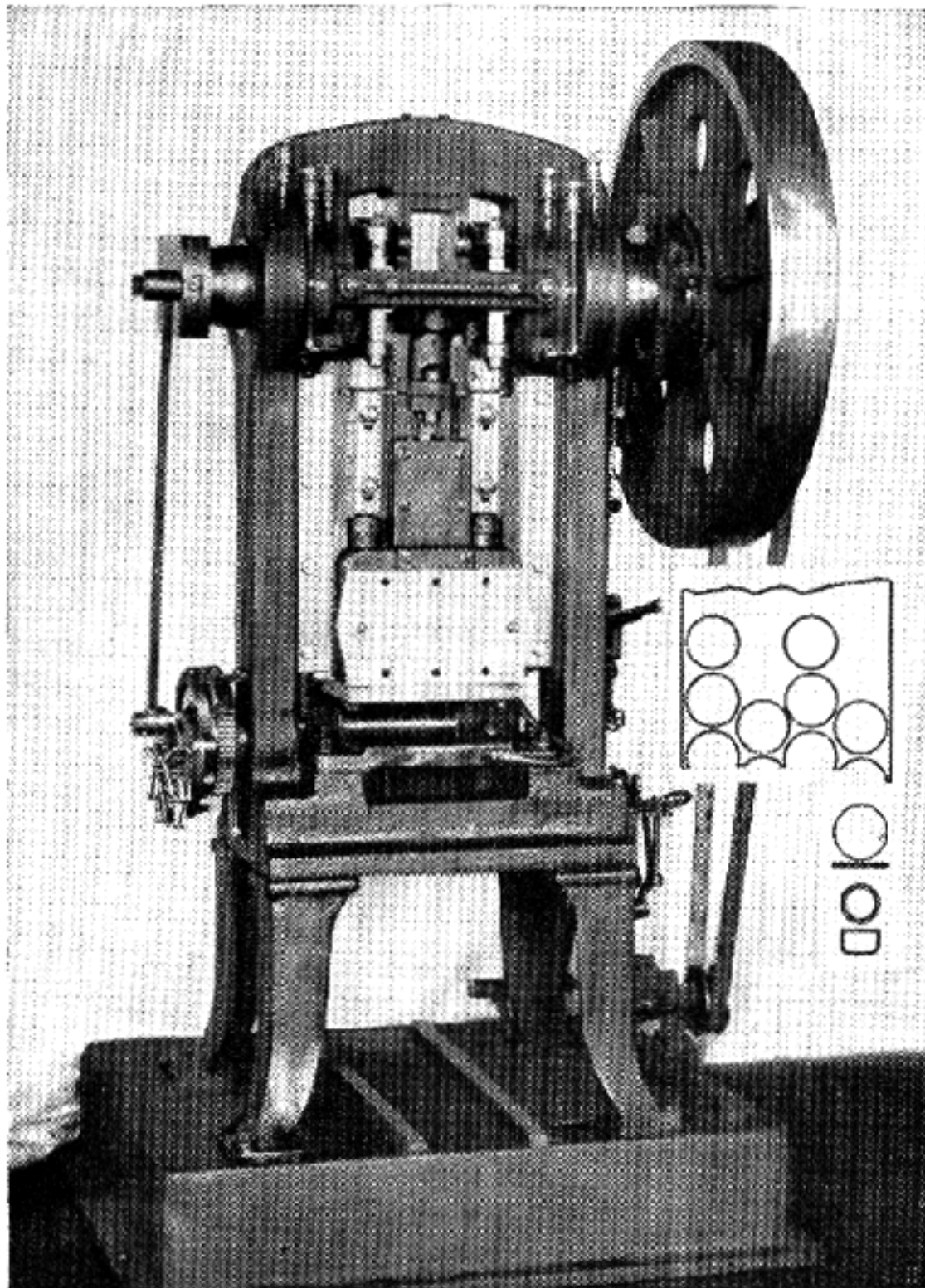

Fig. 165

Double-action press, used to form the cup, the start of a bullet jacket

posely retained. Theory is often advanced to show that certain conditions cannot exist in a boat-tailed bullet or account of the fact that pressure cannot act on the reduced area of the base alone and would defeat the purpose of "upset." The only factor required is a perfect circle at the break from the cylindrical portion to the slope of the taper; there the line must be very pronounced and sharp, also with the correct angle; therefore on such a bullet deformation is not needed to obtain ballistic advantages from "upset."

A boat-tailed bullet necessitates the bullet being loaded deeper into any case; therefore the extreme importance and increased difficulty of insuring exact concentricity of bullet and case where the length of bullet is restricted to a given distance from the end. This is especially true of a bullet of this design; if it requires too great a "jump" before engaging the rifling it is almost certain to be more or less unstable in flight. However, in order to obtain all the advantages of a tapered bullet, it must be parallel to the position and form of the "lead." Such assembly requires the greatest of care with tools, machines, and gauging.

Forms of Bullets — The usual problem is that of determining all the proper shapes of bullets and pointing out the various factors which must be avoided in general practise. The trajectory of a projectile depends upon many factors, such as the components, the initial velocity, its weight, shape, estimated value of spin, the density and temperature of the air, the direction and velocity of the wind. Most of these factors are capable of taking many values. If tables were made covering all cases, they would depend upon as many arguments as there are variations; however, if there were only ten different bullets to be considered, with ten different weights, and if all other factors were constant, then tables could be made and a standard could be arrived at; but to enumerate all would require many chapters and years of study.

Let the shape of the ogive be first considered. Photographs of bullets in flight show that immediately in front of the projectile moving with a high velocity there are cylindrical condensations of air whose diameters are sensibly equal to the diameter of the bullets themselves. This would hold true whatever the shapes of their noses or ogives, as

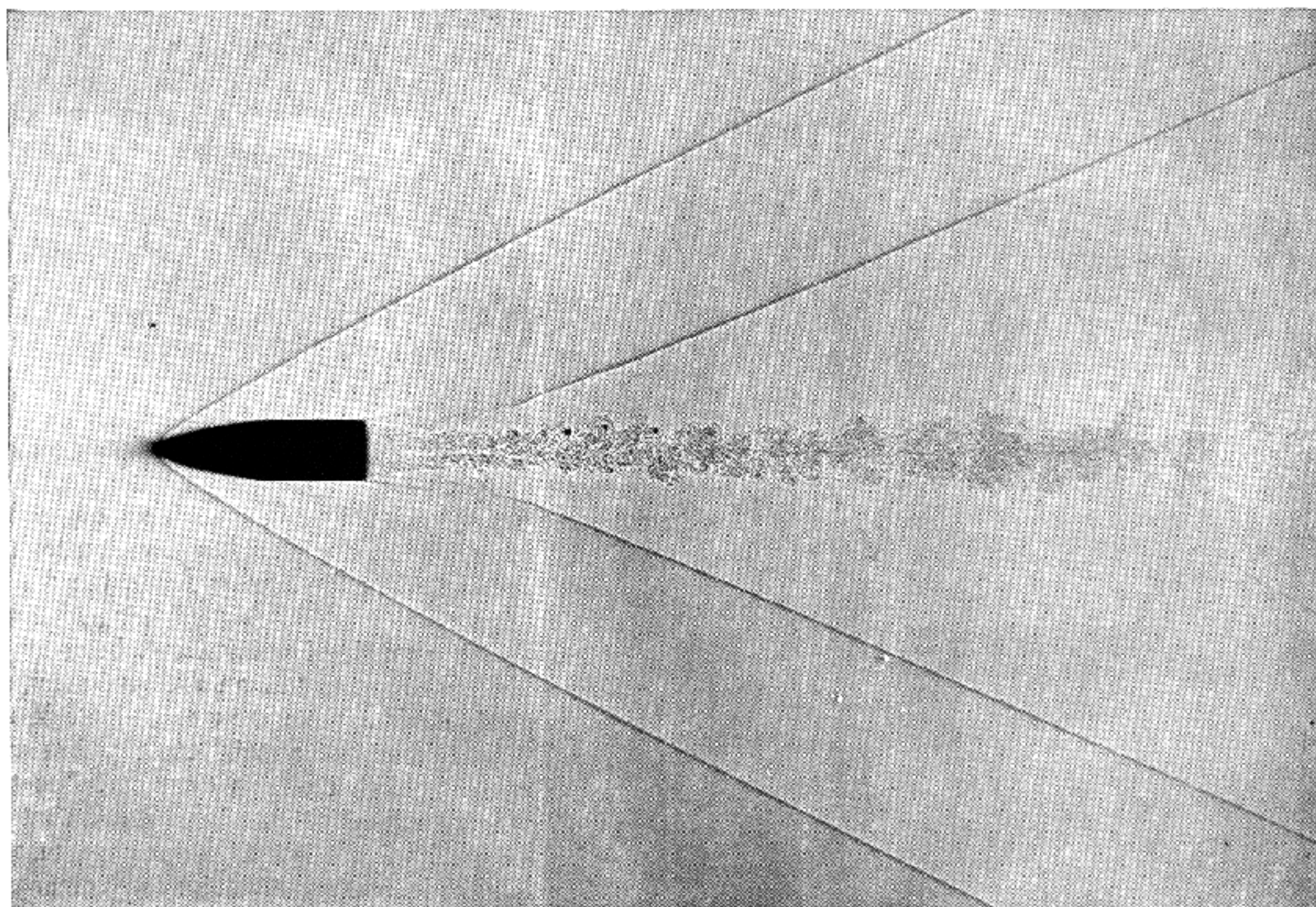

Fig. 166

Caliber .30 flat-base bullet in flight. The two lines at an angle from the point and base are the parting of air as the bullet travels in space. Note the difference in air resistance at the base of this bullet as compared with the boat-tailed design shown in Fig. 149

shown in Figures 149 and 166. Not only is it true when bullets move forward, but also when they move slightly obliquely. This would mean that the points act sensibly as rough bodies, probably because of the high velocity penetrating heavy saturated air. This conclusion respecting the retardation of a bullet as a function of the shape of its nose is illustrated in Figure 167.

“jump” and “vibrations” and other small oscillations of the bullet as it passes down the bore. Therefore, the subsequent motion of the bullet depends not only upon the magnitude of these various rotations as it leaves the barrel, but also upon its dynamical properties. If it has such properties of inertia and spin that its oscillations can be measured, even within small limits, under the conditions

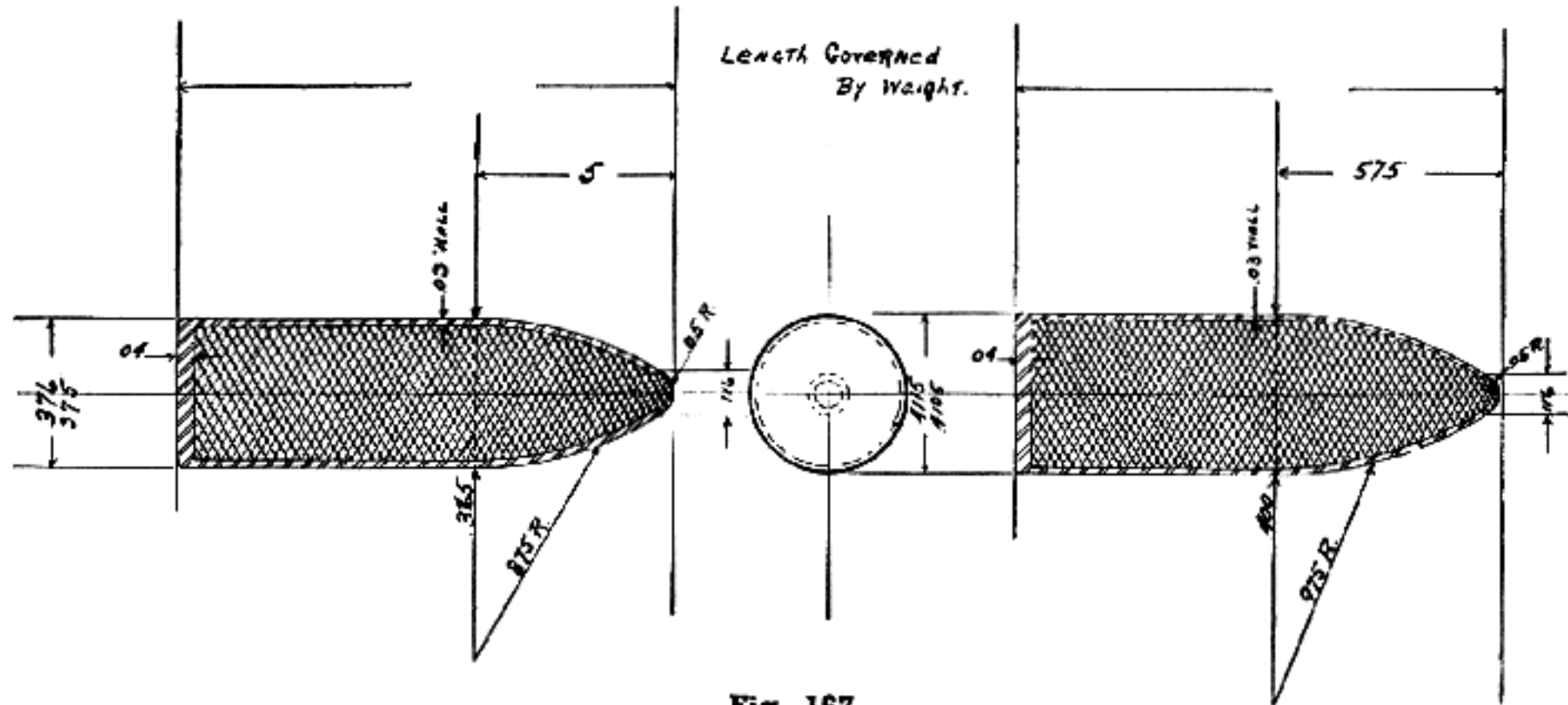

Fig. 167
 Caliber .375 and .404 bullets. The nearer we approach to great cross-sectional area, the better the kills in a sporting type of design

Bullets must be designed with three or more calibers for an ogive. Most bullets made of lead had noses of one or two calibers, but because of increased velocities and the demand for increased ranges the ogives were increased in length and given a metal jacket. The assumption on which results are obtained represents the physical facts only roughly, yet the results agree fairly well as you advance in experience. But it must not be supposed, if a five-caliber radius gives good results, that a ten-caliber would give correspondingly better results; for there is a danger of bullets becoming unstable when their ogives are greatly increased in length. However, the loss of energy in tail waves does not diminish as the ogives are increased in length. Consequently, Figure 166 gives only a rough indication of what would be found; but experience would prove the facts. The momentum is imparted to the whole mass of air encountered by the ogive while the bullet moves through space. It is not difficult, in view of the above facts, to figure out the conditions which must be satisfied by the surface of the ogive to give minimum air resistance.

When a bullet leaves a barrel under normal conditions, its axis will very nearly coincide with the direction of motion; it will then have a rapid spin about the axis, imparted by the rifling in the barrel, and it will also have much slower degrees of rotation about the axis because of such factors as the

prevailing in the firing of the bullet, it will be said to be “stable.” On the other hand, if it has such properties that, except in special initial conditions, it will oscillate erratically, it will be said to be “unstable.” Only actual firing trials can reveal the ideal combinations in components, bullet assembly and proper balance.

How to make a perfectly balanced and designed bullet will always be an open question. Those who experiment upon bullets usually try to improve upon an accepted standard or upon certain existing conditions. True, there is a large field in which to bring out a better product; but the experimenter must use various metals and alloys, assembling them in such combinations that perfect balance and symmetry are the paramount issue. The specific gravity of a metal must be first considered. We cannot expect to use gold or tungsten and secure the same results as with copper, even tho given a high velocity, when copper alone is employed to secure distance of range. Still, gold might give the desired accuracy, but the angle of departure would be too great; therefore, what is required is nearly a flat trajectory instead of a large arc. Certain combinations of metals can be employed, making what is known as compound bullets. The British Service Mark VII bullet is an example of the manner in which the compound bullet enables weight to be reduced without a corresponding reduction in

length. In such a bullet, the lead core is at the rear, while an aluminum tip is placed in the point. The weight is 174 grains, as against 196 grains for a bullet of equal dimensions but with a solid lead core.

The tip of any bullet can be filled with any lighter material, not necessarily aluminum; for instance, fiber, hard rubber, or compressed paper. The experimental determination of the flight of such a bullet must be well worked out in order to have the lighter metal at a given weight; therefore the resistance offered by the air to such a bullet depends, in the first place, upon targets secured in every fifty yards up to one thousand yards, by shooting ten shot groups from a machine rest. The results will indicate the most suitable weight of tip to use. Then we take into consideration the chief factors that determine the trajectory of a given bullet in flight; after which we must consider the components of initial velocity, the acceleration of

gravity, the normal retardation of the atmosphere. In addition, however, there are many minor factors, such as winds and abnormal air densities, and these vary with time and location, and cannot be determined by theory alone.

Bullet Weight — Bullets of a given type are supposed to have a standard weight, but there are actually some variations due to tolerances permitted in the manufacture. However, in the experimental tests, the projectiles should all be of a given weight and only have a plus or minus of one grain. Select, as an example, a number of bullets to weigh 172 grains, the next lot 173 grains, and the next 171 grains; 172 grains is the mean figure, and the other two figures are the plus and minus from the mean. Two grains in weight as a manufacturing tolerance is sufficient, and any well regulated machine can or should produce bullets within such wide limits. If a bullet is overweight, its initial velocity is reduced by a certain amount, naturally depending on distance and its normal velocity, the gun and the powder charge. The relationship is established by experimental firing. There is consequently a change in the initial condition, whose effects are determined by methods established at a well organized proof house.

Normal trajectories are determined under the belief that the air is stationary with respect to the surface of the earth; but there are nearly always winds, and even vertical currents, sufficiently strong to modify appreciably the flight of bullets. It is necessary to regard their effects as abnormalities that must be taken into consideration by means of weighing factors because of their ever-varying character. There are, in fact, usually considerable variations of air currents, in both velocity and direction, at different altitudes above the surface of the earth.

Explosive Bullets — The term "explosive bullet" was used in the days of black-powder, large-bore rifles, to designate a large lead bullet in the nose of which an explosive element had been placed, this acting on impact. Today, with our high velocities, an explosive substance is not necessary. All that is required is an open point in any bullet; an explosive effect follows as soon as such a bullet strikes flesh. Whenever additional stopping power is obtained by exposing the lead core, or by drilling into the end of any full metal-patch bullet, or by weakening the jackets at the nose in various manners, such bullets are correctly described as expanding bullets. The destructive effect on bone and tissue is greater than that caused by a full metal-patched bullet, and it is an effect very differ-

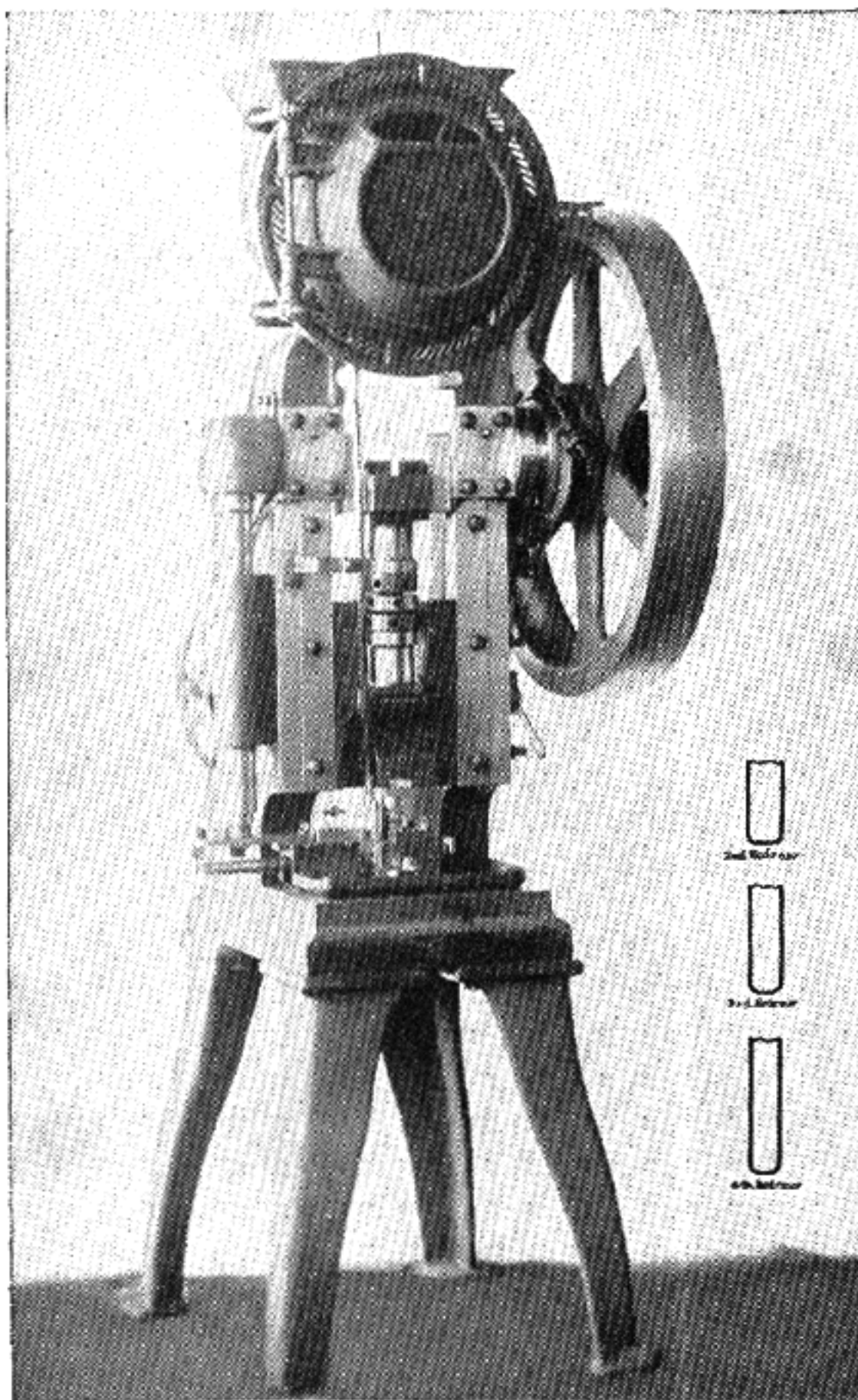

Fig. 168
Bullet-jacket draw press for second, third, and fourth redraws

ent from that of a bullet opened by the explosion of an internal explosive element.

In order to make the discussion more concrete in the matter of expanding bullets, consider the practical side of their use and their determining effects. One of the first factors to be considered is distance: the thickness of the jacket must be such that the same expanding effect can be secured between one hundred and three hundred yards. The relative simplicity of construction does not make such a bullet effective until tested out for complete efficiency upon not only live but dead tissue at various distances. In fact, a complete knowledge of the effects would require extensive study with various weights and diameters of bullets.

Explosive bullets were designed and used in the World War by different nations, chiefly against aircraft and observation balloons; but when one is made for a small-bore arm the construction of component parts becomes the same as making a watch; therefore the smallest size worth considering is a .50 caliber; any larger caliber becomes artillery ammunition.

We designed one at the Frankford Arsenal known as the .50-caliber spot-light bullet, one of the most successful types of explosive bullet. This bullet has the supersensitive nose which is capable of exploding upon impact on tissue paper. The name spot-light was derived from the phosphorus which it contained in the base. To make a true explosive bullet, the base could remain sealed and the high explosive element could fill this cavity.

The practical importance of obtaining the desired efficiency of such a bullet and the factors governing its experimental use is only to prove certain destructive forces, and to determine the variation with the more easily constructed expanding bullet. It is obvious from this discussion of expanding and explosive bullets that the practical use of the latter would be in warfare alone; but the former is practical for the big-game hunter, particularly one who must face dangerous animals. In establishing effective results one must choose a large-caliber bullet and besides must consider the rifle with care; a double rifle with a practically designed bullet, duly proved by one's own experiments, is probably the most desirable.

Bullet Design — The history of the evolution of rifle bullets is so intimately associated with that of weapons that a detailed description of its development would involve a great deal of unnecessary repetition. Very few men care for a detailed description of the past designs of bullets, altho this might be interesting to a certain extent; the modern mind is most keenly interested in the appearance

of new ideas from the experimental laboratory, whether in the large manufacturing establishment or in the basement shop of the creative amateur.

Altho low trajectories and light fixed ammunition are eagerly sought today, experience indicates that the existing limits in calibers are likely to create a separating line between large and small calibers, giving us heavy bores not greater than .375 and small calibers from .30 down to .15 in size. Today we have calibers in the large bore from .375 to .600 and the small calibers run from .350 to .22. Bullet weights average from 40 to 900 grains.

The claims of the boat-tailed bullet are firmly established, with the exception of the lead bullets universally used in certain small-bore arms. Gilding metal or pure hardened copper jackets are fast replacing cupro-nickel in sporting bullets. There may be found a satisfactory soft steel which can be worked as cupro-nickel or copper, and if it is, it will be one of the standard envelope materials of the future.

One of the most important considerations in bullet design is to advance in the direction of boat-tailing, as before stated. This should be termed "stream lining," as we are applying this principle to motor-cars, buildings, boats, etc. In the United States we must express the subject in the most advanced manner, using modern terms. During the development of this bullet at the Frankford Arsenal we early learned to recognize the ballistic advantage of the rear taper. Our first trials in the use of boat-tailed bullets were not what you would call a success, so far as the desired accuracy was concerned; but this was due to not having the proper machines or the correct tools; after these were developed, accuracy was obtained.

Boat-tailed bullets should be employed for all match shooting. Men who limit themselves to service standards as regards the caliber .30 Model 1906 ammunition, using sights and methods of exceptional merits, should interest themselves in exploring the possibilities offered not only by the improved bullet, but also as regards the chamber, barrel, and cartridge case itself.

Knowing the present trend toward flatter trajectories—toward lighter bullets propelled at high velocities—one must first become reconciled to the theory, and then secure actual results by experimenting. Along with the development of high-speed bullets it seems desirable that we should learn something more definite about designs from actual firing trials, by using bullets first turned from solid brass, copper, soft steel (coated with some anti-friction alloy before firing through the barrel), bronze, etc.

In spite of much care and forethought the experimenter will encounter many failures when designing any new bullet and testing it at the range. Knowing that the greatest range of calibers is between .25 and .375, it is best to confine the various designs to bullets in these bores in the high-velocity class; therefore we have these calibers to make our selections from: .25, 6.5 mm. or .256, .270, 7 mm. or .276, .275 Magnum, .280, .30, .303, 8 mm., .318, .350, .375. The reasons for the above choice are to be found in the cartridge cases to accommodate the bullets designed.

There are two cartridges using bullets from 70 to 100 grains which may have an opportunity to present themselves for certain improvement: the .22 high power and the .242 nitro express. In spite of the record performance of bullets of this type, it can be considered that their use, except only in an extremely limited degree, is still an experiment. Small-bore high-velocity bullets, if not designed from accepted standards, are likely to lead to many disappointments. Military bullets are designed to serve a definite purpose, whereas a bullet designed for sporting purposes has unlimited possibilities. Unfortunately, a great deal of misconception exists regarding the correct interpretation of ballistic data in bullet design, which results in disappointment from various angles, often due to the gross over-taxation of the capabilities of even the most efficient small-bore bullet.

The United States, Switzerland, Germany, and France are the four nations that have made the boat-tailed bullet an accepted standard up to the present writing. France uses a solid bullet of a copper-zinc alloy, whereas Switzerland and Germany use one composed of a jacket and lead core. All the other nations use flat-base bullets with either a spherical or an ogival point; the latter is by far the most popular. The wounding power of the military bullet is considered satisfactory from the humanitarian point of view. The effect of the blow imparted is sufficient to place men out of action in many instances, when vital parts are not penetrated; but why bring such philanthropic thoughts into consideration, when other destructive agencies are made with far more deadly effect?

The .30-caliber boat-tail bullet now used by the United States Army, with its great velocity and penetration, makes its impact hard to feel in many cases, and its track through the body is a clean puncture without circumferential damage of any kind. Unless bone be hit, therefore, stopping power is lacking. Warfare is horrible at its best, but it is war, and there is no reason why small-arms projectiles should not be as deadly as other agencies of war, placing men completely out of action.

Warfare cannot be considered civilized, and why rule out certain small-arms projectiles because they are more deadly? Observation of actual wounds from small-arms bullets in battle would seem to be the best means of settling this question, tho many other factors enter into it. The finding would no doubt show that the more deadly effects of the expanding bullet completely eliminate the suffering caused by modern bullets. Many instances have been known of soldiers constructing their own expanding bullets by filing off the points and exposing the lead. Rubbing off the point of any bullet on a rough stone is sufficient to make it one of the most deadly of expanding bullets.

Designs — The designer of modern bullets will find it necessary to emphasize the fact that no matter how much skill and care are given to the designs, his labors will be wasted unless the powder is carefully selected and developed with careful understanding. The designer of small-arms projectiles is confronted with various problems and surrounded with various restrictions—many of which can be safely disregarded.

It has been assumed that the axis of the rotating bullet is always parallel to the tangent of its trajectory. Under this ineffective assumption it was sufficient, in treating normal trajectories, to consider only the acceleration of gravity and the retardation of the atmosphere in the direction opposite to that of the motion of the bullet. While this is not a solution of the whole problem of the bullet's motion, it is a good approximation to it in the case of a well designed bullet, and results in a great simplification in the trials. This is advisable, particularly because it is necessary to secure an insight into the physics of the problem, and then to develop the analysis so that the physical constants can be determined from experiments without serious difficulty. Furthermore, the problem will be so analyzed and treated that the principles determining stability and related questions will be clearly brought out and put in such a form that they can be used in the design of any bullet.

The modern bullet components consist of a jacket or envelope of harder material, and the lead core usually consisting of nine parts lead and one part antimony, or eight parts lead and two parts tin. The bullet must be made so that when it is assembled, and the envelope turned over at the base, the lead will come flush; therefore weight alone governs this component.

Having completed the operations to this stage, the design can be carried out to any desired form which will prove the most suitable for accuracy, whether flat base or the end given a taper of any

degree. Since it is obviously necessary to boat-tail the base for better ballistic values, it is better to carry out the design in that direction.

Armor Piercing—Modern military requirements also include armor-piercing, tracer, and incendiary bullets; the basis for the envelope is the same. The armor-piercing bullet is designed for greater penetration than that of the ordinary service bullet, as it is not possible with a caliber .30 bullet to penetrate certain thicknesses of plates, or armor carried by tanks, armored cars, aircraft, etc.

It is found that the greatest penetration is obtained by a hardened steel bullet inserted in an envelope. Therefore, the design takes the form of a hardened steel core enclosed in a jacket which enables the bullet to take the rifling. A lead point is provided between the point of the core and the end of the jacket, this acting as a lubricant upon impact for the core when harder plates are encountered as well as plates placed on various angles. Extreme accuracy, therefore, is not essential, as there is little advantage in the use of such a bullet over 1000 yards.

The penetrating force of an armor-piercing bullet depends almost entirely on the striking energy of the steel core. Both the weight of the core and the velocity should, however, be as great as possible. The weight of the core can only be increased by making the core diameter as large as possible, and this means that the wall thickness of jacket must be made as thin as possible. High velocity also involves high pressures, and an armor-piercing bullet is therefore found to put great strains on the rifle or machine gun, and owing to the hardness and rigidity of the bullet it would no doubt cause excessive barrel wear. The total number of armor-piercing bullets fired from any rifle or machine gun during its life is not necessarily great, however, and the cumulative destructive effect is not likely to be serious.

The form of the core to some extent affects its penetration. A pointed core gives better results upon normal impact than a flat-nosed core, even on oblique angles. The ogive of the core's point is, however, chosen for the best all-purpose performance. At longer ranges the ballistic efficiency is of importance, and the external ogive and boat-tailed angle is also of particular importance, so that the velocity is reduced as little as possible by the resistance of air. With cores made of $3\frac{1}{2}$ per cent tungsten steel, and given the proper heat treatment, this bullet should penetrate an armor plate which would measure 0.35 inch in thickness at 100 yards, practically every time hit.

Tracer Bullets—These are so called because they leave a visible wake or "trace" behind them, so that the correct range and object can be found, particularly when fired from an airplane or when fired from a rifle, as the trajectory can be seen. They are used to ascertain visually where the bullets are going, with the object of correcting the aim, and it is therefore essential that tracer bullets should have approximately the same trajectory as other service bullets. Unfortunately the trajectories of the ordinary service and armor-piercing bullets differ somewhat, owing to the greater velocity of

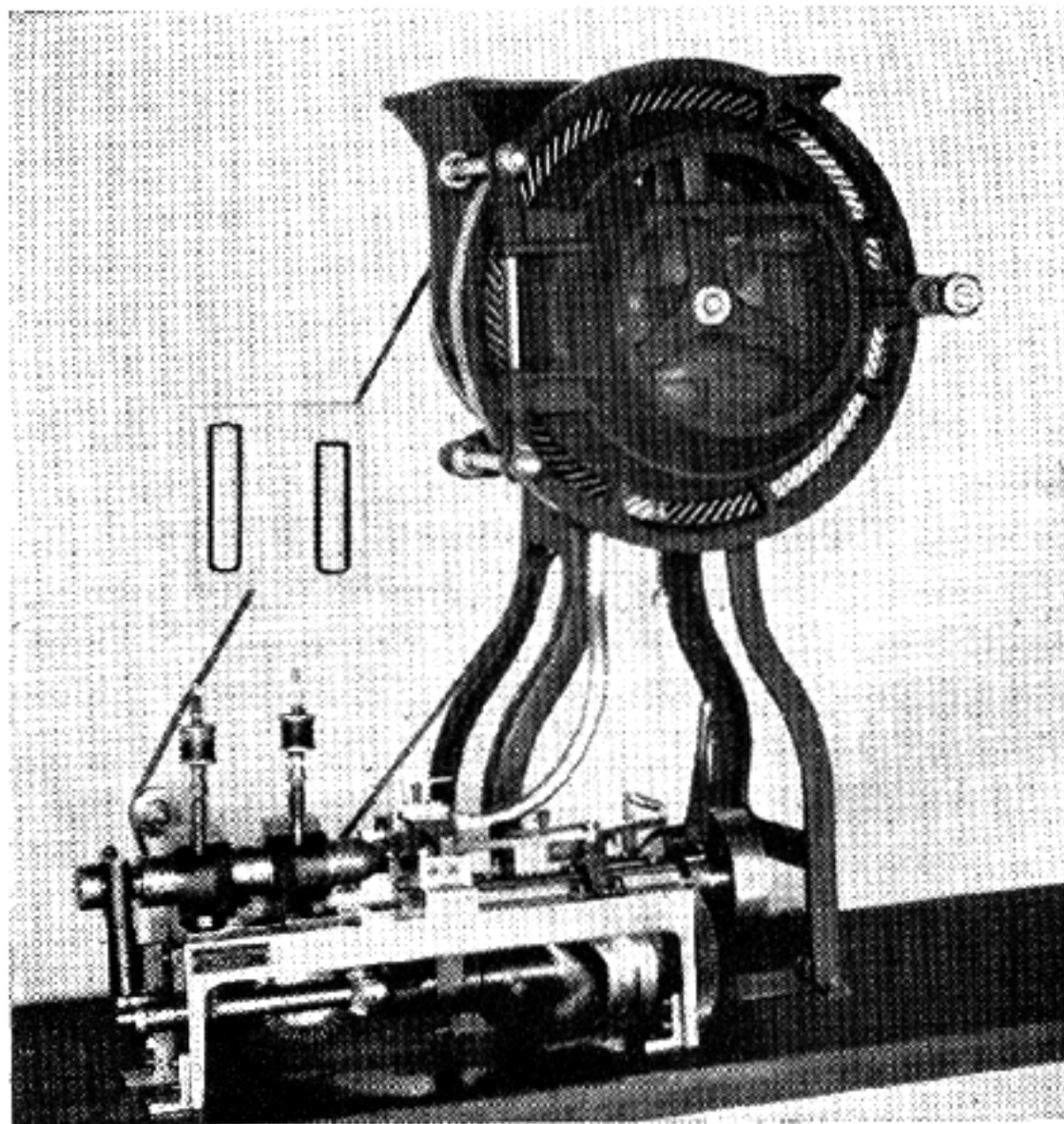

Fig. 169
Automatic-feed, bullet-jacket trimming machine

the armor-piercing bullet, and it is not possible to imitate the trajectories exactly.

The trace, or trail of fire, is obtained by filling the bullet with a composition which is ignited by the powder gases when the explosion takes place, and which burns during the flight of the bullet. From the time the projectile leaves the muzzle until the composition is completely consumed the bullet is continually becoming lighter, allowing more weight at its point. The curve of its trajectory is consequently not the same as that of an ordinary service bullet, whose weight does not change. It is possible, however, to design and make a tracer bullet which, up to a range of 1000 yards, has a trajectory sufficiently close, for practical purposes, to that of the service bullet. Armor-piercing and incendiary bullets do not differ much in trajectory up to this range. Beyond this range the path of the bullet is erratic, but this is of no great con-

sequence as the tracer composition is about consumed.

The caliber .30 tracer bullet used for the United States air forces is composed of an envelope, lead point, and copper-alloy composition cup; but the modern design would be to apply a boat-tail to the bullet for better ballistic results. The composition cup and lead point are assembled first on the bullet-assembling machines, and then the bullet is placed in a loading die and filled with a mixture of barium peroxid and magnesium powder. A punch is then put over the composition in the die, and placed in the loading press, and the composition reduced to a solid under pressure. After loading, the bullet is given the taper to its base, then loaded into the case, the tracer composition being ignited by the flash of the powder.

This bullet may be used in all types of caliber .30 Model 1903 arms, and will function equally well in all. When fired for accuracy at 600 yards from a fixed rest, all the shots should be in a four-foot circle—a performance which may be equal to the armor-piercing but which does not compare favorably with the service bullet. A tracer bullet is very destructive to the barrel in which it is fired. The bore rapidly becomes eroded, and there is a tendency for the inside to become coated with a hard metallic deposit which is not easy to remove when it is left in for more than a short time. The most satisfactory way to clean the barrel of this deposit is to fill it with the powder solvent given in Chapter XXV. When firing tracer bullets it is desirable to fire armor-piercing and incendiary bullets at the same time, using these alternately, five rounds of each type, as this has a decided effect in reducing the residue left by the tracer composition.

Incendiary Bullets — Altho it was necessary to design a bullet with which to set fire to objects hit, such as airplanes, dirigibles, etc., during peace times such a bullet is not required. The term "incendiary" refers to a bullet capable of burning or doing great damage by fire. Phosphorus is the agent employed to accomplish that purpose. A small hole $\frac{1}{32}$ inch in diameter is pierced a given distance from the base, and is sealed with a soft solder capable of melting at 150 degrees Fahrenheit. The object of this hole is to allow the escape of the gas produced from the phosphorus as the bullet is passing through the barrel and through the air. As the phosphorus is in a liquid state, this vent acts not only as a pressure escapement but also as a trace to indicate the true range. Of course, it is rather hard for the eye to pick up the phosphorus smoke during a high wind, but on a calm day the smoke spiral gives an interesting view both of the

spin of the bullet and of the line of the trajectory.

Upon impact this bullet breaks up, causing a large burst of flame and completely igniting any inflammable material with which it comes in contact. Nevertheless, it is possible to design an incendiary bullet which, up to a range of 1500 yards, would be capable of doing considerable damage with a trajectory sufficiently close for practical purposes.

A bullet designed with a soft soldered point and with the phosphorus located in the center could be used as a spot-light bullet. The purpose of such a bullet would be the quick location of machine-gun fire. It would be used for military purposes alone, and would be required only in time of war; therefore when the necessity comes for such a bullet the army will call for its manufacture.

All the above-described bullets have been made with a bullet jacket or envelope. The only parts which have changed are the substances of which they are made under the various headings. These special bullets may be divided into separate categories, according as they are most suitable for use in the various machine guns and service rifles. Armor-piercing, tracer, and incendiary bullets all are important for use in aircraft machine guns. Therefore it is correct to state that bullets referred to under this heading are specially designed. However, considerable improvement can be made in their design; therefore it is a hard matter to state just what the wars of the future may bring forth.

Expanding Bullets — The results recorded by big-game hunters often deserve critical observation, particularly if they state the type of ammunition and make of bullet used. The endeavor of the big-game hunter is to kill completely and effectively, yet without destroying the meat or marring the beauty of the trophy. He must therefore choose the bullet that has the greatest wounding power, and is known to penetrate, but will not break up or traverse the body of the game. It must maintain its gradual expanding qualities until it spends itself and can be found lying flattened in a mushroom form against the skin on the side opposite to that of entry. The big-game hunter, to be sure, understands the difficulty often experienced with a small-bore arm, in clean kills. With the increased accuracy and flatter trajectory no caliber should be used less than the caliber .30 with a 180-grain bullet of the expanding type, to be driven with a muzzle velocity of 2800 f.s. or even higher.

Experience has taught us that it is difficult to design a bullet which will be as efficient at 50 yards as it would be at 300 yards with the selection of modern designed factory ammunition. Therefore,

in order to accomplish that object, we should design a bullet with a flat nose and an open point in the center of the end. The lead core, instead of being a solid piece, takes the form of a number of sections made of two kinds of metal, one section of hard material, such as copper, and one of metal composed to nine parts lead to one part antimony. Fine saw slots are placed at four points on the ogive; three, in fact, would be sufficient. The object of a bullet designed in such a manner would be, first, penetration, and secondly the holding together of the bullet after the envelope begins to open up due to the two different alloys which compose the core. The lead sections would disintegrate while the harder metal would hold together without breaking up in particles, therefore paralyzing nerves and destroying tissue in a large area. Such a bullet becomes more "humane" in its kills. Under these circumstances the caliber selected should be .30 or larger. The wounding power of such bullets would depend upon the velocity and the effect of the blow struck. Penetration would be assured, and the question which would arise would be what caliber to select for the most dangerous game. A bullet so designed is rather expensive to manufacture, but expense is a second consideration as compared with dependable kills.

The second type of expanding bullet would be one with a step on the ogive. A jacket is selected and formed with a step in the center of the contour. The object of such a design is the destructive effect in tissue and greater penetration. To make such a bullet more effective on ranges longer than 100 yards, drill a $\frac{1}{16}$ -inch hole in the point just through the jacket to the lead core. It has already been pointed out that in the pointed bullet the soft lead core is covered with an envelope of various alloys, and therefore cannot expand on impact where a soft substance or tissue is hit. The only method of obtaining the increased destructive effects in the area hit is to shatter the tissue and nerve centers, bringing death instantly. The use of such bullets in warfare is therefore forbidden by international agreement.

The increase of area on impact of any bullet must be in a direct line. Giving a bullet considerable length in proportion to its caliber will cause it to become unsteady, so that it will often move sideways through tissue. A bullet similar to the 6.5 mm. would be very unstable on impact; therefore, when calibers are reduced we must shorten the bullet in proportion. Length seems to be the chief cause of unsteadiness in a bullet. Often the pointed bullet presents the same unsteady characteristics, due to making the ogive too long and throwing the center of gravity too far back. Unless the ogive is

accurately in the line of trajectory, it immediately, on impact, takes on the motions of a top losing its momentum and becomes erratic in its course.

The choice of a bullet must depend, first, on the type of game that is to be encountered, and secondly on the type of country in which the hunt is to be conducted. After the selection of the properly designed bullets, the next important point to be considered is the rifle, and the choice is a matter of personal selection. All thick-skinned animals require bullets which possess a great degree of penetration; therefore, it is essential that the bullet jacket be heavy, with thicker metal walls than usual. It also becomes almost necessary to eliminate open points entirely and rely more upon the bullet designed for such purposes, with proven results. A well designed sporting type of bullet, particularly one with a small amount of lead exposed at the tip, should be selected and used. It is hardly necessary to say that for elephants a full metal patch is absolutely essential. For heavy, dangerous, thin-skinned game, such as lions and tigers, a full metal-patched bullet is of little effect, altho such animals can quite easily be killed with such a bullet if hit in a vital spot. Killing power, as already explained, is not the only necessity; an animal must drop upon impact. This means that the whole force of the bullet's energy must be utilized instantly to its fullest effect; in other words, the bullet must so expand that it will not pass through the animal.

For the small varieties of non-dangerous thin-skinned animals the bullet must break up more quickly; therefore one with a larger opening in its point is preferable. The varieties of "expanding" bullets placed upon the market are chronicled, and

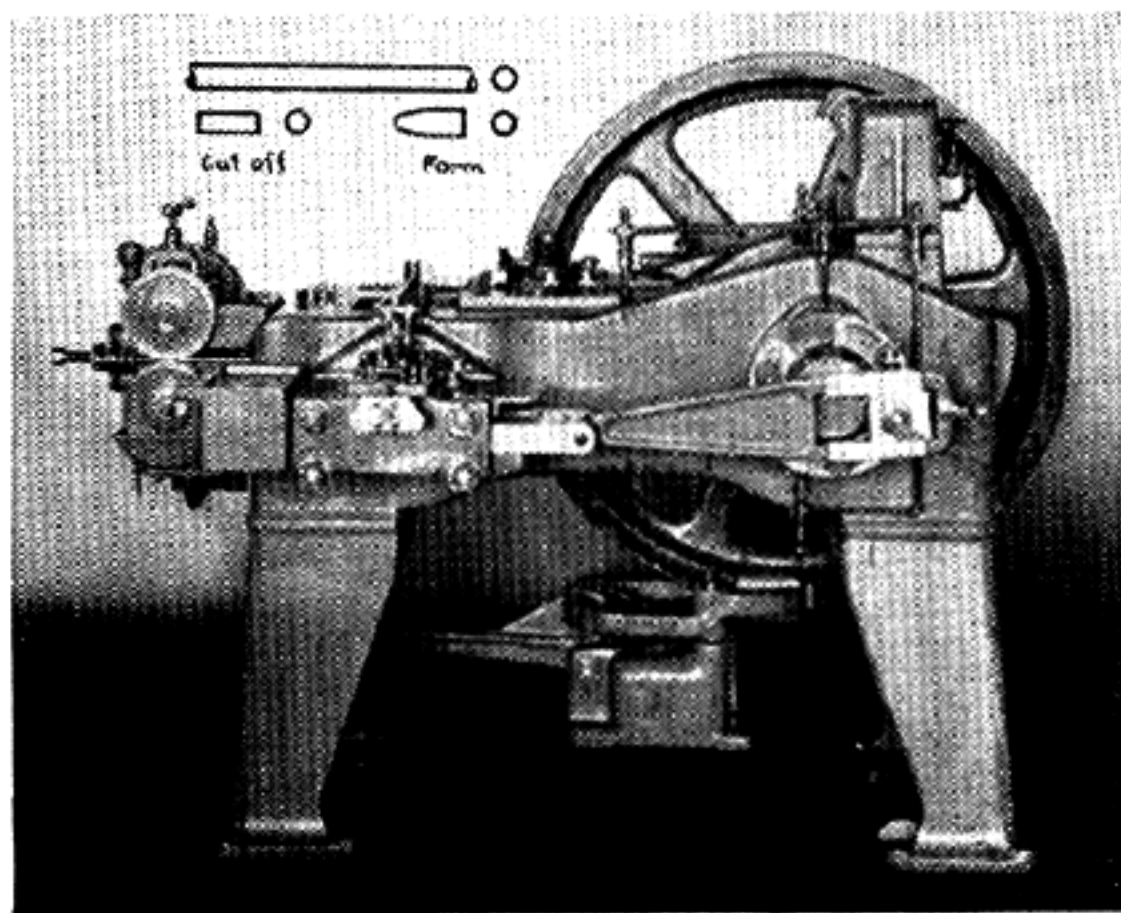

Fig. 170
Slug-forming machine, employed to form the lead cores used in jacketed bullets

no doubt have great merits in their favor, altho you can say none is perfect. From personal observation I have come to the conclusion that the copper-tubed bullet would have great merits and would be extremely effective, altho no doubt some of the more modern designs can also be given special consideration. It is difficult and even dangerous to offer suggestions, but I am inclined to think it much better for the interested person to select various types and experiment upon various substances, such as dead animals, $\frac{7}{8}$ -inch pine boards (placed 1 inch apart), small cans filled with water, clay, paraffin, soap, etc., to see the results of personal choice.

Having expressed a particular choice in selection of bullets for both dangerous and non-dangerous game, it will be well to carry the reader afield with a weapon for the former class of animals first. For use against really dangerous game a rifle must be extremely powerful, and "power" expressed in armament means weight. The weapon, however, must always be carried in the hand, and the weight is therefore limited to a certain extent by the hunter's strength. Nevertheless, facts must be faced. The choice must fall upon a "double rifle" as the most essential weapon. Dangerous animals must not only be given a deadly wound, but must be paralyzed, so to speak, so that even if the wound is not mortal, time will be allowed for the second shot. Here again weight in both rifle and bullet is more important than ever. Therefore the shocking power is essential, and it can never be furnished by a small-caliber high-velocity rifle with certainty. Indeed, for this reason a double medium-caliber rifle with bullets of the proper design will be the best. A heavy weapon is better, providing it is not beyond the hunter's strength.

National Match Bullets — The manufacture of match bullets used in target practise demands the finest of precision tools. There will always be endless experimental designs, trying to find the one that, in the firing trials, will prove itself best suited for adoption. It has been found that the boat-tailed bullet comes the nearest to producing the finest accuracy; still, there is the never-forgotten demand for thorough inspection of metal, selecting the strips of the desired Brinell hardness as well as the uniform thickness, which is to be tested with special dial indicator gauges to find the variations in the metal, so that when the cups are formed there will not be any eccentric jackets even up to the third draw. Special orders should be given the mills so they can keep their rolls ground and bearings in perfect condition to eliminate all possible variations in thickness of the sheets. The start of a bullet-

jacket cup means a perfect projectile upon the finished assembling operation, providing tools and machines are as near perfect as it is possible to make them; but rifles and cartridge case must also be given the proper consideration.

The modern rifleman demands that the long ogival bullet shall perform perfect scores at 300, 500, 600, 800, and 1000 yards. The spiral or rifling in the barrel has solved a part of this problem for him. To understand just how this successful performance was attained, analyze more closely the bullet designs, selecting two bullets, one a flat-base and the other a boat-tail of modern manufacture, but the two with the same ogival point. Both bullets are lightest at their points, have the least resistance there, and receive at that end the greatest support when passing through air. There should be a clear understanding of the important fact that the base end of the bullet naturally falls faster than the ogive. As an illustration we may consider a bullet made up in two parts, the base a cylinder and the ogive a cone, the two having equal bases and equal altitudes; but by extending the base out into a tapered effect, shown in Figure 149, we influence the air pressure, causing a vacuum at the base; this changes the rule whereby the taper at the base is not equal to the cylindrical portion of the flat-based bullet. The flat base retards the bullet, allowing it to make a greater arc when it is falling horizontally, showing the amount of air pressure on the base of the bullet, while the upward pressure on the ogive is half of that on the base; therefore, the forces pulling the base and ogive will be in proportion to their bulk. The volume of a cylinder is equivalent to the product of its base and its altitude, while the volume of a cone is only one-third of the product of its base and altitude. However, the pull on the base of the bullet exerted by the force of gravity is three times as great as that on the ogival point; while the amount of air pressure holding it up is only twice that on the point; therefore the base end of the bullet tends to fall faster than the lighter point. Consequently by designing a bullet with equal ogival points on each end the vacuum and pulling force are equal; hence we find one of the important demands for the supporting force of rapid spin to keep the pointed ogives straight and keep the bullet upon a true course. It is not always practical to give a bullet the same conical points, due to the difficulty experienced in manufacture; but we can give it a certain amount of taper which will reduce the vacuum to a minimum and still come within our desired expectations of accuracy. Figures 149 and 166 will show the different air vacuums created at the base of a bullet starting out with the flat base and ending in a bullet de-

signed to give great distance of flight. The difference in the support which the ends of the bullet receive from the air, therefore, is only one of the factors which throw a modern-design bullet from its true course. A glance at the illustration will show the effects of the air which lies in the bullet's course as it is passing forward.

A bullet once set in motion will move to infinity in its original course unless prevented or deflected. It would continue along a true course were it not for the air it must force aside and for the pull of gravity. The modern jacketed bullet has more buoyancy to travel through space, due to its equal wall construction; but due to air currents it has no fixed point of rest. Analyze briefly the

course each bullet takes in its effort to obey the commands of gravity, air resistance, and rotational force, and you will see why the best designs are bound to face considerable failure. When once a true-designed projectile is found, the best that can be expected is to eliminate all errors in its manufacture; also in the rifle barrel and cartridge case. However, bear in mind that the longer the bullet the more its body will be subjected to the air forces as its ogive is directed from side to side, and that the smaller the bullet the greater the surface exposed in proportion to its cross-sectional area. Again, a bullet must be perfect, with a high polish, so as not to create any unnecessary air friction when shot over a long course.

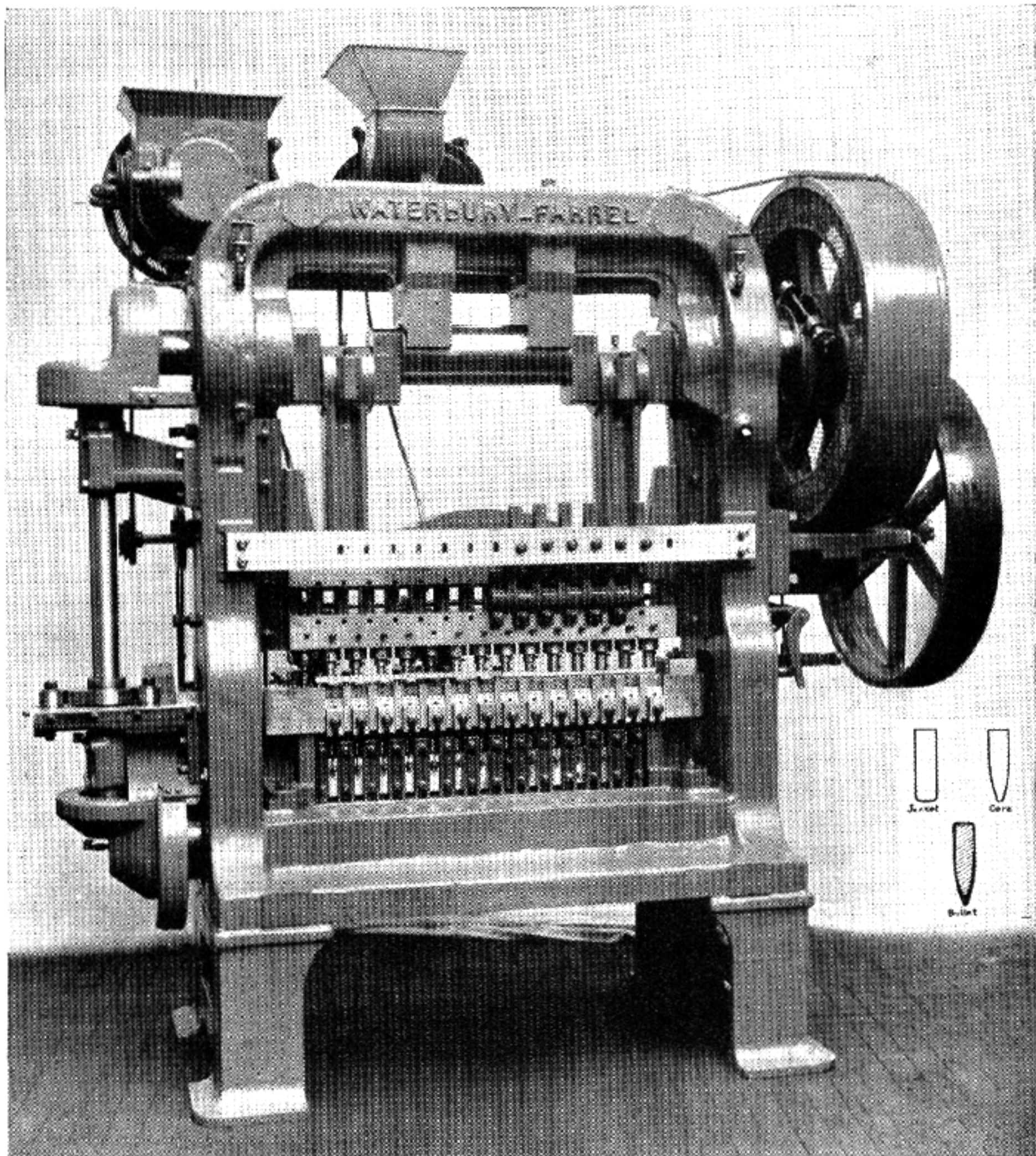

Fig. 171

Bullet-assembling press. This machine points the jacket, inserts the lead core, and forms the bullet, performing nine different operations before the bullet is complete. It is automatic in performance

High Velocity Bullets — Space is well taken to permit our following the advantages of the prevailing trend to high muzzle velocities and also guaranteed high remaining velocities at great distances. Naturally such results are sought by the experimenter as well as the army engineers of various military nations. High muzzle velocity means great striking energy with its finally instantaneous stopping power, whether on man or beast. High remaining velocities at distances insure one sight-setting, providing wind and weather are at rest; therefore the time of flight is reduced, which is also the object sought and a particular benefit in the process of moving troops or animals. This should inspire the experimenter to seek muzzle velocities up to 10,000 feet per second.

The highest velocity reached with our present arms and cartridges is approximately 3600 f.s. muzzle velocity with a Western Tool & Copper Company 120-grain bullet fired from a 300-caliber magnum rifle. The disadvantage of so high a velocity will often offset the advantage—due to high breech pressures, recoil, and decreased life of the barrel.

The caliber .30 Model 1906 cartridge has become standardized to about 2700 f.s. with a bullet weighing between 150 and 180 grains, which is about the highest practicable velocity, considering all factors involved, such as recoil, life of barrel, powder flash, etc. There can be slight changes made in powders, primers, and specially designed bullets, enabling these figures to be increased, for example, as much as 12 per cent; for our present-day demands a greater increase in velocity is not required, but we should never lose sight of the future or cease experimenting to meet its demands. Considerable study has been given this subject and German engineers have worked out methods of increasing the muzzle velocity by means which do not follow the present practise.

The scope and possibilities of the development of a high velocity over our present standards cannot be limited to the present new era in ballistics. To approach high velocities up to 10,000 f.s. with any bullet we must construct sub-caliber chambers and bullets designed small in caliber from the standpoint of interior ballistics; therefore it is desirable to have a bullet with as little mass as possible, but with considerable cross-sectional area and with low sectional density, the latter section so constructed as to give the powder gases sufficient area upon which to force the mass forward. This would mean a base made of a material 0.3 inch in diameter but capable of reducing itself as it passes up the bore, which is made on a taper until it reaches the rifled bore to a diameter of 0.15 inch, there to give the

projectile the desired rotation. As soon as the bullet takes flight the base will be useless, but the missile will speed on, capable of exceedingly high velocity because of its small cross-sectional area and large sectional density. The construction of such a bullet may be of steel given a cupro-nickel or silver plating heavy enough to take the rifling. Perhaps some authority will prove by theory that even these designs are impossible and contradictory to all laws of mechanics, but I shall assure him that they are based on the laws of the stars that we gaze upon, and can be done.

Mr. H. Gerlich, a German engineer, has many patents on ultra-high-velocity rifles and bullets, based upon extensive research work. This idea is only in its experimental stages, and by working out the correct details a 100-per-cent success could be obtained for military purposes as well as the possibilities on game. Facts are always stranger than theory, and we must lay theory aside and work up well established facts. I do not hesitate to say that the military nation that adopts the high-velocity bullet will be the ruling power of the world from a military aspect.

Designs of the Future — We cannot, however, take leave of past designs when they have only dipped over the horizon of a few hundred years. We have witnessed a gradual cycle of evolution. Wars have hastened the requirements for both arms and ammunition; still, many years have elapsed between radical changes. Our age has a temporal outlook. Let us with a glance see as far as we can.

It cannot be denied that our small-arms development is in a slow state of evolution. We take it, then, as proved, that the government arsenals must come to the fore, to design the necessary weapons and ammunition for war purposes, while private manufacturers follow the demands of the public. It is a real tragedy that game is disappearing, and that the rabbit and the fox may soon be the only animals man can test his skill on—that the larger animals will be but a memory recorded in our museums and game reservations. That "helpless" creature, man, will stamp out nature's gift, the wild animals, in the various parts of the world. A fresh tide of culture may change the whole course of life with a revived intellectual movement to stop all wars, but that time is very difficult to foresee; certainly it must be preceded by the elimination of the feeble-minded and criminal classes. Man seems to move in a series of cycles, advancing as he may, only to be interrupted by some closed circle of natural sequence, and then entering upon a larger, if less immediately satisfying process.

Probably there will be a development of the

ultra-high-velocity cartridges, as well as the rifles for fine target work; but a number of years will elapse before these can even become a standard among target shots; the government must first develop such arms in our arsenals to a high degree of accuracy, and both the arms and the ammunition must become reasonable in price. Meanwhile, certain cager minds will go on experimenting on them, regardless of cost.

Now, a glance into the far future. First, laws are going to restrict the civilian to such a point that to own firearms of any kind will be a crime punishable by law, due to the gradual tread of the crushing effect of the ruling classes over the masses. Secondly, wars will be unnecessary, by reason of disarmament agreements. Without a doubt these statements are a possibility. Many will say it is a ruinous possibility, for at last we shall have robbed men of their old fighting spirit. It then will be the extortioner who will unbalance it all. The pity of it is that men today are not educated upon the old lines, due to the small demand for high-class weapons for sporting purposes and protection. If we were living in an age that required weapons for self-protection, as in the early years of American colonization or in the ages when pre-historic monsters roamed the world, no one would say, "Let

the experimenter solve our problem of existence."

Consideration of the relative effectiveness of arms is at times peculiarly imperative; it must be so now. For the moment we are tired of our present-day lack of interest in firearms and their designs, and out of sympathy with all our present products. Merely wishing something different does not solve the problem. We must go on building from the experimental stages. We may have no clear vision to where we are going, but we cannot stand still, and it is for the man with the small experimental shop to carry out new ideas and designs and keep the fires lit continually. Man will always be thinking as his ships, motors, buildings and engines grow vaster or still increase in speed; and so will our bullets increase in velocity until we satisfy ourselves as to their possibilities.

In closing, it is necessary to emphasize the fact that no matter how perfect our design and manufacturing methods, they will in the end be wasted unless the cartridge case, rifle, barrel, and chamber be made aright, and the powders be correctly selected. Deep down remains the burning desire to increase velocity, accuracy, and striking energy; and in the end it will prevail. Intelligence is the medium of life's force and the will for others to guess.

CHAPTER XXIX

Mechanical Definitions and Phrases

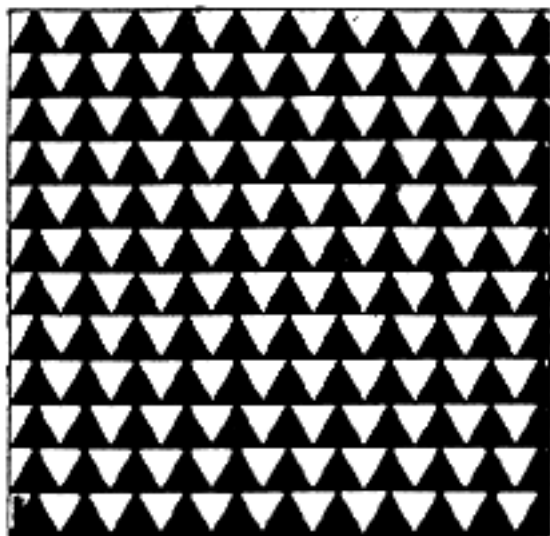

Mechanical Definitions and Phrases

THIS glossary has been compiled to assist our readers in definitely understanding the shop terms used by gunmakers in various parts of the country, as well as the names of their tools and appliances. This will eliminate any difficulty when we refer to any part of a rifle or shotgun. Old terms are included as well as modern ones.

To make this glossary complete would require a separate volume, for the field is large; but our space is limited, so we shall confine ourselves to the terms most frequently used. The names are in alphabetical order, with a description in language as simple as possible.

Action—That part to which the barrel is attached. In a rifle it is often called the receiver. Shotgun or double-barrel actions house all the mechanism or working parts. The term may be further modified as side-action, breech-action, bolt-action, snap-action, etc. It is also used to indicate the different forms of gun locks, as back-actions, front-actions, etc.

Adapter—An auxiliary chamber to fire smaller cartridges in a barrel of like caliber, but having a larger chamber. Adapters are made to conform to the outer walls of the chamber and reamed to fit the auxiliary cartridge.

Ammunition—All the various articles used in the discharge of firearms, such as cartridges, shells, powder, shot, bullets, primers.

Angle Plate—A cast-iron plate with two surfaces at right angles to each other.

Anneal—To render soft, as in the case of steel and other metals, by heating to a low red heat and allowing the article to cool gradually.

Aperture—An open passage. A rear sight with either a small or large opening; a peep sight.

Auxiliary Barrel—A rifled barrel that slips into a shotgun barrel, thus converting a shotgun temporarily into a rifle.

Auxiliary Chamber—See Adapter.

Back-action Lock—A gun-lock in which the main spring and sear are in the rear of the hammer or striker, all of the mechanism thus being in the wood of the stock.

Ball Reamer—Usually a fluted or rose reamer used for making bullet moulds. It is considered advisable to space the flutings in it irregularly, as this tends to prevent chattering.

Bar-action Lock—A lock that is bedded partly in the frame or action as well as in the stock. In a bar-action lock the main spring is ahead of the hammer or striker.

Barrel—The steel tube of a rifle or shotgun through which the projectile is given motion and is directed in its line of flight.

Barrel Band—A metallic loop fastened around the barrel to hold the barrel to the stock.

Bastard—Not regular. The term is usually applied to

a file, designating a size of tooth between the coarse and second cut; or to a screw thread, meaning one that is not of standard proportions.

Bend—The drop below the line of sight at the comb and heel of a shotgun or rifle butt-stock. This term is largely used by the British rifle and shotgun makers.

Bent—The notch in the tumbler of a shotgun lock.

Bevel—A tool for measuring or laying out angles. Also a surface not at right angles to the main surface. It may be of any angle. When two angles meet at 45 degrees it is called a "miter."

Binocular Vision—Sighting with both eyes open. The proper method of aiming a rifle, shotgun or pistol.

Bolt—A sliding bar used as a breech block in bolt-action rifles. The working part of the action that locks the cartridge in the chamber.

Bore—The interior of a barrel through which the charge passes. The rifle diameter over the lands. Bores or gauges of shotguns are based on the old-time method of fitting spherical bullets of fixed weight. For instance, an ounce bullet ran 16 to the pound, consequently the bore fitting an ounce spherical bullet was called 16 bore, and so on. Bores are made true-cylinder and also choked to give greater density of pattern at longer ranges. The bores of rifles have been made elliptical, hexagonal, polygonal, etc.

Brazing—The joining of metals by the use of copper filings or spelter. Borax or some other substance must be used as a flux.

Breech Pin—The plug with tang attached which is used on all muzzle-loading firearms.

Bridle—The inside plate in a shotgun lock, which supports the tumbler and other pins at their inside ends.

Broach—A tool which is practically a series of chisels or cutting teeth for enlarging holes or changing their shape. Generally used for odd-shaped holes. The round broach is used to enlarge and straighten the bore of a muzzle-loading rifle.

Browning—An oxidization produced and retained on the surface of gun barrels by means of acids. This is to prevent further oxidization or rust.

Bullet—A small projectile for a firearm made in various forms and weights. The base metal is always lead, alloyed with tin, antimony, etc., to give it resistance to the rifling. In modern high-velocity weapons the bullets are cased in an envelope of a harder metal. Bullets are made with full metal patch, hard nose, soft point or dum-dum, hollow point, and with bronze and steel points. Bullets used in warfare are full metal patch, when used against human beings; special forms are made for armor piercing, tracing, incendiary and other objects.

Bump—The corner or heel of the butt stock at the top of the butt plate.

Burnisher—A piece of highly polished and hardened steel, used in polishing the surface of metals.

Burnishing Reamer—A reamer used for finishing the bore and chamber of rifle barrels. The cutting edge comes to a sharp flat point in the center of the flute.

Butt—That part of a gunstock that fits against the shoulder.

Butt Plate—A plate of metal, horn, or vulcanite placed on the butt to protect the wood against damage.

Button—A steel bushing hardened and ground, made in sets and used to locate holes in jig plates and other work where it is necessary to have the bored holes correct distances apart.

Caliber—The diametrical measurement of the bore of a rifle barrel.

Caliper—An instrument used for measuring diameters. It is in different forms, such as outside, inside, keyhole, and slide calipers.

Cam—A rotating piece, eccentrically pivoted; placed in different parts of rifle and shotgun actions to give short locking motions. *Cam Effect*—Locking or moving with a cam.

Cannelure—A depression or narrow groove, either knurled or plain, rolled into the bullet or cartridge case. A cannelure in a bullet is often used for the purpose of crimping in the end of the cartridge case, thus holding the bullet at its proper depth. Other cannelures are designed to hold the lubricant.

Cap—The metal or other covering placed on a pistol grip and fore-end. Also the small cup-like primer placed on a nipple on muzzle-loading firearms to ignite the charge.

Carbonizing—The heat treatment of mild steel to make the outer surface hard. The surface absorbs carbon from the material used and forms a skin of glass-like hardness.

Carbine—A form of rifle made short enough to be easily carried on horseback.

Cartridge—The fixed ammunition for a firearm.

Case-hardening—A hardened steel-like exterior given to iron and cold-drawn steel by heating it in connection with cyanid or animal charcoal, and then plunging while hot into cold water.

Cast-off—The distance the stock is offset at the heel, to the right, from a straight line with the axis of the bore. It is called cast-on when to the left. For the right handed person it is to the right on all rifles and shotguns.

Center Fire—A form of cartridge case in which the primer is placed directly in the center of the base.

Center Punch—Punch for marking points on metal. It is often called a prick punch.

Chamber—The enlarged space or recess in the breech of a rifle or shotgun barrel wherein the cartridge is placed.

Charger—A measure employed for measuring powder in loading ammunition.

Chasers—Special tools used for cutting threads by chasing. Chasers are made circular and flat, and in the old days the flat ones were operated by hand.

Checker—Diamond shaped patterns incised in metal and wood for ornament, for matting the surface, and when used on the stock, to afford a more secure grip.

Cheek Piece—A projection on a part of the butt stock to afford a rest for the cheek at the time of firing.

Cherry—A small circular cutting tool used for forming the interior of bullet moulds. The term "cherry" was no doubt borrowed from the fruit of the same name.

Choke Bore—A shotgun bore slightly constricted at the muzzle.

Cleaning Rod—A rod used to clean a rifle or shotgun bore.

Clamp, C—A clamp shaped like the letter "C"—used for holding work in various ways.

Cock—In flint-lock guns, that part of the lock in which the flint was held. The name is also often applied to the hammer of percussion and other locks of more modern

make. When the hammer is pulled back to its last catch, we say the gun is full-cocked.

Cocking Piece—The projecting end of the striker extending back and free of the bolt in bolt-action rifles.

Comb—That part of the stock directly back of the "hand" upon which the cheek rests at the time of firing.

Cordite—A powder of a nitroglycerin base which comes in cords or strings like spaghetti. A high-velocity smokeless powder. The British use the word generally to denote smokeless powder.

Cross Bolt—A bolt frequently used on shotgun actions to lock the barrels to the standing breech.

Cross Hair—Minute cross wires designating the optical center of a telescope sight.

Crimping—Fluting, corrugating, or compressing the material, as at the end of paper shotgun shells and the ends of metallic cartridge cases, to crimp or hold the projectile in place.

Cut-off—A mechanical arrangement temporarily to cut off cartridges so they will not feed from the magazine into the chamber.

Cylinder—That part of the revolver in which the cartridges are held.

Damascus—A highly ornamental combination of metals, used in making shotguns during the last century. The guns were produced by twisting together dissimilar metal strips, such as steel and iron, and welding them. Damascus has been superseded by steel in these days, since suitable steel is homogeneous and weldless.

D. C. M.—Abbreviation for Director of Civilian Marksmanship. An officer of the War Department.

Dies—Tools used to cut, stamp, or form metal by pressure. Dies play a great part in all modern manufacturing, supplanting forging to a very great extent.

Dog—An old name for sear. Also a cocking lever. A trigger for each barrel of a double-barreled weapon.

Drop—Distance measured from the line of sight to the top of heel and comb of a gun stock.

Dutchman—A term used for a wedge or liner to make a close fit. With beginners a "dutchman" is often necessary to cover up mistakes and poor fits.

Ejector—An automatic device by which the fired shell is expelled from the chamber. *Automatic Ejector*—An automatic auxiliary lock which ejects the fired shell upon opening the breech of a shotgun.

Elevated Rib—The raised sighting plane placed on top of the barrels of a shotgun or rifle.

Escutcheon—A reinforcement of harder material through which a fastening passes.

Express Rifle—A term coined by Purdey, the eminent British gunmaker, to denote a rifle of greater velocity than customary. It was a black-powder term. The term *nitro express*, as now used, distinguishes a rifle of extreme power and velocity.

Extractor—An automatic spring-shaped hook, which draws the empty fired cases from the chamber.

Flash—In the old days of the flint-lock a gun was said to "flash" when the priming was ignited in the pan but failed to fire the charge. The flash hole in a cartridge case is the small hole between the primer pocket and the interior of a cartridge case. See Vent.

Flute—The name for the groove in reamers, taps, drills, etc. Its function is to relieve the cutting edge and carry the shavings.

Flux—A substance or mixture used to facilitate the amalgamation of metals or minerals when melting them. Glass, borax, etc., are fluxes.

Forearm—That portion of the stock lying under the

barrel, in front of the action. Also called the *fore-end*.

Forge—An open fireplace furnished with air blast for heating metals in welding, hardening, etc.

Fowling Piece—A term used in the old days for a light smooth-bore gun with which to hunt small game or "fowl."

Frizzen—In old flint-lock guns, the steel plate that receives the blow of the cock and covers the pan. It is also called the "hen."

Front Sight—The sight located nearest the muzzle of the barrel. The old name for this was "foresight."

Gauge or Gage—The term used for shotgun bore sizes. The standard gauges are 10, 12, 16, 20, 28, and 410.

German Silver—A useful alloy. It is copper 60 parts, zinc 20 parts, nickel 20 parts. The old gunsmiths used this metal largely for ornamentation.

Grip—A name usually applied to the "hand" of the butt-stock. It also applies to the grip of a revolver and pistol.

Guard—The loop of metal which curves around the trigger to protect it.

Hack-saw—A highly tempered saw for cutting metal, held in a hand frame or operated by power.

Hammer—That part of the gun lock which strikes the plunger.

Hammer Gun—A gun whose hammers are on the outside of the action.

Hammerless Gun—A gun whose hammers are concealed within.

Hand—The operating lever which turns the cylinder when the hammer is pulled back on a revolver. The "grip" of the butt stock.

Hang Fire—A delayed ignition. An uncommon circumstance in modern ammunition, but when it occurs a very dangerous one. When ignition is not instantaneous the breech should not be opened for several seconds.

Heel Plate—See butt plate.

Hinge Pin—The pin in the action of a shotgun upon which the barrel plays.

Ignition—Any chemical combination which can be caused to explode and fire the powder charge.

Kentucky Rifle—A pioneer American rifle. It was muzzle-loading and had a very small bore. The great length of the barrel was one of its main features. It marked one of the most important steps in the development of the rifle.

Kick—The recoil of a firearm at the moment of firing.

Knurling—The checkering or roughening of a metal surface to afford a better grip. It is used on windage and elevating screws, etc.

Lands—The spaces in the bore of a rifle barrel between the grooves. The spaces between the flutes or grooves in reamers, taps, etc.

Lap—A plug usually made of lead, iron, or copper, which, charged with abrasives, is used for fine grinding.

Lathe—The engine lathe is the ordinary form of this useful turning machine, with lead screw, power feed, slide-rest, etc.

Leaf Sight—A rear barrel sight with one or more folding leaves for various ranges.

Lever—The moving handle, the working of which locks or unlocks the action in guns or double rifles. There are several forms, such as top-lever, side-lever, under-lever, etc.

Lock Plate—The flat plate on the sides of shotgun or double-rifle actions upon which all the parts of the gun lock are built.

Lower Rib—The rib underneath and between the barrels of a shotgun or double rifle.

Lump—The projecting fin in the center breech end of the barrels of a shotgun or double rifle which descends into the flat of the bolt and forms the abutment into which the sliding bolt engages.

Main Spring—The large spring in the gun lock which imparts action and power to the hammer.

Magazine—The receptacle for the cartridges in a repeating weapon, from which they are fed automatically into the chamber by the action of the mechanism. A term also used in small-caliber bolt-action rifles.

Magazine Rifle—A rifle provided with a magazine for containing cartridges, and so made that, by means of springs or levers, the cartridges pass into the chamber ready for firing.

Magnum—Meaning very large or very great. A term used by the British rifle makers to denote a weapon of much more than normal power.

Master Die—A die made standard and used only for reference purposes or for making tools. The term "master" is used also for reference gauges, tools, etc.

Measurements—The standard measurements in firearms are the decimal parts of the inch and meter.

Milling Machine—A machine operating a stationary revolving cutter. The work is brought in contact with the cutter by a traversing table.

Miter—A bevel of 45 degrees.

Monocular Vision—Viewing with only one eye. When one eye is closed in taking sight with a gun, it is a case of monocular vision.

Monte Carlo—A form of butt stock in which the comb is carried back horizontally almost to the butt, when it descends abruptly to the heel portion. It is used to some extent in live-pigeon shooting.

Mould, Bullet—An implement for moulding bullets.

Mounts—A steel cradle which carries the telescope on a rifle. It is so designed that adjustments of the 'scope are freely made and the 'scope easily mounted and dismounted.

Musket—The military form of a rifle. The word is frequently used to designate the old smooth-bore military guns of a past period.

Muzzle—The exit end of a rifle or shotgun barrel.

Nipple—The short tube upon which the cap is placed in a percussion firearm.

Nipple Wrench—An implement used for screwing a nipple into position or out. It was often called a tube wrench.

Nose—In shop work this term is applied to the business end of a circular pointed lathe tool, or the threaded end of a lathe or milling-machine spindle.

N. R. A.—Abbreviation of National Rifle Association. A government organization for the promotion of rifle practice.

Offset—See Cast-off.

Over and Under—A gun or rifle in which the barrels are placed vertically, one over the other. This perhaps is the most logical and up-to-date system of firearm construction.

Paradox—A shotgun with a portion of the barrel at the muzzle rifled. It will, by this means, fire heavy lead bullets, and at the same time handle a shot charge equal to a modified bored shotgun. Very popular in India and Africa.

Pan—The small pan or receptacle on the flint-lock action which holds the priming charge and in which the latter is ignited by a spark from the flint striking the frizzen.

Pepper-box Pistol—A form of revolving pistol in which

the barrels are made full length from one piece of metal. The rotation of the barrels and the action of the lock was produced by the pulling of the trigger. It antedated the revolver, but is now obsolete.

Percussion—A compound of various elements used as a detonating or explosive agency, such as the percussion cap used on rifles from 1830 onward and the primer now an essential part of rim- and center-fire cartridges. The percussion primer is also used in fuses.

Picker—A small wire implement of the days of the old flintlock and used when occasion required to relieve or clean the touch-hole of the barrel.

Pipes—Short tubular receptacles attached to the under side of a barrel to hold the ramrod in place.

Pistol—A small variety of firearm so made as to be easily carried in the pocket and fired with one hand. A hand-gun.

Pistol Grip—A gun stock the grip of which turns down, as does the handle of a pistol.

Pitch—The distance from the center of one screw thread, or gear tooth, or serration of any kind, to the center of the next. In screws with single threads the pitch is the same as the lead, but not otherwise. The angle which the butt of a firearm takes in relation to the line of sight.

Planishing—The finishing of sheet metal by hammering with a smooth-faced hammer.

Plungers—The firing pins which are struck by the hammers in shotguns and double rifles. Called strikers in bolt-action rifles.

Powder Bed—The chamber in a muzzle-loading rifle.

Priming—The powder in the pan of a flint-lock gun.

Proof Marks—Impressions of stamps made on shotgun and rifle barrels to indicate that they have been proved.

Proving—Testing gun barrels with a 30 to 40 per cent overcharge to ascertain if the barrels and actions are of the requisite strength.

Ramp—A slope or incline. The sloping part of a front-sight base on a rifle.

Ramrod—The rod with which the charge is pushed home in loading the old muzzle loader. The term is still often used for a cleaning rod.

Reamer—A tool to enlarge a hole already existing. Reamers are of many kinds and shapes.

Rebounding Lock—A lock in which the top of the main spring and the crank of the tumbler are so lengthened that when the trigger is pulled the hammer delivers its blow and immediately rebounds to its safety position. It automatically takes the place of the old half-cock.

Recess—A groove beyond the normal surface of the work, such as a recess bored inside of a cylinder. This is often called the counterbored part. An illustration is the recess made to receive the head of a shell.

Relief—The removing of, or the amount removed from, a tool to reduce friction, as back of the cutting edge of a reamer, drill tap, etc.

Revolver—A repeating firearm with a revolving cylinder, carrying the cartridges.

Rib—The strip of metal lying between and connecting the barrels of shotguns and double rifles. (See lower and upper rib.)

Riffle—The name given a small curved file used by die sinkers and others who do similar work.

Rifle—A gun with grooves cut in a twisted or spiral manner upon the interior of the barrel for the purpose of giving the projectile a rotary motion on its axis during

flight. This keeps the center of gravity constant and gives infinitely greater accuracy to the course of the bullet.

Rifling Guide—An attachment used by the old-time gunsmiths to guide the course of the rifling saw in cutting the spiral grooves in the bore of a rifle barrel.

Rifle Saws—Short files made to cut the grooves of a rifle by the old-time method of rifling a barrel. They were attached to a rod near its end, and drawn back and forth through the barrel for the purpose of filing the worn groove down to a greater depth. In cases where new grooves were to be cut in a new barrel, the rod passed through a rifle guide, which forced the saws to take the proper spiral through the barrel.

Rim Fire—A cartridge in which the priming mixture is placed in the fold of the head of the shell; in distinction from center fire, in which the priming mixture is contained in a primer imbedded in the center of the cartridge head. The popular .22-caliber ammunition is the best illustration of the rim-fire method.

Rook—A European bird of the crow family. A small-bore rifle used by the British to shoot crows and other vermin.

Rouge—A fine abrasive paste or powder used for putting a high polish upon the surface of well-finished metals. It is usually applied by rubbing with a soft leather pad, but can be applied by buffing wheel or otherwise.

Run—The term applied to a drill or reamer when the tool shows a tendency to diverge from the straight or direct path intended.

Saw—See Hack-saw.

Scatter—A term applied to a shotgun which throws the shot over an unusually wide range of space. It is said to "scatter."

Scroll Guard—An extension downward from the trigger guard or an extra-long guard used to improve the grip on match rifles. Also the fancy brass trigger guards on muzzle-loading rifles.

Sear—That part which engages in the bend of the cocking piece. Sometimes a part of the trigger. The firing mechanism of a rifle. On a shotgun the sear is separate from the trigger.

Sear Spring—The small spring used to hold the sear to its position.

Set Trigger—A device for lightening the trigger pull at will, in order to remove the disturbing effect of a heavy pull in target shooting. It is usually effected by means of a series of levers which distribute the force required. The commonest and simplest example takes the form of a pair of triggers, the rear one being used to bring the sear to almost the firing position. A touch on the front trigger completes the movement and the arm is discharged. Set triggers are chiefly associated with the Schützen Verein.

Shaper—A machine where the work is held in a vise on a table or knee and the tool moves horizontally across it. A small metal planer.

Shim—A liner or thin piece of material used for placing between surfaces to secure proper adjustment.

Side Screw (Side Pin)—The long screw extending through the stock of a side-lock gun to secure the locks to the frame and stock.

Sling—A leather or heavy canvas strap used either to carry a rifle or to assist in steady holding of a rifle in deliberate shooting.

Schnabel—The tip of the forearm when it is made in pointed or ornamental form—named from the German word for a bird's beak.

Spinning—The forming of sheet metal by stretching and compressing as it revolves in a lathe.

Spring Compression—A helical spring which shortens in action.

Spring, Helical—A spring coiled lengthwise of its axis like a screw thread. Often incorrectly called a spiral spring.

Spring, Spiral—A spring wound with one coil over the other as in a clock spring. Usually of flat section, but not necessarily.

Square—An angle of 90 degrees or the fourth part of a circle.

Square, Combination—A handy combination tool consisting of square, bevel, and protractor in one.

Steady Pin—The small pin or projection of a main spring which fits in the lock plate.

Strap—The posterior elongation of the frame of a shotgun or double-rifle action which runs down into the stock and provides its principal attachment.

Strikers—See Plungers.

Sweating—A form of soldering.

Swivel—The small piece in a shotgun lock connecting the tumbler and main spring. In revolvers it is used to connect the spring and the hammer. The oblong loop used to connect the sling strap to the barrel and stock of a rifle is called *swivel bow*.

Tenon—A projecting dowel engaging in a corresponding hole. It is used to intimately locate and reinforce tenonable attachments.

Thimble—The metallic loop on the under side of the old muzzle-loading shotguns and rifles to hold the ramrod.

Toe—The extremity of the stock which rests nearest the armpit.

Top Lever—The lever of a shotgun or double rifle

placed on the upper surface of the action, which works the opening and locking mechanism of the gun.

Trammels—Heads of beam compasses for drawing large circles. These fit on a beam of either steel or wood and can be adjusted to any diameter.

Trigger—Called "tricker" by old gunsmiths because it did the trick. The small finger lever under the gun, which when pressed with the finger releases the confined main spring and allows the hammer to descend.

Trigger (Single)—A trigger so devised that it will discharge both barrels of a double gun.

Trigger Plate—The steel plate upon which the triggers are pivoted.

Tube—The term used for a rifle or shotgun barrel in the rough. Often referred to colloquially as "the rifled tube." An old name for nipple.

Tumbler—The hammer, so called, of a hammerless gun.

Upper Rib—The rib above and between the barrels of a double-barreled shotgun or rifle.

Vent—A small hole between the primer pocket and powder chamber in a cartridge case. Also the small hole in the side of old flint-lock guns, communicating with the interior of the powder chamber.

Vise—An implement for clamping or holding work during operations.

Windage—A term used for sight correction laterally either right or left. As its name implies, it is to make adjustments for wind pressure.

Wiper—A shop ramrod used in wiping out and cleaning the bore of firearms. Also a small spiral implement made to attach on the end of a ramrod for the purpose of boring into and drawing a wad from a gun.

DIRECTORY
Gunsmithing Supplies,
Gun Makers, and
Gunsmiths

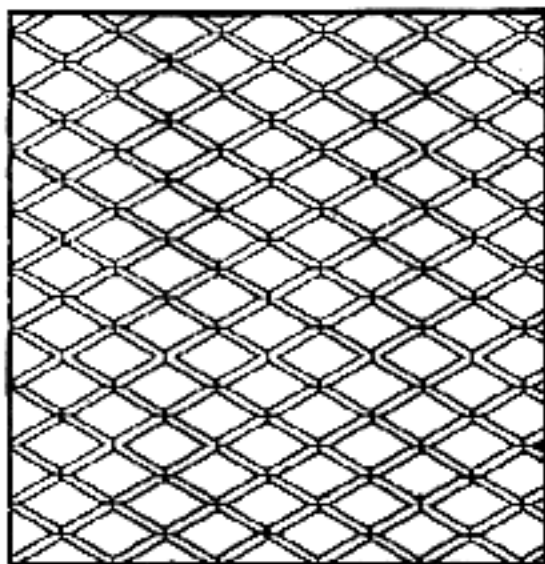

DIRECTORY

Gunsmithing Supplies, Gun Makers, and Gunsmiths

* * *

Ammunition Manufacturers:

Peters Cartridge Division,
Bridgeport 2, Conn.
Remington Arms Co., Inc.,
Bridgeport 2, Conn.
U.S. Cartridge Co.,
111 Broadway,
New York 6, N. Y.
Western Cartridge Co.,
(Division of Olin Industries, Inc.)
East Alton, Ill.
Winchester Repeating Arms Co.,
(Division of Olin Industries, Inc.)
New Haven 4, Conn.
Imperial Chemical Industries, Ltd.,
Witton, Birmingham, England.
Berlin-Karlsruher Industrie-Werke AG,
Karlsruher, Baden, Germany.

Antique Firearms:

Francis Bannerman Sons,
501 Broadway,
New York 12, N. Y.
Kimball Arms Co.,
Woburn, Mass.

Arms and Ammunition Dealers:

Abercrombie & Fitch Co.,
342 Madison Ave.,
New York 17, N. Y.
Charles A. Bogert,
144 Jackson St.,
Sandusky, Ohio.
Hudson Sporting Goods Co.,
52 Warren St.,
New York 7, N. Y.
S. E. Laszlo,
(Eley Shotgun shells)
25 Lafayette St.,
Brooklyn 1, N. Y.
Philip Jay Medicus,
18 Fletcher Place,
New York 57, N. Y.
Stoeger Arms Corp.,
45-47 Pearson St.,
Long Island City 1, N. Y.
Von Lengerke & Antoine,
9 North Wabash Ave.,
Chicago 2, Ill.
Westley Richards & Co., Ltd.,
23 Conduit St.,
London, W. 1, England.

Barrel Drills and Barrel Tools:

Forster Brothers,
86 E. Lanark Ave.,
Lanark, Ill.
Fuller Tool Co.,
4000 West Eleven Mile Road,
Berkley, Mich.
H & M Tool Co.,
24062 Orchard Lake Road,
Farmington, Mich.
High Standard Manufacturing Co.,
(Barrel Drills & Tubes)
Dixwell Ave.,
Hamden, Conn.
Pratt & Whitney Co.,
(Rifling Heads, etc.)
Hartford, Conn.
Redford Reamer Co.,
Box 141, Redford Station,
Detroit 19, Mich.
L. E. Wilson,
Box 636,
Cashmere, Wash.

Binoculars:

Bausch & Lomb Optical Co.,
630 Lomb Park,
Rochester 2, N. Y.
D. P. Bushnell & Co.,
43 E. Green,
Pasadena 1, Calif.
Far Eastern Sales Co.,
2251 W. Pico,
Los Angeles 6, Calif.
National Camera Exchange,
86 South 6th St.,
Minneapolis 2, Minn.
United Binocular Co.,
9043 S. Western Ave.,
Chicago 20, Ill.
Carl Zeiss, Inc.,
485 Fifth Ave.,
New York 17, N. Y.

Bluing Barrels and Gun Parts:

Paul Jaeger,
Jenkintown, Pa.
Ken's Polishing Shop,
7 South First St.,
Minneapolis 1, Minn.
Midland Munitions Co.,
P.O. Box 481,
Bloomington, Ill.

Protective Coatings, Inc.,
Box 3985,
Detroit 27, Mich.

Remington Arms Co.,
Ilion, N. Y.

J. A. Wingert,
124 W. 2nd St.,
Waynesboro, Pa.

Checkering and Inletting Tools:

W. E. Brownell,
925 Donmeyer Ave.,
South Bend 14, Ind.

Frauz Metal Specialties,
625 N. 22nd St.,
Allentown, Pa.

Hagen Engineering,
5211 S. Monitor,
Chicago 38, Ill.

Schmidt Precision Products,
Rt. 1, Box 150M,
Saugus, Calif.

Stoeger Arms Corp.,
45-47 Pearson St.,
Long Island City 1, N. Y.

Warner Products,
Baldwinsville 1, N. Y.

Chemicals:

J. T. Baker Chemical Co.,
Phillipsburg, N. J.

McKesson Hall-Van Gorder Co.,
1382 West 9th St.,
Cleveland 13, Ohio.

Cleaning Oils and Solvents:

Brownell Industries,
Montezuma, Iowa.

J. A. Gaines Co.,
1910-A Harris Ave.,
Anniston, Ala.

Frank A. Hoppe, Inc.,
2321 N. 8th St.,
Philadelphia 33, Pa.

Mitchell Chemical Co.,
Stratford, Conn.

Outers Laboratories, Inc.,
Onalaska, Wis.

Winchester Repeating Arms Co.,
New Haven 4, Conn.

A. G. Parker & Co., Ltd.,
Birmingham, England.

Westley Richards & Co., Ltd.,
Birmingham, England.

Gun Barrels:

Ashton & Co.,
1511 N. Gardner St.,
Los Angeles 46, Calif.

J. R. Buhmiller,
P.O. Box 381,
Kalispell, Mont.

Custom Gunsmith Service,
7670 San Fernando Road,
Sun Valley, Calif.

Easton Engineering Co.,
1554 South 2nd West,
Salt Lake City 10, Utah.

G. R. Gouglas,
Rt. 3, Box 297A,
Charleston, W. Va.

Johnson Automatics Arms Co.,
P.O. Box 1512,
Providence 1, R. I.

Pfeifer Rifle Co., Inc.,
11252 Pen Rose St.,
Sun Valley, Calif.

Ralph F. Pride,
P.O. Box 5154,
Portland 16, Ore.

Weatherby's, Inc.,
2781 Firestone Blvd.,
South Gate, Calif.

Gun Barrel Steels:

Crucible Steel Co. of America,
405 Lexington Ave.,
New York 17, N. Y.

Midvale Steel Co.,
Philadelphia, Pa.

Timken Roller Bearing Co.,
Canton, Ohio.

Firth Sterling Steel Co.,
Sheffield, England.

Gun Barrels Chrome-plated:

Marker Machine Co.,
P.O. Box 426,
Charleston, Ill.

Gun Barrels Relined:

Thomas Diller,
P.O. Box 531,
Dayton 1, Ohio.

Gun Barrel Machinery:

Pratt & Whitney Co.,
Hartford, Conn.

Gun Engraving:

Calwell,
3014 Parkway Terrace,
Washington 20, D. C.

A. Griebel,
4724 N. Keystone Ave.,
Chicago 30, Ill.

Gathol E. Windsor,
1113 McGee St.,
Kansas City 6, Mo.

Gunmaker's Supplies:

Maynard Buchler,
Orinda, Calif.

C. Dana Cahoon,
Topsfield Road,
Boxford, Mass.

William Dixon, Inc.,
32 E. Kinney St.,
Newark 2, N. J.

Frank S. Fitchett,
232 Fowler Ave.,
San Francisco 16, Calif.

E. C. Grace,
Horton, Mich.

Heat Bath Corp.,
Springfield 1, Mass.

Paul Jaeger,
Jenkintown, Pa.

Phil Judd,
83 E. Park St.,
Butte, Mont.

Frank Mittermeir,
3577 E. Tremont Ave.,
New York 6, N. Y.

Numrich Arms Co.,
Mamaroneck, N. Y.

C. R. Pederson & Son,
Ludington, Mich.

The Redding Co.,
Cortland 2, N. Y.

Schmidt Precision Products,
Rt. 1, Box 150M,
Saugus, Calif.

Schrader Instrument Co.,
Independence 3, Iowa.

Stoeger Arms Corp.,
45-47 Pearson St.,
Long Island City 1, N. Y.

Mitchel Bosley,
75 Bath St.,
Birmingham, England.

Gun Repair Parts, Etc.:

Francis Bannerman Sons,
501 Broadway,
New York 12, N. Y.

Christy Gun Works,
Sacramento 16, Calif.

Hudson Sporting Goods Co.,
52 Warren St.,
New York 7, N. Y.

Molnar Engineering Co.,
Bairdord, Pa.

Charles W. Moore,
Delhi, N. Y.

The Poly-Choke Co.,
571 Tunxis St.,
Hartford 1, Conn.

Stoeger Arms Co.,
45-47 Pearson St.,
Long Island City 1, N. Y.

Lightwood & Son,
Price St.,
Birmingham, England.

Standard Sporting Guns, Ltd.,
20-21 Bath St.,
Birmingham, England.

Gun Slings:

The Herman H. Heiser Co.,
Denver 4, Colo.

Sporty Sling Co.,
990 East Slauson,
Los Angeles 11, Calif.

Gunsmiths:

J. A. Bibey,
122 S. Lincoln,
Roseville, Calif.

Cougar Arms Co.,
141 Michigan St., N. E.,
Grand Rapids 3, Mich.

Custom Gunsmith Service,
7670 San Fernando Road,
Sun Valley, Calif.

Fryer's Gun Shop,
209 Whittier St.,
Vandergrift, Pa.

Roy Gradle,
205 West Islay,
Santa Barbara, Calif.

Griffin & Howe, Inc.,
202 East 44th St.,
New York 17, N. Y.

Kenneth L. Hooper,
Box 911,
Eureka, Mont.

Paul Jaeger,
Jenkintown, Pa.

Kimball Arms Co.,
Woburn, Mass.

R. W. Lathrop,
110½ Broadway,
North Seattle 2, Wash.

Laurence Naumann,
Douglas, Wyo.

Nelsen's,
1932 E. 4th,
Olympia, Wash.

Thurman Randle & Co.,
208 N. Akard St.,
Dallas 1, Tex.

Gart Sloan,
1022 West Slauson Ave.,
Los Angeles 44, Calif.

L. R. Wallack,
Mayfield, N. Y.

J. A. Wingert,
124 W. 2nd St.,
Waynesboro, Pa.

Wurzer & Peterson,
5239 North Fifth St.,
Philadelphia 20, Pa.

Gunstock Blanks:

Banks-Maxwell,
Box 3301A,
Fort Worth 5, Tex.

Flaig's,
Millvale, Pa.

Roberts Myrtle Wood Shop,
14702 N. E. Sandy Blvd.,
Portland 20, Ore.

D. W. Thomas,
Box 184,
Vineland, N. J.

Mitchel Bosley,
75 Bath St.,
Birmingham, England.

Hand and Machine Tools:

General Aire Co.,
447 W. Norris St.,
Philadelphia 22, Pa.

Hammacher, Schlemmer & Co.,
145 E. 57th St.,
New York 22, N. Y.

Schupack Supply Co.,
7331 Cottage Grove Ave.,
Chicago 19, Ill.

Stanley Tools,
101 Elm St.,
New Britain, Conn.

Stoeger Arms Corp.,
45-47 Pearson St.,
Long Island City 1, N. Y.

Hand-loaded Ammunition:

Brooks Cartridge Reloading,
488B Cherry St.,
San Bruno, Calif.

Hanson's Custom Loading,
Box 143,
Bonner Springs, Kan.

J. W. McPhillips,
285 Mastick,
San Bruno, Calif.

Inletted Gunstocks:

Banks-Maxwell,
Box 3301A,
Fort Worth 5, Tex.

E. C. Bishop & Son, Inc.,
Warsaw, Mo.

Central Pattern Works, Inc.,
1338 Clark St.,
Racine, Wis.

Flaig's,
Millvale, Pa.

Robert K. Haelig,
(Shotgun stocks)
Bound Brook, N. J.

Herter's, Inc.,
Waseca, Minn.

Leather Goods—Gun Cases, Etc.:

The Boyt Co.,
Des Moines, Iowa.

J. M. Bucheimer Co.,
Towson 4, Md.

Can-Pro Corp.,
Fond du Lac, Wis.

Bradley E. Grimes Co.,
West Collingswood Heights, N. J.

The Herman H. Heiser Co.,
Denver 4, Colo.

The Hood Co.,
(Rust-Pruf Pouches)
11048 S. Van Ness,
Los Angeles 47, Calif.

George L. Jensen,
(Cartridge cases)
4100 W. 49th Ave.,
Denver 12, Colo.

S. D. Myres Saddle Co.,
El Paso, Tex.

Nichols Sporting Goods,
Yarmouth, Me.

Sterns Manufacturing Co.,
St. Cloud, Minn.

Tandy Leather Co.,
P.O. Box 791-AA,
Fort Worth 1, Tex.

Linseed and Sperm Oils:

McKesson Hall-Van Gorder Co.,
1382 W. 9th St.,
Cleveland 13, Ohio.

Muth Brothers,
Baltimore, Md.

Metalworking Tools:

Pratt & Whitney Co.,
Hartford, Conn.

Sheldon Machine Co., Inc.,
4243 N. Knox Ave.,
Chicago 41, Ill.

South Bend Lathe,
South Bend, Ind.

Recoil Pads:

Dayton-Traister Co.,
34 S. E. 66th Ave.,
Portland 16, Ore.

Hawkins Recoil Pad Co.,
Sioux City, Iowa.

Jostem Manufacturing Co.,
5252 Broadway,
Chicago 40, Ill.

Mershon Co., Inc.
Glendale, Calif.

Public Sports Shop,
11 S. 16th St.,
Philadelphia 2, Pa.

A. G. Parker & Co., Ltd.,
Birmingham, England.

Reloading Tools:

Belding & Mull,
9 N. Front St.,
Philipsburg, Pa.

Cramer Bullet Mould Co.,
11625 Vanowen St.,
North Hollywood, Calif.

Easton Engineering Co.,
1554 S. 2nd, West,
Salt Lake City 10, Utah.

Foster Brothers,
86 E. Lanark Ave.,
Lanark, Ill.

Hollywood Gun Shop,
6116 Hollywood Blvd.,
Hollywood 28, Calif.

J. S. Hulme,
140 Miriam St.,
Daly City 25, Calif.

Johnson's Rifle Clinic,
202 N. Chaparral St.,
Corpus Christi, Tex.

The Lyman Gun Sight Corp.,
Middlefield, Conn.

Pacific Gun Sight Co.,
2901 El Camino Real,
Palo Alto, Calif.

G. T. Smily Co.,
Clipper Gap, Calif.

Reloading Supplies:

Alcan Co., Inc.,
Alton, Ill.

Aurand's,
229-31 E. 3rd St.,
Lewiston, Pa.

Carbide Die & Manufacturing Co.,
600 E. Evergreen St.,
Monrovia, Calif.

The Gun Shop,
3718 Broadway,
Chicago 13, Ill.

B. E. Hodgdon,
Merriam, Kan.

Kerr's,
9582 Wilshire Blvd.,
Beverly Hills, Calif.

Lindahl Gun Co.,
Central City, Neb.

Precision Tool & Gun Co.,
303 E. Upland Road,
Ithaca, N. Y.

Rochester Lead Works,
Rochester 8, N. Y.

Robert S. Thomas,
8402 Fenton St.,
Silver Springs, Md.

Warner & Sons,
(Gas Checks)
2510 Pleasant Valley,
Altoona, Pa.

Revolver and Automatic Finger Grips:

Harvey E. Henshaw,
818-20 Oakwood St.,
Pittsburgh 21, Pa.

Frank Mittermeir,
3577 E. Tremont Ave.,
New York 61, N. Y.

Pachmayr Gun Works,
1220 S. Grand Ave.,
Los Angeles 15, Calif.

Bob Winger,
717 Broad St.,
Montoursville, Pa.

Revolvers and Automatic Pistols:

Colt's Patent Fire Arms Manufacturing Co.,
Hartford 15, Conn.

Harrington & Richardson Arms Co.,
Worcester, Mass.

High Standard Manufacturing Corp.,
Dixwell Ave.,
Hamden, Conn.

Iver Johnson's Arms Co.,
Fitchburg, Mass.

Smith & Wesson,
Springfield, Mass.

Strum, Ruger & Co., Inc.,
Southport, Conn.

Webley & Scott, Ltd.,
Birmingham, England.

Rifle and Shotgun Manufacturers:

Browning Arms Co.,
St. Louis 3, Mo.

The Hunter Arms Co.,
(L. C. Smith shotguns)
Fulton, N. Y.

Ithaca Gun Co., Inc.,
Ithaca, N. Y.

Johnson Automatics Arms Co.,
P.O. Box 1512,
Providence 1, R. I.

Marlin Firearms Co.,
New Haven, Conn.

O. F. Mossberg & Sons, Inc.,
12511 St. John St.,
New Haven 5, Conn.

Parker Brothers,
Meriden, Conn.

Savage Arms Corp.,
Utica, N. Y.

J. Stevens Arms Co.,
Chicopee Falls, Mass.

Winchester Repeating Arms Co.,
(Division of Olin Industries, Inc.)
New Haven 4, Conn.

Francotte Arms Co.,
Liège, Belgium.

Birmingham Small Arms Co., Ltd.,
Birmingham, England.

Boss & Co.,
41 Albemarle St.,
London, W. 1, England.

Robert Churchill,
Orange St., Leicester Square,
London, England.

Cogswell & Harrison, Ltd.,
168 Piccadilly,
London, England.

Stephen Grant,
7 Bury St., St. James,
London, S.W. 1, England.

W. W. Greener,
St. Mary's Row,
Birmingham, England.

Holland & Holland, Ltd.,
98 New Bond St.,
London, W. 1, England.

W. J. Jeffry & Co., Ltd.,
26 Bury St., St. James,
London, S.W. 1, England.

Thomas Powell,
Birmingham, England.

John Rigby & Co.,
43 Sackville St.,
London, S.W. 1, England.

Vickers Limited,
Crayford, Kent, England.

Webley & Scott, Ltd.,
Birmingham, England.

Westley Richards & Co., Ltd.,
(Works at Birmingham)
23 Conduit St.,
London, W. 1, England.

James Woodward Sons,
64 St. James's St., Pall Mall,
London, S.W. 1, England.

Gustav Genschow & Co., Ltd.,
Sudseehaus,
Hamburg 1, Germany.

Heinrich Krieghoff,
Suhl, Germany.

J. P. Sauer & Co.,
Suhl, Germany.

Husqvara Vapenfabriks Aktiebolg,
Husqvara, Sweden.

Riflemen's Supplies:

Brownell Industries, Inc.
Montezuma, Iowa.

Detroit Bullet Trap Co.,
8600 Lyndon,
Detroit 21, Mich.

Al Freeland,
3737 Fourteenth Ave.,
Rock Island, Ill.

Gopher Shooter's Supply,
Faribault, Minn.

G.R.C. Manufacturing Co.,
Olean, N. Y.

P. J. O'Hare,
552 Irvington Ave.,
Maplewood, N. J.

Palley Supply Co.,
6321 Fernando Road,
Glendale 1, Calif.

Thurman Randle & Co.,
208 N. Akard St.,
Dallas 1, Tex.

10-X Manufacturing Co.,
405 E. 2nd St.,
Des Moines 9, Iowa.

Norm Thompson,
5095 S. W. Barnes Road,
Portland 1, Ore.

Rifle Powders:

E. I. Du Pont De Nemours & Co.,
Wilmington, Del.

Hercules Powder Co.,
Wilmington, Del.

Kings Powder Co.,
(Black powders)
Kings Mills, Ohio.

Olin Industries, Inc.
East Alton, Ill.

Sporting Arms & Ammunition Institute,
343 Lexington Ave.,
New York 16, N. Y.

Rifle Telescopes and Mounts:

Bausch & Lomb Optical Co.,
643 Lomb Park,
Rochester 2, N. Y.

J. W. Fecker, Inc.,
2016 Perrysville Ave.,
Pittsburgh 14, Pa.

Griffin & Howe, Inc.,
202 E. 44th St.,
New York 17, N. Y.

T. K. Lee,
(Lee Dot Reticule)
P.O. Box 2123,
Birmingham 1, Ala.

E. W. Lehman,
P.O. Box 326, Hillcrest Station,
San Diego 3, Calif.

Leupold & Stevens Instruments, Inc.,
Portland 13, Ore.

R. A. Litchert,
Winchester, Ind.

The Lyman Gunsight Corp.,
Middlefield, Conn.

The Montana Mount,
Box 311,
Livingston, Mont.

Pachmayr Gun Works,
1220 S. Grand Ave.,
Los Angeles 15, Calif.

Stith,
500 Transit Tower,
San Antonio 5, Tex.

Tinsley Laboratories,
2524 Grove St.,
Berkeley 4, Calif.

John Unertl Optical Co.,
355-55 East St.,
Pittsburgh 14, Pa.

W. R. Weaver Co.,
El Pasco, Tex.

Carl Zeiss, Ind.,
(Hensoldt Hunting Scopes)
485 Fifth Ave.,
New York 17, N. Y.

Shooting Spectacles:

Bausch & Lomb Optical Co.,
643 Lomb Park,
Rochester 2, N. Y.

Belz, Opticians,
2 E. 44th St.,
New York 17, N. Y.

Sights:

King Gun Sight Co.,
667 Howard St.,
San Francisco 5, Calif.

The Lyman Gunsight Corp.,
Middlefield, Conn.

Marble Arms & Manufacturing Co.,
502 Delta Ave.,
Gladstone, Mich.

Merit Gunsight Co.,
6144 Monadnock Way,
Oakland 5, Calif.

Micro Sight Co.,
5813 Mission St.,
San Francisco 25, Calif.

Pacific Gun Sight Co.,
2901 El Camino Real,
Palo Alto, Calif.

Redfield Gunsight Co.,
3313 Gilpin St.,
Denver 5, Colo.

Star Gunsight Co.,
Box 112,
Stroudsburg, Pa.

Williams Gun Sight Co.,
7389 Lapeer Road,
Davison, Mich.

Special Bullets:

J. W. Hornady,
216 W. 4th St.,
Grand Island, Neb.

M.G.S. Bullet Co.,
Hollydale, Calif.

Sierra Manufacturing Co.,
600 West Whittier Blvd.,
Whittier, Calif.

Speer Products Co.,
Lewiston, Idaho.

Western Alloy Co.,
P.O. Box 643,
North Hollywood, Calif.

Western Tool & Copper Co.,
P.O. Box 856,
Oakland, Calif.

Sporting Goods:

Abercrombie & Fitch Co.,
342 Madison Ave.,
New York 17, N. Y.

Alaska Sleeping Bag Co.,
309 S.W. 3rd Ave.,
Portland 4, Ore.

L. L. Bean,
302 Main St.,
Freeport, Me.

Continental Arms Corp.,
697 Fifth Ave.,
New York 22, N. Y.

Fiala Outfits,
47 Warren St.,
New York 7, N. Y.

Firearms International Corp.,
Washington 20, D. C.

J. L. Galef & Son, Inc.,
85 Chambers St.,
New York 7, N. Y.

Hudson Sporting Goods Co.,
52 Warren St.,
New York 7, N. Y.

Klein's,
227 West Washington St.,
Chicago 6, Ill.

National Camera Exchange,
86 S. 6th St.,
Minneapolis 2, Minn.

Parker-Whelen Co., Inc.,
827 Fourteenth St., N.W.,
Washington 5, D. C.

Roberts Industries, Inc.,
4200 N. Main St.,
Branford, Conn.

Stoeger Arms Corp.,
45-47 Pearson St.,
Long Island City 1, N. Y.

Von Lengerke & Antoine,
9 N. Wabash Ave.,
Chicago 2, Ill.

Western Arms Corp.,
417 E. Pico Blvd.,
Los Angeles 15, Calif.

Spotting Telescopes:

Bausch & Lomb Optical Co.,
630 Lomb Park,
Rochester 2, N. Y.

Chester Brandon,
Box 126,
Montrose, Calif.

J. W. Fecker, Inc.,
2016 Perrysville Ave.,
Pittsburgh 14, Pa.

Tinsley Laboratories,
2524 Grove St.,
Berkeley 4, Calif.

John Unertl Optical Co.,
3551-5 East St.,
Pittsburgh 14, Pa.

Steel Tubing:

Elwood Ivins Tube Works,
Oak Lane,
Philadelphia 26, Pa.

Globe Stainless Tube Co.,
Milwaukee, Wis.

Stock Finishing Materials:

A. B. Harris,
Box 505,
Gary, Ind.

Mashburn Arms Co.,
112 West Grand,
Oklahoma City 2, Okla.

C. R. Pedersen & Co.,
Ludington, Mich.

Targets:

National Rifle Association,
1600 Rhode Island Ave., N.W.,
Washington 6, D. C.

National Target Co.,
1255 25th St., N.W.,
Washington 6, D. C.

New Trenton Targets,
P.O. Box 51,
Cincinnati 5, Ohio.

Threading Dies and Taps:

Driver Equipment Co.,
1152 Valencia St.,
San Francisco 10, Calif.

Frank S. Fickett,
232 Fowler Ave.,
San Francisco 16, Calif.

Greenfield Tap & Die Co.,
Greenfield, Mass.

Pratt & Whitney Co.,
Hartford, Conn.

Trigger Attachments:

M. H. Canjar,
4476 Pennsylvania St.,
Denver 16, Colo.

Hunting's Gun Shop,
Rt. 4, Box 486A,
New Brunswick, N. J.

Paul Jaeger,
Jenkintown, Pa.

Mashburn Arms Co.,
112 West Grand,
Oklahoma City 2, Okla.

Viggo Miller,
4340 Charles St.,
Omaha 3, Neb.

Trophies Mounted:

Joseph Bruchac,
Greenfield Center 2, N. Y.

Ventilated Ribs:

Simmons,
504 E. 18th St.,
Kansas City 6, Mo.

Woodworking Tools:

Power Tools, Inc.,
1327 Yates Ave.,
Beloit, Wis.

Rockwell Manufacturing Co.,
(Delta Power Tools)
833 E. Vienna Ave.,
Milwaukee 1, Wis.

Books Recommended for the Student:

American Machinist Hand-Book. McGraw-Hill Publishing Co., New York, N. Y.

Pistols and Revolvers. Hatcher.

Machinery Hand-Book. The Industrial Press, New York, N. Y.

Heat Treatment, Uses and Properties of Steel. Knowlton.

Steel and its Heat Treatment. Bullens.

Gas Welding and Cutting. American Welding Society.

Text-book of Advanced Machine Work. Smith.

Dies and Die Making. International Textbook Co.
Machine Tools and their Operation. Colvin & Stanley.
Military and Sporting Rifle Shooting. Capt. E. C. Crossman.

American Rifleman. Published by the National Rifle Association of America, 1600 Rhode Island Ave., N.W., Washington 6, D. C.

The Technical Division of any Public Library is a source where information can be had on any subject relating to the mechanical crafts.